

# TM 55-1520-221-10

DEPARTMENT OF THE ARMY TECHNICAL MANUAL

---

Sp/5 Tim Staats  
RA 16971208  
Cobra Armament Co  
Hunter Field, GA  
1970

**OPERATOR'S MANUAL**  
**ARMY MODEL**  
**AH-1G-HELICOPTER**

---

HEADQUARTERS, DEPARTMENT OF THE ARMY

APRIL 1967

HEADQUARTERS  
DEPARTMENT OF THE ARMY  
WASHINGTON, D. C., 10 April 1967

TM 55-1520-221-10 is published for the use of all concerned.

By Order of the Secretary of the Army:

HAROLD K. JOHNSON,  
*General, United States Army,*  
*Chief of Staff.*

Official:

KENNETH G. WICKHAM,  
*Major General, United States Army,*  
*The Adjutant General.*

DISTRIBUTION:

To be distributed in accordance with DA Form 12-31 requirements for Operator and Crew Maintenance instructions for AH-1G aircraft.

CHANGE }  
No. 2 }HEADQUARTERS  
DEPARTMENT OF THE ARMY  
WASHINGTON, D. C., 26 October 1967

## Operator's Manual

## ARMY MODEL AH-1G HELICOPTER

TM 55-1520-221-10, 10 April 1967, is changed as follows:

1. Remove and insert pages as indicated below.

	Remove pages	Insert pages
Chapter 2, section II	2-9 and 2-10 2-11 thru 2-12A 2-13 thru 2-14A 2-15 and 2-16	2-9 thru 2-10A 2-11 and 2-12 2-13 thru 2-14B 2-15 and 2-16 2-28A
Chapter 3, section II	2-29 and 2-30 3-7 and 3-8	2-29 and 2-30 3-7 thru 3-8B
Chapter 4, section IX, X, XI, XII	4-11/4-12	4-11 and 4-12
Chapter 6, section VII	6-7 and 6-8 6-15 thru 6-16A 6-17 thru 6-20 6-21 and 6-22	6-7 and 6-8 6-15 thru 6-16B 6-17 thru 6-20B 6-21 and 6-22
Chapter 14, section II	14-120	14-120

2. Retain this sheet in front of manual for reference purposes.

By Order of the Secretary of the Army:

HAROLD K. JOHNSON,  
General, United States Army,  
Chief of Staff.

Official:

KENNETH G. WICKHAM,  
Major General, United States Army,  
The Adjutant General.

## DISTRIBUTION:

To be distributed in accordance with DA Form 12-31 requirements for Operators and Crew Maintenance Instructions for AH-1G aircraft.

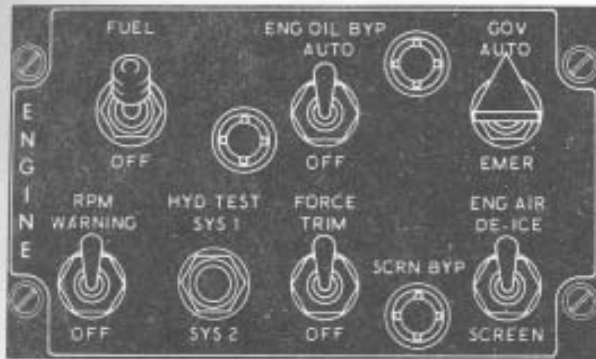

209075-6

Helicopters serial number 66-15249 through 66-15257

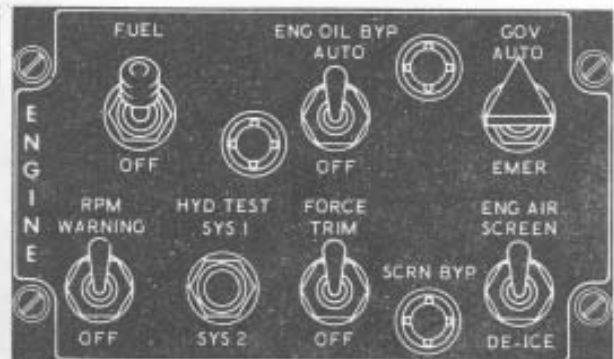

209075-6A

Helicopters serial number 66-15258 and subsequent

Figure 2-7. Engine control panel

**2-28. Fuel Control System Operation.** Fuel flow control is accomplished by operation of fuel switch located on the left console's engine control panel (see figure 2-7). The GOV AUTO/EMER switch is also located in the same panel. The engine fuel and power control system permits the pilot to obtain maximum performance from the engine with a minimum of attention.

**2-29. Emergency Fuel Flow.** The switchover to emergency fuel flow is accomplished by retarding the power control (throttle) to flight idle, moving the GOV AUTO/EMER switch to EMER, and then advancing the power control to operational rpm. The emergency control manually meters fuel to the engine without the incorporation of any automatic features. It is possible to fly the helicopter by utilizing smooth, coordinated use of the rotating power control. When operating on emergency control, it is possible to overspeed the gas producer turbine and the power turbine, and to exceed red-line tailpipe temperature.

**Note**

Retarding the power control to 70 percent gas producer rpm or flight idle detent position before switching to emergency control will effect a satisfactory changeover at any altitude. At lower altitudes (below 10,000 feet) satisfactory emergency switchover may be made by retarding the power

control until a reduction of (nII) rpm is noted and then switching to emergency.

**2-30. Power Control (Throttle).** The rotating grip-type power controls are located on the collective pitch controls (figure 2-8 and gunner's, figure 2-9). The power control is a simple single throttle grip which is used for starting engine, adjusting flight idle, autorotational landings, and in full decrease serves as fuel shut off. The throttle grip is rotated to the left to increase or to the right to decrease power. Friction can be induced into the throttle grip by rotating the ring at the upper end of the throttle grip. Rotating the ring to the left increases friction in the system and prevents grip creepage. A 28-volt dc powered solenoid-operated idle detent is incorporated in the throttle to prevent inadvertent closing of the throttle during flight or ground run. To bypass the idle detent, depress and hold the engine idle release switch until gas producer speed of 40 to 44 percent rpm is obtained, then release switch and close throttle. The idle detent limits only the decrease rotation of the rotating grip. Under normal flight conditions the power plant free power turbine rpm speed is controlled by the power turbine speed governor. The gas producer speed governor safeguards the engine against overloading; and on acceleration and deceleration, the control prevents engine damage or combustion blowout due to sudden changes in power selection made at any rate and in any sequence.



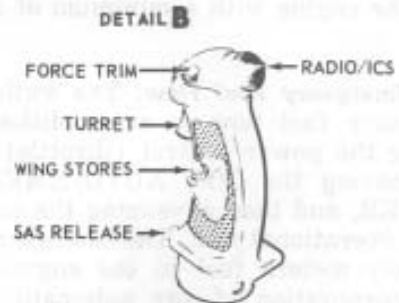
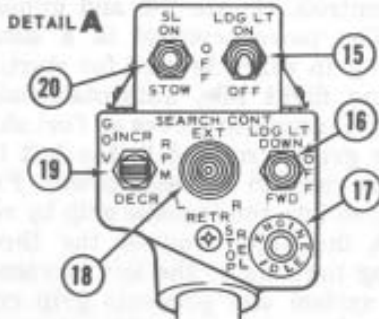
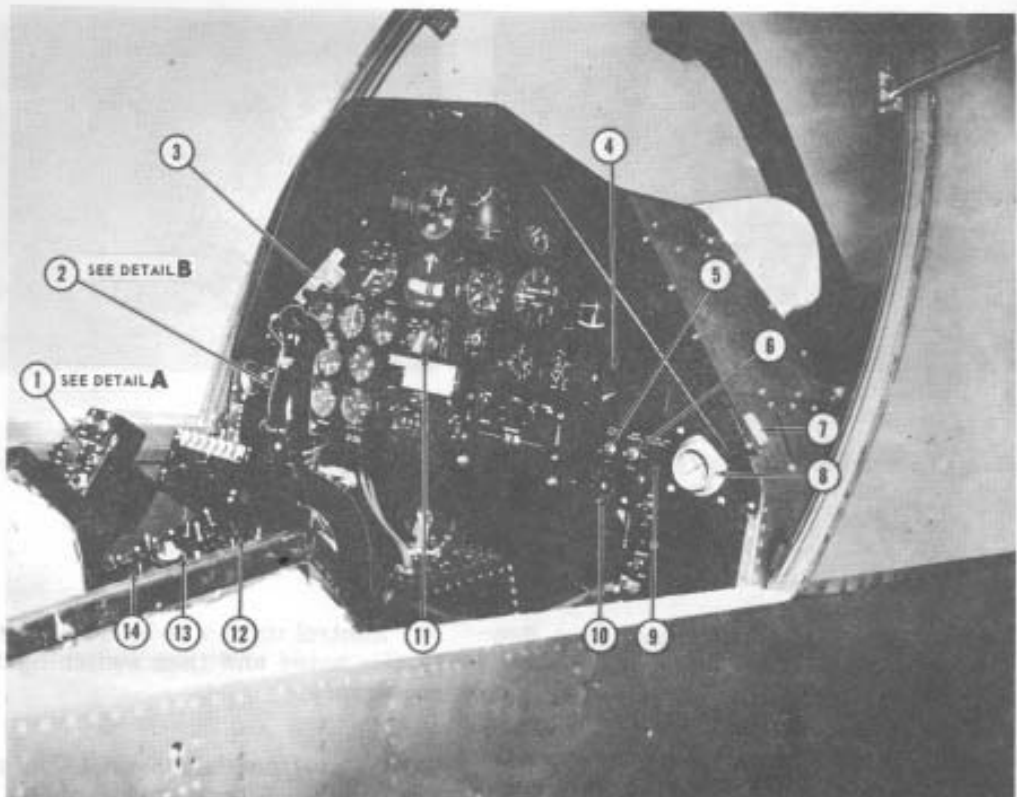

- |   |   |
|---|---|
| <ol style="list-style-type: none"> <li>1. Collective Pitch Control</li> <li>2. Cyclic Stick</li> <li>3. Go-No-Go Placard*</li> <li>4. Ash Tray</li> <li>5. Pitot Heater Switch</li> <li>6. Rain Removal - Heat Switch</li> <li>7. Defroster Outlet Control</li> <li>8. Air Vent</li> <li>9. Heat or Vent Control</li> <li>10. Heat Selector Switch</li> </ol> | <ol style="list-style-type: none"> <li>11. Wing Stores Emergency Jettison Switch</li> <li>12. Engine Control Panel</li> <li>13. Wing Stores Control Panel</li> <li>14. Turret Control Panel</li> <li>15. Landing Light Switch</li> <li>16. Landing Light DOWN-FWD Switch</li> <li>17. Engine Idle Release Switch</li> <li>18. Searchlight EXT-RETR-L-R Switch</li> <li>19. Governor RPM INCR-DECR Switch</li> <li>20. Searchlight ON-STOW Switch</li> </ol> |
|---|---|

\*Refer to Chapter 14, figure 14-5 for decal data.

209900-8A

Helicopters serial number 66-15249 through 66-15257

Figure 2-8. Pilot's station (Sheet 1 of 2)

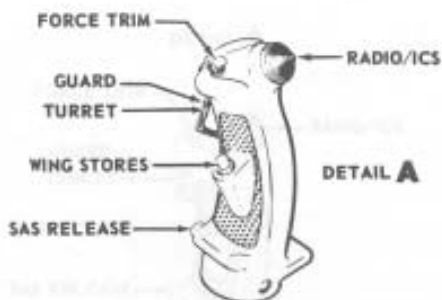
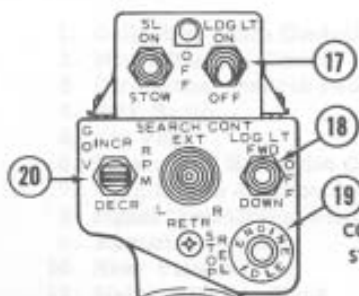
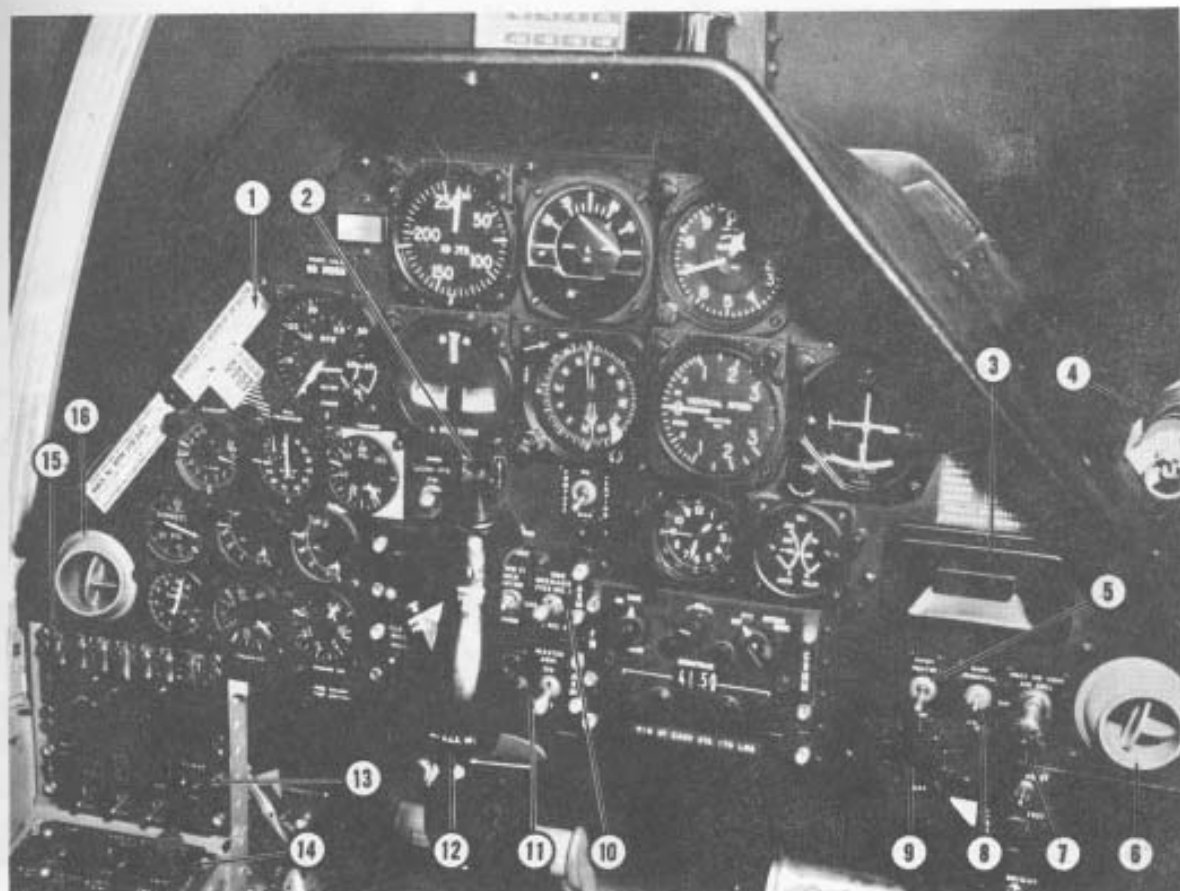

- |                                |                               |                               |
|--------------------------------|-------------------------------|-------------------------------|
| 1. Go - No - Go Placard*       | 8. Rain Removal - Heat Switch | 15. Signal Distribution Panel |
| 2. Wing Stores Jettison Switch | 9. Heat Selector Switch       | 16. Air Vent                  |
| 3. Ash Tray                    | 10. Turret Control Panel      | 17. Landing Light Switches    |
| 4. Breakout Knife              | 11. Wing Stores Control Panel | 18. Search Light Switches     |
| 5. Pitot Heater Switch         | 12. Cyclic Stick              | 19. Engine Idle Switch        |
| 6. Air Vent                    | 13. SAS Control Panel         | 20. Governor Switch           |
| 7. Heat - Vent Control         | 14. Engine Control Panel      |                               |

\*Refer to Chapter 14, figure 14-5 for decal data.

209900-8B

Helicopters serial number 66-15258 and subsequent

Figure 2-8. Pilot's station (Sheet 2 of 2)

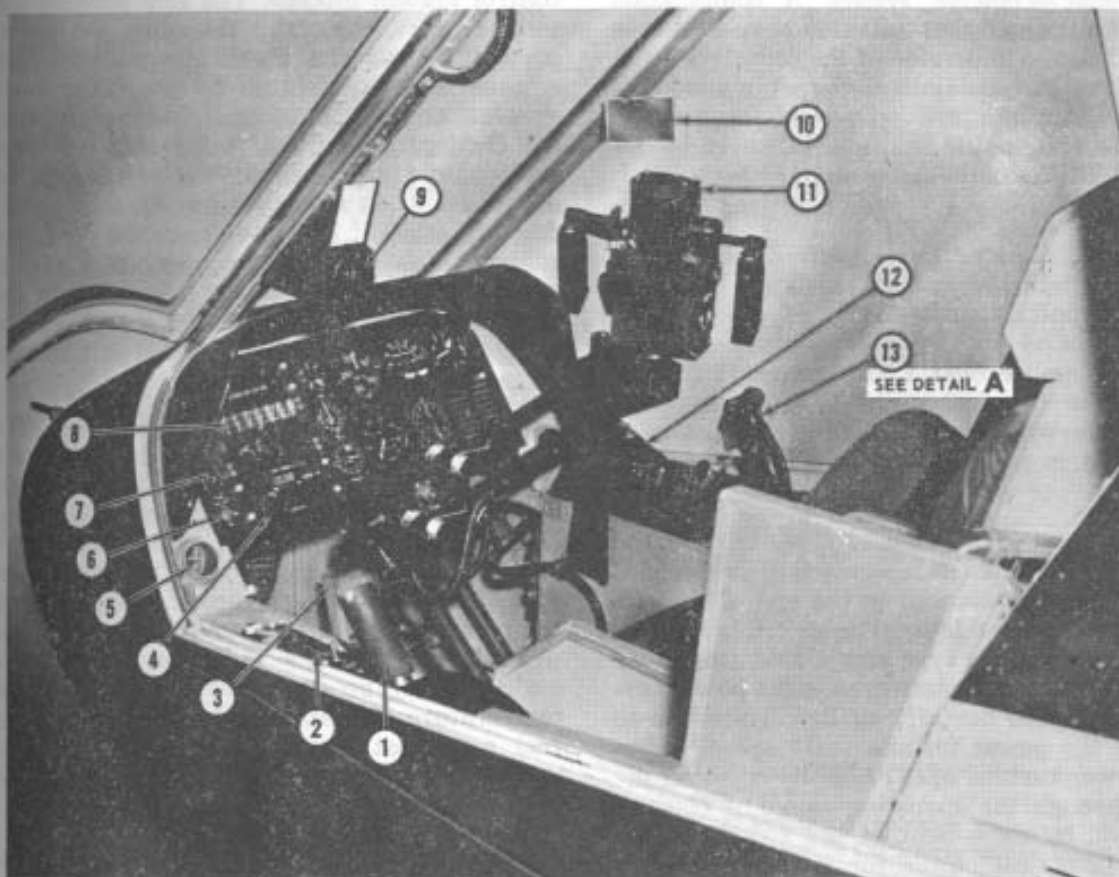

1. Collective Pitch Control
2. Miscellaneous Control Panel
3. Directional Control Pedals
4. VHF Radio
5. Air Vent
6. Emergency Hydraulic Control Switch
7. Wing Stores Jettison Switch
8. Signal Distribution Panel
9. Magnetic Compass
10. Rear View Mirror
11. Sighting Station Head
12. Armament Control Panel
13. Cyclic Stick

**DETAIL A**

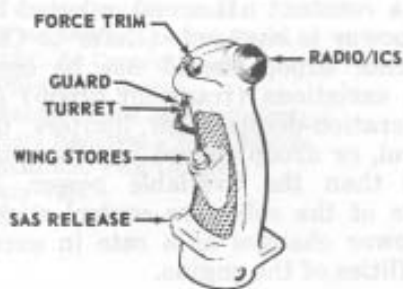

209900-7B

Helicopters serial number 66-15258 and subsequent

**Figure 2-9. Gunner's station**

**2-31. Starter — Ignition System.** A combination starter-ignition trigger-actuated snap switch is mounted on the underside of the collective pitch control switch box. Both the starter and ignition unit circuits are wired to the trigger switch as the engine ignition will only be required while accomplishing engine starts.

**2-32. Power Supply.** The circuits are supplied power from the 28 volt dc essential bus. The starter circuit is activated when the trigger switch, located on the pilot's collective pitch control, is pulled. The ignition circuit is activated when the fuel switch (see figure 2-7) is in the forward position (ON) and the trigger switch is pulled.

**2-33. Governor RPM Switch.** The GOV RPM INCR/DECR switch (see figure 2-8) is mounted in a switch box attached to the end of the collective pitch control lever. The switch is a three-position momentary type and is held (forward) in the INCR position to increase the power turbine (nII) speed or (aft) to DECR position to decrease the power turbine (nII) speed. Regulated power turbine speed may be adjusted in-flight, through the operating range of 6000 to 6600 rpm, by movement of the switch as required. Electrical power for circuit operation is supplied by the 28 volt dc essential bus.

**2-34. Droop Compensator.** A droop compensator is installed in the governor control linkage to maintain a constant nII speed, selected by the pilot, as power is changed. (Refer to Chapter 9.) Governor droop should not be confused with rpm variations (transient droop) due to the acceleration-deceleration limiters in the fuel control, or droop caused by attempting to use more than the available power. Rapid movements of the collective control stick may require power changes at a rate in excess of the capabilities of the engine.

**2-35. Engine Idle Release Switch.** The ENGINE IDLE REL switch (see figure 2-8) is a push button, momentary-on, type switch mounted in a switch box attached to the end of the collective pitch control lever. The gunner's idle release switch is located in the forward area of the left console (see figure 2-9). The pushbutton switch energizes an electrical solenoid with a retractable plunger. The solenoid is mounted so that the plunger acts as a stop in the power

control system linkage. The stop prevents the pilot from accidentally retarding the power control beyond the flight idle position. This acts as a safety feature by preventing inadvertent engine shutdown. The switch need not be depressed when performing an engine start or runup; however, the switch must be depressed when accomplishing an engine shutdown or when it is desired to retard the power control below the flight idle position. Electrical power for circuit operation is supplied by the 28 volt dc essential bus. Circuit protection is provided by IDLE STOP REL circuit breaker on the circuit breaker panel.

**2-36. Engine Instruments and Indicators.** The pilot's engine instruments and indicators are mounted in the instrument panel and the right console. The gunner's instruments and indicators are all mounted in his instrument panel. The engine instruments and indicators consist of the following: torque meter, exhaust temperature indicator, dual tachometer, gas producer tachometer indicator, oil pressure indicator, oil pressure low caution light, oil temperature indicator, fuel quantity indicator, fuel gage test switch, fuel quantity caution light, fuel pressure indicator, and engine fuel pump caution light.

**2-37. Torque Meter.** A torque meter indicator (see figure 2-10) is located on the left center area of the pilot's instrument panel and is connected to a transmitter which is part of the engine oil system. The gunner's torque meter is located at the top left area of his instrument panel (figure 2-11). The torque meter indicates torque pressure in psi readings of the torque imposed upon the engine output shaft. The torque meter circuit is powered by 26 volts ac and is protected by the TORQUE PRESS IND circuit breaker located on the circuit breaker panel mounted on the left console.

**Note**

To convert torque pressure (psig) to horsepower multiply torque X nII rpm X 0.00352.

**2-38. Exhaust Gas Temperature Indicator.** An exhaust gas temperature indicator (see figure 2-10) is located in the left area of the pilot's instrument panel. Also an exhaust gas temperature indicator (see figure 2-11) is located in the lower left area of the gunner's instrument panel. The indicator receives temperature indications from the bayonet type thermocouples mounted in the engine exhaust diffuser section.

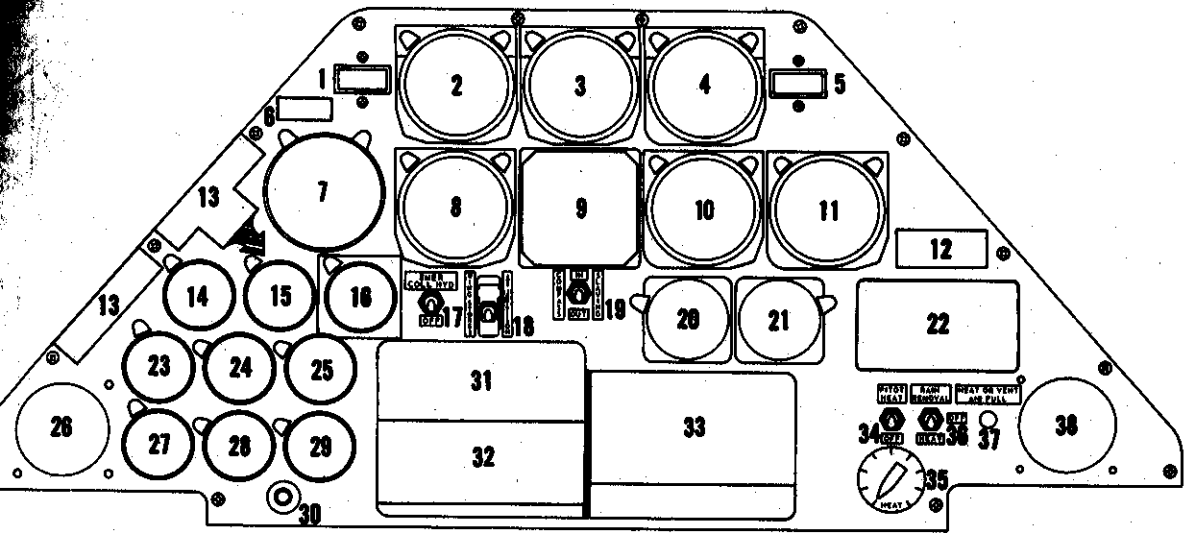

- |  |  |
|--|--|
| 1. Master Caution Light                      | 20. Clock                                  |
| 2. Airspeed Indicator                        | 21. Volt-Ammeter Indicator                 |
| 3. Attitude Indicator                        | 22. Ash Tray                               |
| 4. Altimeter                                 | 23. Fuel Pressure Indicator                |
| 5. RPM Warning Light                         | 24. Transmission Oil Temperature Indicator |
| 6. Radio Call Letters                        | 25. Engine Oil Temperature Indicator       |
| 7. Dual Tachometer Indicator                 | 26. Air Vent                               |
| 8. Turn and Slip Indicator                   | 27. Fuel Quantity Indicator                |
| 9. Radio Magnetic Indicator                  | 28. Transmission Oil Pressure Indicator    |
| 10. Rate of Climb Indicator                  | 29. Engine Oil Pressure Indicator          |
| 11. Omni Indicator                           | 30. Fuel Gauge Test Switch                 |
| 12. Transmitter Selector Decal               | 31. Turret Control Panel                   |
| 13. GO NO GO Placard*                        | 32. Wing Stores Control Panel              |
| 14. Exhaust Gas Temperature                  | 33. ARC-54 Control Panel                   |
| 15. Gas Producer Tachometer                  | 34. Pitot Heat Switch                      |
| 16. Torque Meter                             | 35. Temperature Selector Control           |
| 17. Emergency Collective Hydraulic Switch    | 36. Rain Removal - Heat Switch             |
| 18. Wings Stores Jettison Switch - Emergency | 37. Heat and Vent Control                  |
| 19. Compass Slaving Switch                   | 38. Air Vent                               |

\*Refer to Chapter 14, figure 14-5 for decal data.

209070-4B

Helicopters serial number 66-15258 and subsequent

Figure 2-10. Pilot's instrument panel

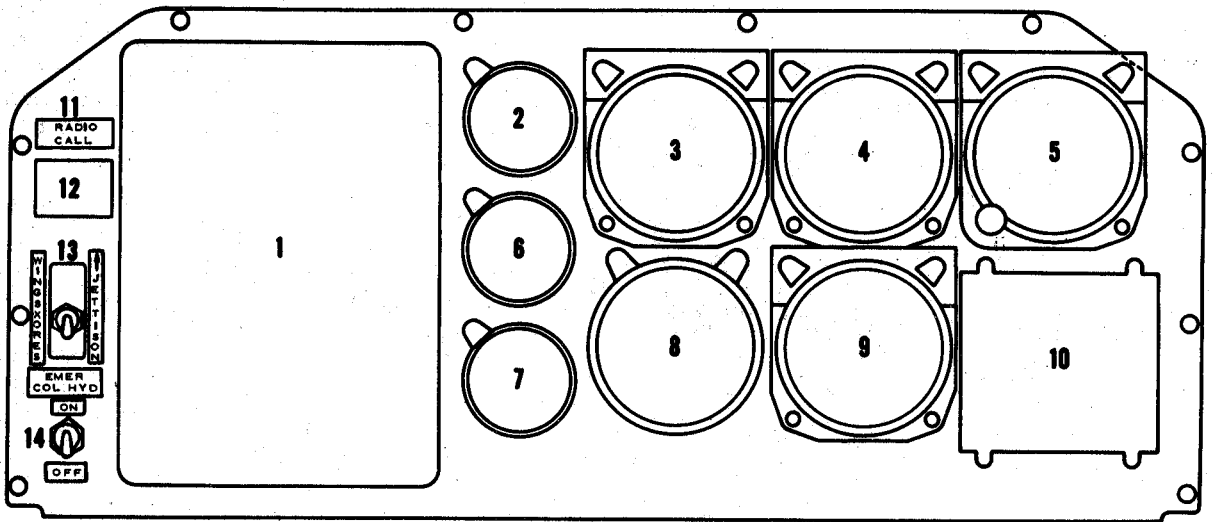

- |   |                               |   |
|---|-------------------------------|---|
| 1. Wilcox 807-A Radio and Signal Distribution Panel | 6. Gas Producer Tachometer    | 12. Interphone Panel XMTR Select Data     |
| 2. Torque Meter Indicator                           | 7. Exhaust Gas Temperature    | 13. Wing Stores Jettison Switch           |
| 3. Airspeed Indicator                               | 8. Dual Tachometer Indicator  | 14. Emergency Collective Hydraulic Switch |
| 4. Attitude Indicator                               | 9. Radio - Magnetic Indicator |   |
| 5. Altimeter  | 10. Caution Panel             |   |
|   | 11. Radio Call Letters        |   |

209070-3B

Figure 2-11. Gunner's instrument panel

The gage temperature indications are in degrees centigrade and electrical power is not required as the system is self generating.

**2-39. Dual Tachometer.** The dual tachometer (see figure 2-10) is located in the left area of the pilot's instrument panel. The gunner's dual tachometer (see figure 2-11) is located in the lower left area of his instrument panel. The indicator is for both the engine and main rotor. The outer scale of the indicator is for power turbine rpm, and the smaller inner scale is for the main rotor rpm. Power for operation of the indicators is provided by two tachometer generators mounted one on the engine and one on the transmission. These systems are self-generating, therefore a connection to the electrical system is not required. Normal operation of the helicopter is evident when the power turbine (engine) and rotor rpm indicator needles are in synchronization.

**2-40. Gas Producer Tachometer.** The gas producer tachometer (see figure 2-10), located in the left center area of the pilot's instrument panel, indicates the rpm of the gas producer turbine. The indicator is powered by a tachometer generator geared to the engine gas producer shaft and therefore does not depend on the helicopter's electrical system. The indicator readings are in percent rpm of gas producer turbine speed.

**2-41. Oil Pressure Indicator.** The engine oil pressure indicator (see figure 2-10) located in the lower left area of the pilot's instrument panel, receives pressure indications from the pressure transmitter and provides readings in psi. The oil pressure indicator and transmitter are electrically powered by the 26 volt ac system.

**2-42. Low Pressure — Caution.** One Engine OIL PRESSure caution worded segment is located

in the pilot's right console mounted CAUTION panel (see figure 2-12). Also an ENGINE OIL PRESS caution worded segment is located in the gunner's instrument panel mounted CAUTION panel. The light is connected to a low pressure switch, which makes contact upon a pressure drop below safe limits, and illuminates the caution light. The circuit is powered by 28 volt dc and is connected to the essential bus.

either pump inoperative the low level switches are connected in series. The switches function to close the circuit and illuminate the worded segment panel lights when there is enough

**2-43. Oil Temperature Indicator.** The engine oil temperature gage is located in the lower left area of the pilot's instrument panel (see figure 2-10). The gage is connected to an electrical resistance type thermocouple and indicates the temperature of the engine oil at the oil inlet. The oil temperature indicator is powered by 28 volt dc and is connected to the essential bus.

**2-44. Fuel Quantity Indicator.** The fuel quantity indicator is located in the left area of the pilot's instrument panel (see figure 2-10). This instrument is a transistorized electrical receiver which continuously indicates the quantity of fuel in pounds and is powered by the 115 volt ac system and circuit protection is provided by a circuit breaker on the circuit breaker panel. The fuel quantity indicator is connected to capacitor-type fuel quantity transmitters in the forward and aft fuel cells. The indicator readings shall be multiplied by 100 to obtain fuel quantity in pounds.

**2-45. Fuel Gauge Test Switch.** A push-button momentary ON switch (see figure 2-10) is located in the left area of the pilot's instrument panel. The switch functions to provide a means of testing the indicator and circuit for operation. When the switch button is DE-PRESSED and HELD IN, the fuel quantity indicator pointer moves from the actual quantity reading toward a lesser quantity reading. Upon release of the test button the indicator needle will return to the actual fuel reading.

**2-46. Fuel Quantity Caution Light.** A caution panel segment worded 10% FUEL is located in the pilot's caution panel (see figure 2-12) and the gunner's caution panel (see figure 2-11). The light switch assembly is located in each fuel cell through a low fuel level relay. With both pumps operating the low level switches are connected in parallel and with



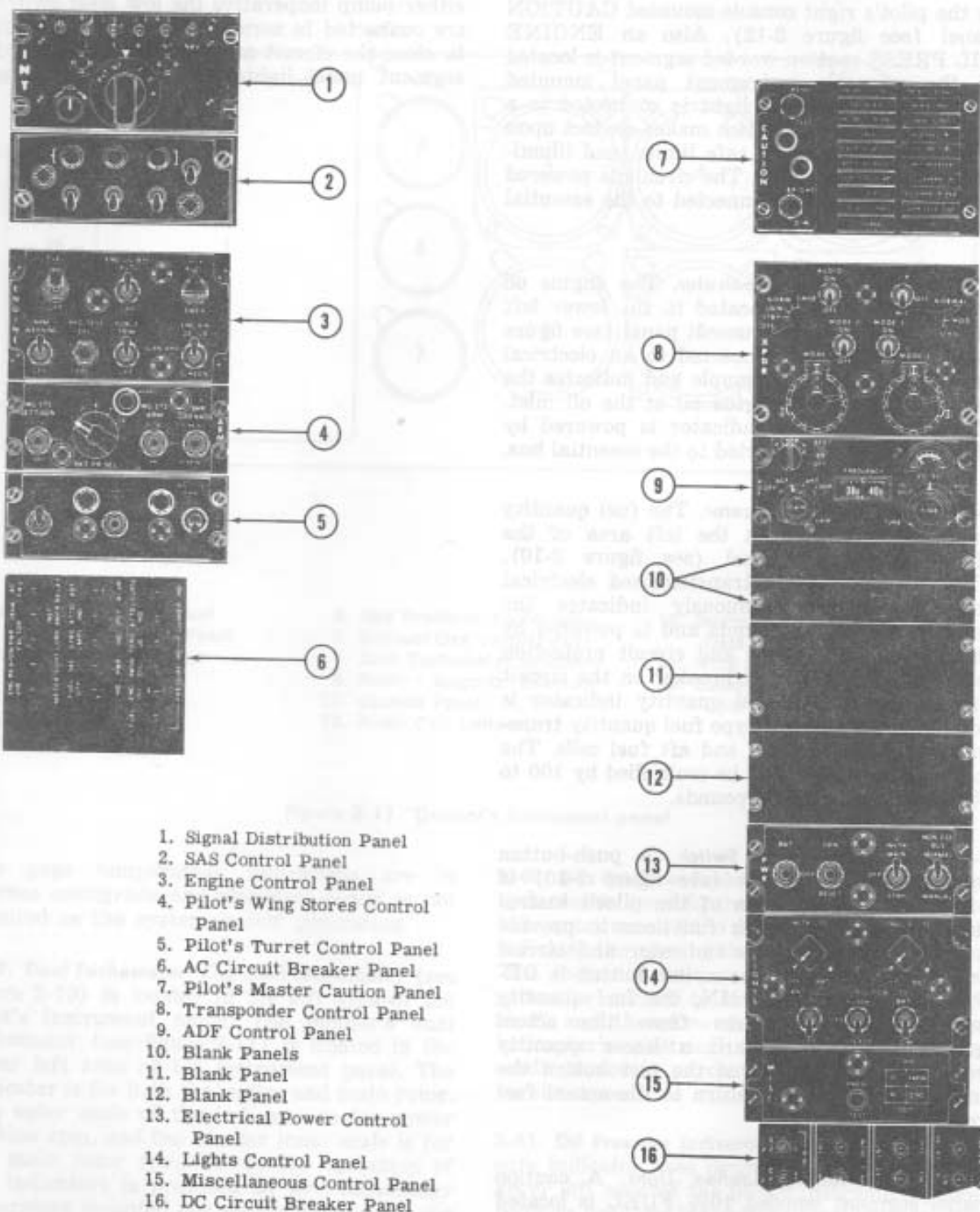

1. Signal Distribution Panel
2. SAS Control Panel
3. Engine Control Panel
4. Pilot's Wing Stores Control Panel
5. Pilot's Turret Control Panel
6. AC Circuit Breaker Panel
7. Pilot's Master Caution Panel
8. Transponder Control Panel
9. ADF Control Panel
10. Blank Panels
11. Blank Panel
12. Blank Panel
13. Electrical Power Control Panel
14. Lights Control Panel
15. Miscellaneous Control Panel
16. DC Circuit Breaker Panel

209075-10A

Helicopters serial number 66-15249 through 66-15257

Figure 2-12. Pilot's consoles (Sheet 1 of 2)



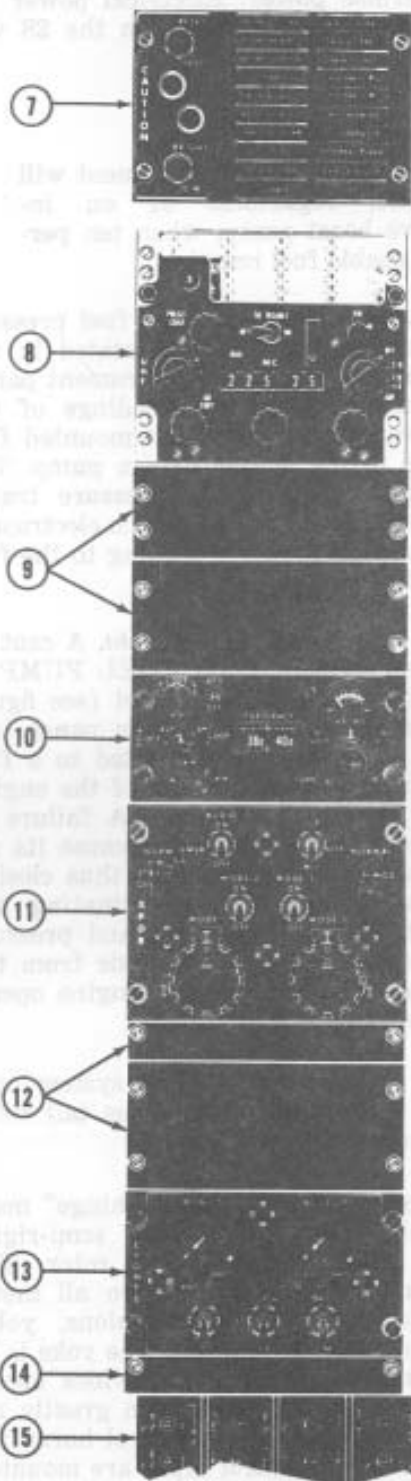
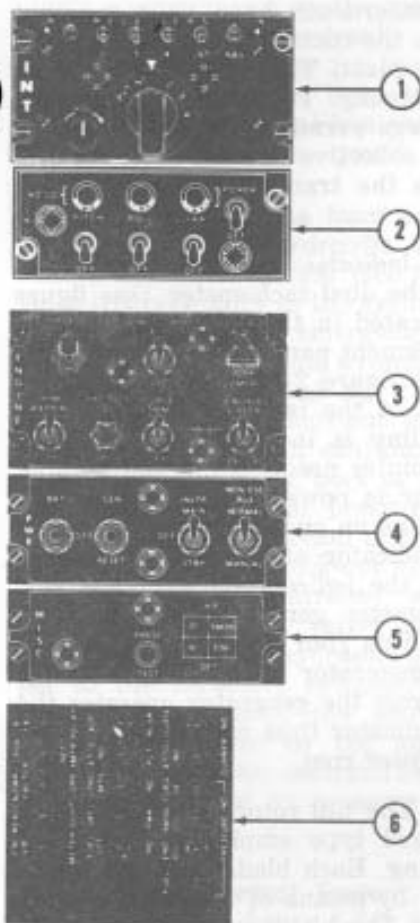

209075-10C

1. Signal Distribution Panel
2. SAS Control Panel
3. Engine Control Panel
4. Electrical Power Control Panel
5. Miscellaneous Control Panel
6. AC Circuit Breaker Panel
7. Pilot's Master Caution Panel
8. ARC-51 BX UHF Control Panel
9. Blank Panels
10. ARN-83 ADF Control Panel
11. APX-44 Transponder Control Panel
12. Blank Panels
13. Lighting Control Panel
14. Blank Panel
15. DC Circuit Breaker Panel

Helicopters serial number 66-15258 and subsequent

Figure 2-12. Pilot's consoles (Sheet 2 of 2)

fuel remaining for approximately 20 minutes of fuel at cruise power. Electrical power for circuit operation is derived from the 28 volt dc essential bus.

**Note**

The 10% FUEL caution segment will illuminate, regardless of an in-operative boost pump, when ten percent of usable fuel remains.

**2-47. Fuel Pressure Indicator.** The fuel pressure indicator (see figure 2-10) is located in the lower left area of the pilot's instrument panel. This indicator provides psi readings of the fuel as delivered from the tank mounted fuel boost pumps to the engine driven pump. The indicator is connected to a pressure transmitter, powered by 26 volt ac, which electrically transmits the fuel pressure reading to the fuel pressure indicator.

**2-48. Engine Fuel Pump Caution Light.** A caution panel worded segment ENG FUEL PUMP is located in the pilot's caution panel (see figure 2-12) and in the gunner's caution panel (see figure 2-11). The light is connected to a fuel pressure switch at each element of the engine driven dual element fuel pump. A failure of either engine pump element will cause its respective pressure switch to close, thus closing the electrical circuit and illuminating the caution light. The caution light and pressure switches are powered by 28 volt dc from the essential bus. Sufficient fuel for engine operation is delivered by either element.

**2-49. Rotor System.** The rotor system consists of the main rotor, anti-torque tail rotor and rotor tachometer.

**2-50. Rotor System.** The 540 "door hinge" main rotor assembly is a two bladed semi-rigid, underslung feathering axis type rotor. The assembly consists basically of two all metal blades, blade grips, yoke extensions, yoke, trunnion, and rotating controls. The yoke is of flat steel plate design, which provides necessary inplane stiffness. This design greatly reduces 2/rev. vibrations. The control horns for cyclic and collective control input are mounted on the trailing edge of the blade grip. Blade centrifugal loads are transferred from the blade grips to the extensions by wire wrapped type tension-torsion straps. The main rotor is mounted on the first set of splines from the

top of the mast by the trunnion. The trunnion is supported underneath by a split cone set and retained on the mast by a nut threaded to the top of the mast. The trunnion bearings permit rotor flapping. The blade grip to yoke extension bearings permit cyclic and collective pitch action. A collective friction device is provided to reduce the transient relative oscillation between the mast and collective sleeve.

**2-51. Rotor RPM Indicator.** The rotor rpm indicator is part of the dual tachometer (see figure 2-10) and is located in the upper left area of the pilot's instrument panel. The gunner's dual tachometer (see figure 2-11) is located in the lower left area of the instrument panel. The rotor rpm reading is indicated on the inner scale and the pointer needle is marked with an R. The indicator is powered by a tachometer generator mounted on and driven by the transmission. The indicator and generator operate independent of the helicopter's electrical system. The tachometer generator is a variable output type, and as rpm changes, the current output of the generator varies. The variable output power from the generator operates the motor in the indicator thus providing a direct reading of the rotor rpm.

**2-52. Tail Rotor.** The tail rotor is a two bladed, soft, delta hinged type employing preconing and underslinging. Each blade is connected to a common yoke by means of a grip and pitch change bearings. The blade and yoke assembly is mounted on the tail rotor shaft by means of delta-hinge trunnion to minimize rotor flapping. Blade pitch is altered by movement of the tail rotor control pedals to control or maintain heading. This blade pitch change provides control of torque and change of direction heading. Power to drive the tail rotor is supplied from a take-off on the lower end of the main transmission.

**2-53. Transmission System.** The transmission is mounted forward of the engine and coupled to the engine by means of a short drive shaft. The transmission is basically a reduction gear box functioning to transmit engine power, at a reduced rpm, to the main and tail rotors by means of a two-stage planetary gear train. The transmission incorporates a freewheeling unit at the input drive, which provides a disconnect from the engine in case of a power failure and permits the main rotor and tail rotor to rotate in order to accomplish safe autorotational landings. The tail rotor is powered by take-off on the lower

and "HYD PRESS NO. 2" are located in the pilot's and gunner's caution panel. The panels illuminate when the hydraulic system pressure is low. Electrical power for the hydraulic pressure caution indicator light is supplied from the 28 volt dc essential bus and circuit protection is provided by a circuit breaker on the circuit breaker panel.

**2-95. Secondary Hydraulic System.** The secondary hydraulic system (see figure 2-23) provides irreversibility in the cyclic control system and limited duration emergency power for the collective system. Should a condition arise where both systems No. 1 and No. 2 become inoperative, the up-stream lock-out valve and spring loaded accumulator in conjunction with check valve located at inlet port of each cyclic cylinder provides partial pressurization of each cyclic cylinder. Up-stream of the collective cylinder, a pressurized lock-out valve, charged accumulator, pilot controlled electric solenoid valve and two check valves are provided and arranged to provide hydraulic oil stored at 1500 psi to the collective cylinder. During normal boost on operations, the accumulator is hydraulically charged by the number 1 system hydraulic pump. An electrical switch is provided to allow the pilot to conserve the stored hydraulic power.

**2-96. Flight Control System.** The flight control system (see figure 2-24) is a positive mechanical type, actuated by conventional helicopter controls which when moved, direct the helicopter in various modes of flight. Complete flight controls are provided for both pilot and gunner. The system includes; the cyclic control stick, used for fore and aft and lateral control; the collective pitch (main rotor) control lever, used for vertical control; tail rotor (directional) control pedals, used for heading control; and a

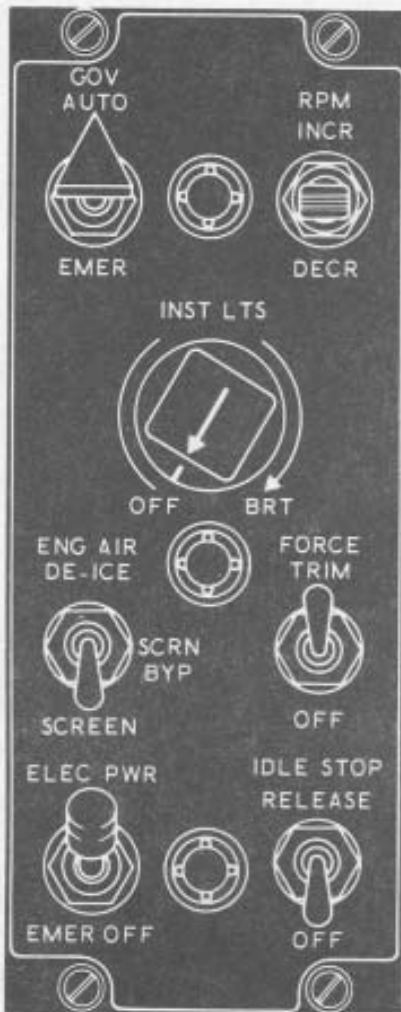

209075-5A

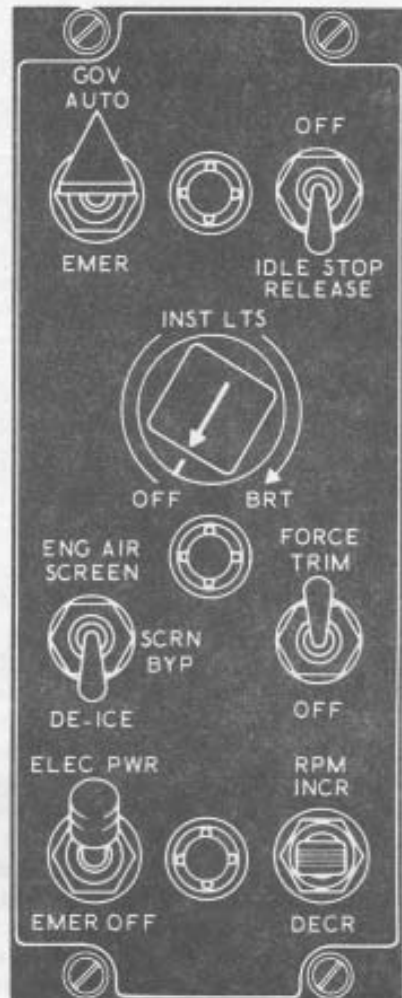

209075-5B

Helicopters serial number 66-15249 through 66-15257

Helicopters serial number 66-15258 and subsequent

Figure 2-20. Gunner's miscellaneous control panel

synchronized elevator, to increase controllability and lengthen CG range. The control forces of the flight control system are reduced to a near zero pounds force, to lessen pilot fatigue, by hydraulic servo cylinders connected to the control system mechanical linkage and powered by the transmission driven pumps. Force trims (force gradient) connected to the cyclic and directional controls are electrically operated mechanical units; used to induce artificial control feeling into the cyclic and directional controls and to prevent the cyclic stick and directional controls from moving of their own accord.

**2-97. Force Trims (Force Gradient).** Force gradient devices are incorporated in the cyclic control and directional pedal controls. These devices are installed in the flight control system between the cyclic stick and the hydraulic power cylinders, and between the directional pedals and the hydraulic power cylinder. The devices act to furnish a force gradient or "feel" to the cyclic control stick and directional control pedals, however, these forces can be reduced to zero by depressing the left button (see figure 2-8) on top of the cyclic control stick. The gradient is accomplished by means of springs and magnetic brake release assemblies which

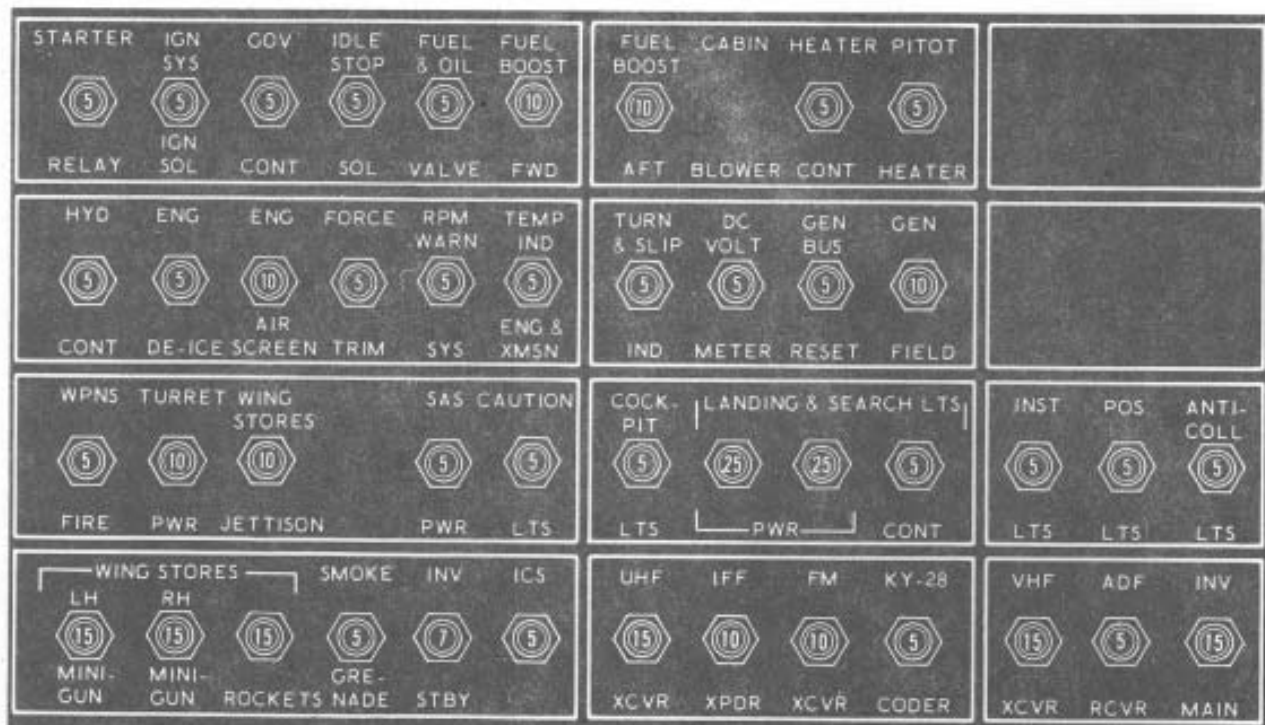

209075-11A

Figure 2-21. DC circuit breaker panel

enable the pilot to trim the controls, as desired, for any condition of flight. A force trim toggle type switch is installed in the engine control panel (see figure 2-7) to activate the force trim system. The force trim units provide the pilot with a 100 percent trim authority.

**2-98. Crew Compartment Controls.** The pilot's controls are of the conventional helicopter controls. The gunner's cyclic and collective controls are side arm controls that are operated with less motion than the pilot's controls.

**2-99. Cyclic Control Stick.** The pilot's cyclic stick grip contains a two-position trigger switch for the turreted gun, radio two-position switch, force trim switch, SAS release switch and a switch for firing the wing mounted weapons (see figure 2-8). The gunner's cyclic stick grip contains a two-position trigger switch for guns, force trim switch, two position radio switch, SAS release switch and wing stores firing switch. The pilot's cyclic stick has a built-in operating friction. The cyclic control movements are not mixed, but are transmitted directly to the swashplate. The fore and aft

cyclic control linkage is routed from the cyclic stick through the SAS actuator, the dual boost hydraulic actuator to the right horn of the fixed swashplate ring. The lateral is similarly routed to the left horn. Control "feel" is provided by the force trim units.

**2-100. Collective Pitch Control Lever.** The pilot's collective pitch control lever (see figure 2-8) is located to the left of the pilot's position and controls the vertical mode of flight. Desired operating friction can be induced into the control lever by hand tightening the friction adjuster. A rotating grip-type throttle and a switch box assembly are located in the upper end of the pilot's collective pitch lever. The switch box assembly contains the starter, governor, engine idle release, landing light switches and search light switches. A spring loaded pitch lever down lock is located on the console at the approximate center of the lever. The gunner's collective stick is located on the gunner's left console and is operated with wrist motion. No switches are installed on the gunner's collective control.

increasing power to maximum available torque pressure (not to exceed redline) and assume a 40 knot airspeed attitude. As power is increased, maintain heading by smoothly coordinating tail rotor pedals. When sufficient altitude for obstacle clearance is obtained, smoothly increase airspeed and reduce power to establish a normal climb.

**Note**

The bleed air heater (RAIN REMOVAL-HEAT switch) should be in the OFF position during take-off, landing and other flight conditions requiring maximum engine power available.

**3-25. Crosswind Take-Off.** In the event a crosswind take-off is required, normal take-off procedures are used. As the helicopter leaves the ground, there will be a definite tendency to drift downwind. This tendency can be corrected by holding the cyclic stick into the wind a sufficient amount to prevent downwind drift. When a crosswind take-off is accomplished, it is advisable to turn the helicopter into the wind for climb as soon as obstacles are cleared and terrain permits.

**Warning**

The AH-1G helicopter, with the tail rotor rigged at 19° blade angle for full left pedal, has limited directional control authority which under certain wind and gross weight conditions results in the inability to maintain heading or to maneuver the aircraft. Consequently, operation of the helicopter in a hover, as well as approaches to a hover, in confined areas with the wind in the aft to left quadrant (see figure 3-1A) must be avoided.

Use of full left pedal in making hovering turns to the left or in arresting right turn rates should be avoided. The above constraints are necessary to minimize the possibility of damage to the tail rotor drive system.

In the event conditions of inadequate directional control are inadvertently encountered, control of the aircraft can be regained by allowing the aircraft to rotate clockwise into the wind while

maintaining constant rotorspeed, collective pitch and engine power.

Under no conditions should the tail rotor pitch setting be adjusted to values greater than 19° since drive system damage may occur at higher pitch settings.

**3-26. After Take-Off.** As the helicopter accelerates from hovering flight to flight in any direction, it passes through a transitional period. If engine power, RPM, and collective pitch are held constant in calm air, a momentary settling will be noted when the cyclic control stick is moved forward to obtain forward speed. This momentary settling condition is a result of the helicopter moving from the ground cushion and the tilting of the tip-path plane of rotation of the main rotor blades to obtain forward airspeed. Wind velocity at the time of take-off will partially eliminate this settling due to the increased airflow over the main rotor blades. As wind velocity increases, this settling will be less pronounced. After the helicopter accelerates forward to 10 to 15 knots airspeed, less power is required to sustain flight due to increase in aerodynamic efficiency as airspeed is increased to best climbing speed. Take-off power should be maintained until a safe autorotative airspeed is attained, then power may be adjusted to establish the desired rate of climb.

**3-27. Climb.** During climbs at low altitude a safe autorotative airspeed should be maintained so that in the event of engine failure, sufficient but not excessive airspeed is available to accomplish a safe autorotative landing. Airspeeds to avoid at low altitudes are shown on figure 7-3. If necessary to clear ground obstructions after take-off, vertical climbs can be accomplished; however, operation within the shaded area on figure 7-3, should be kept to a minimum. Accelerating the helicopter to the optimum climbing airspeed, in a shallow climb, eliminates critical settling and the possibility of the helicopter striking the ground on take-off.

**3-28. Cruise Checks.** These checks consist of constantly monitoring instruments, to be cognizant of any change in performance or condition.

**3-29. Flight Characteristics.** The helicopter is capable of delivering a maximum thrust commensurate with rotor-engine limitations and



the density altitude in which it is operating. Maximum thrust can be utilized to obtain maximum airspeed, optimum rate of climb or at some reduced airspeed, the maximum maneuver potential. The capabilities of the helicopter may be employed with maximum limitations and in accordance with the environment under which operated. The capabilities of the helicopter in stabilized flight conditions are clearly and accurately defined in Chapter 7, and Chapter 14.

**3-30. Before Landing Check.** Before landing accomplish following check.

- a. Alert gunner.
- b. Collective Friction — ADJUST.
- c. Engine RPM — 6400 to 6600 RPM.
- d. Instruments — CHECK WITHIN OPERATING LIMITS.
- e. Shoulder Harness — Lock (Pilot and Gunner).
- f. Armament switches — As required.

**3-31. Approach and Landing Procedures.** Before approach and landing are accomplished, the pilot should evaluate the landing site for suitability of usable area by making a low speed pass into the wind over the intended landing site. Evaluate terrain, check wind direction, velocity and consistency. The gross weight of the helicopter must be considered; and the final step in evaluation of a landing, is the anticipated helicopter performance during landing and subsequent take-off.

**3-32. Normal Approach.** (See figure 3-2.) The objective of a normal approach and landing is to bring the helicopter to a hover over the spot of intended landing. The airspeed is decreased gradually and a constant approach angle of 8 to 10 degrees established at an engine speed of 6600 rpm. In case of undershooting or overshooting, the approach angle is corrected by increasing or decreasing the power and the collective pitch. As the landing spot is approached the airspeed and the rate of descent are decreased in order to attain a hovering attitude at approximately three feet.

**3-33. Steep Approach.** The steep approach procedure is a precision, power-controlled approach used to clear obstacles and to accomplish a

landing in confined areas. The rate of descent in a steep approach should not exceed approximately 400 fpm with a constant approach angle of 12 to 15 degrees and some forward airspeed should be maintained at all times. Since a reasonable amount of power will be required to control the rate of descent (power required is governed by the gross weight and atmospheric conditions) a minimum amount of additional power will remain to accomplish a hover. The airspeed is decreased by holding the cyclic stick aft. The rate of descent is controlled by proper application of power and collective pitch. In the final stages of approach, the collective pitch is increased gradually and the cyclic stick is adjusted to maintain the originally established glide angle in a way which will reduce the rate of descent to zero the moment the hovering altitude is reached.

**Caution**

Never reduce forward airspeed to zero before reaching hovering altitude. If the landing spot has been overshot, execute a go-around immediately.

**Warning**

Due to lag in acceleration, which is inherent in turbine engines, a need for power should be anticipated in time to allow for the acceleration lag. As much as a four second delay may be encountered from low power (bottom pitch) to full power.

**3-34. Normal Landing.** With an engine rpm at 6400 to 6600, decrease collective pitch to effect a constant, smooth rate of descent until touchdown, making necessary corrections with pedals and cyclic control to maintain level attitude and constant heading and to prevent movement over the ground. Upon contact with the ground, continue to decrease collective pitch smoothly and steadily until the entire weight of the helicopter is resting on the ground.

**3-35. Slope Landing.** Make the slope landing by heading the helicopter generally cross-slope. Slope landing should be made cross-slope with skid type gear. Descend slowly, placing the up-slope skid on the ground first. Coordinate reduction of collective pitch with lateral cyclic (into the slope) until the downslope skid touches the ground. Continue coordinating reduction of collective pitch and application of

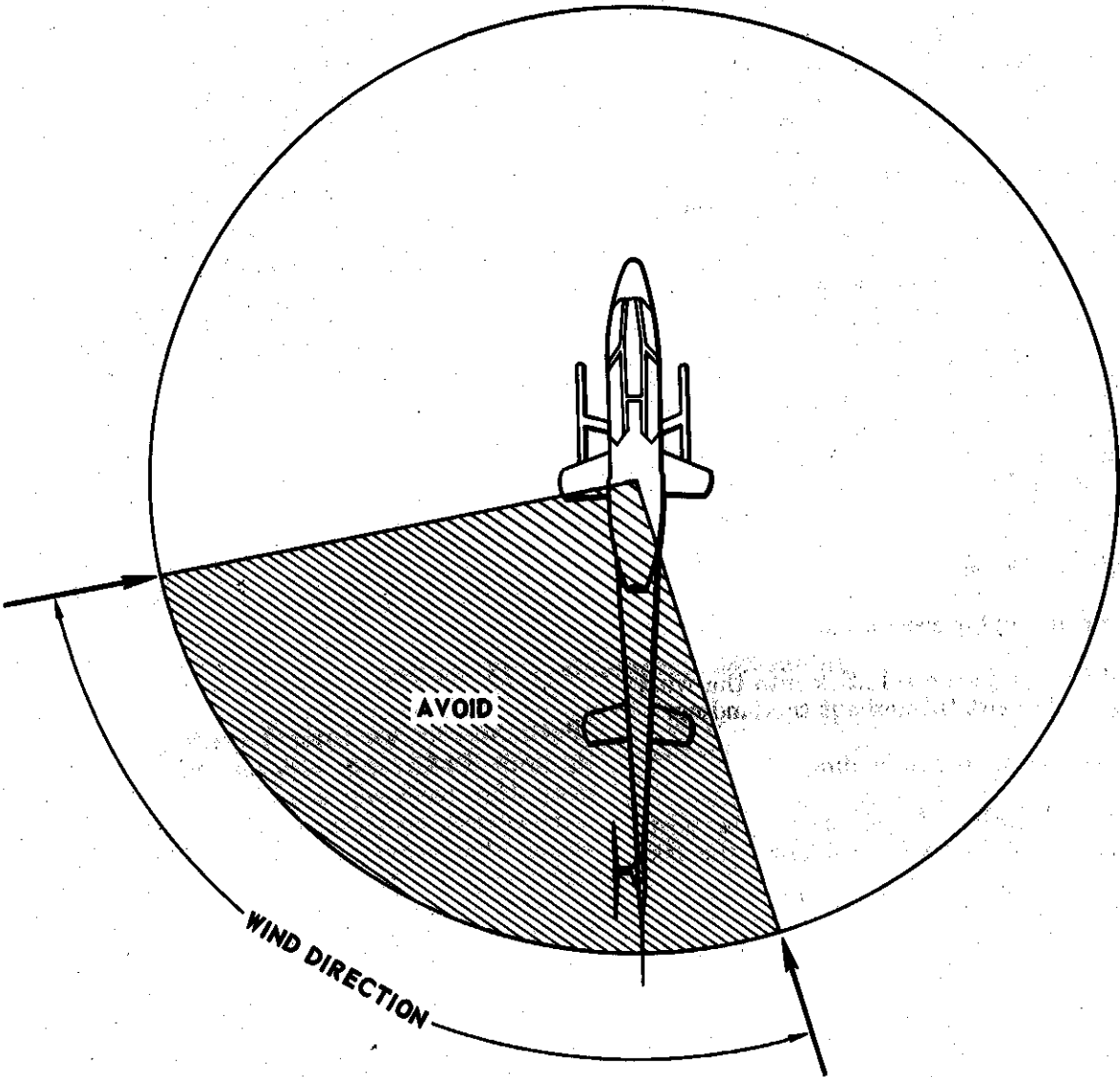

**WIND DIRECTIONS WHICH MUST BE AVOIDED  
DURING HOVER AND APPROACHES TO A HOVER**

209900-29

**Figure 3-1A. Hovering limitations (wind direction)**



cyclic into the slope until all the weight of the aircraft is resting firmly on the slope. If the cyclic control contacts the stop before the downslope skid is resting firmly on the ground, return to hover, and select a position where the degree of slope is not so great. After completion of a slope landing, and after determining that the aircraft will maintain its position on the slope, place the cyclic stick in neutral position.

**3-36. Crosswind Landing.** Crosswind landings can generally be avoided in helicopter operations. Occasionally, plowed, furrowed or eroded fields, and narrow mountain ridges may require that crosswind landings be made. The crosswind landing, in such instances where terrain features dictate, is utilized to prevent landing at a high tipping angle or dangerous tail low attitude. Crosswind landing may also be accomplished on smooth terrain when deemed advisable by pilot. The following procedures should be observed in accomplishing crosswind landing:

- a. Engine RPM 6600.
- b. Hover helicopter crosswind.
- c. Hold the cyclic control stick into the wind to prevent side drift throughout the landing.
- d. Proceed as in normal landing.

**3-37. After Landing Check.** The engine post-flight check shall be performed after the last

## Section IX — Flight Controls

**4-38. Flight Control Failure.** The flight control system is a mechanical type with hydraulic servo cylinders connected into the fore and aft cyclic, lateral cyclic, collective and the directional control system. The servo cylinders are installed solely to reduce control forces and lessen pilot fatigue. The design of the control

system's mechanical linkage is sturdy, control movements are positive and the possibility of failure is remote; therefore, an emergency system has not been provided. See hydraulic system failure (Section VII) for hydraulic system failure data. See SAS system failure (Section XII) for SAS system failure data.

## Section X — Bail Out

**4-39. Bail Out.** Helicopter design, flight characteristics and autorotation qualities reduce the necessity for bail out, however, if a decision is made to bail out, accomplish as follows:

a. Warn gunner of intent.

b. Reduce airspeed to approximately 20 knots, if canopy hatches are to be jettisoned.

c. Jettison canopy hatches.

(1) Rotate door handle up.

(2) Rotate jettison handle inboard.

(3) Push door out.

d. Set controls to establish cruise forward speed, nose slightly down, flight attitude.

e. Bail out when ready.

### Warning

Delay opening of parachute until well clear of helicopter.

## Section XI — Emergency Jettisoning

**4-40. Wing Stores Emergency Jettison.** (Helicopters serial number 66-15249 through 66-15257.) The pilot is provided with electrical jettisoning and emergency electrical jettisoning. The gunner is provided with emergency electrical jettisoning. An emergency jettison switch is located on each instrument panel. To jettison: Wing Stores Jettison switch — UP position.

### Note

Emergency Jettison operates with battery switch in either position.

The emergency jettison circuit contains a time delay for the inboard stores. The outboard stores are jettisoned first and the inboard stores are jettisoned one-half second later.

**4-41. Wing Stores Jettison** (Helicopters serial number 66-15258 and subsequent). The pilot is provided with a WG ST JETTISON SELECT switch (wing stores armament panel) and a WING STORES JETTISON switch (instrument panel). The gunner is provided a WING STORES JETTISON switch that is located on his instrument panel.

a. WG ST JETTISON SELECT switch — As required.

b. WING STORES JETTISON switch — UP position.

### Note

With the WG ST JETTISON SELECT switch in BOTH all wing stores are salvo jettisoned by the guarded WING STORES JETTISON switch regardless of battery switch position (ON or OFF).

With the WG ST JETTISON SELECT switch in INBD or OUTBD electrical power must be ON and WING STORES JETTISON switch actuated up.

The gunner's WING STORES JETTISON switch salvo jettisons both INBD and OUTBD stores regardless of the pilot's WG ST JETTISON SELECT switch position. The gunner's jettison operates with battery switch in either position.

## Section XII — Stability Augmentation System

### 4-42. Stability Augmentation System (SAS)

**Failure.** Hardover failure of a Stability Augmentation System Actuator. A hardover failure of a SAS Actuator will be evident by an abrupt change in pitch, roll or yaw attitude which, when corrected by the pilot will result in an abnormal cyclic or pedal position. If a hardover failure occurs, proceed as follows:

a. Controls — Adjust to obtain a level flight, zero sideslip condition.

b. Airspeed — Adjust to a value below the speed for maximum level flight speed.

c. SAS disengage button — Press.

#### Note

Steps a. through c. may be accomplished simultaneously. After aircraft attitude and airspeed control has been re-established, the pilot may re-engage the unaffected SAS channels, if desired. Airspeed limits with the SAS OFF are the same as with SAS ON and the decision to continue the flight with any or all of the channels disengaged is dependent upon the pilot's experience.

(GAU-2B/A) 115 degrees left and right of the forward position. Gun elevation is variable from 15 to 25 degrees, depending on the azimuth position of the turret. Gun depression is 50 degrees at all azimuth positions.

6-31. The sighting station consists essentially of a simple compensating sight head and hand grip assembly attached to the aircraft floor. The sighting station, mounted in the gunner station forward of the gunner, allows the gunner to train and fire the gun. Air data sensor input and estimated range data are fed to azimuth and elevation resolver and amplifier circuits within the sighting station to provide gross correction due to aircraft speed.

6-32. The gunner's control panel contains the controls and indicators required by the gunner to operate and monitor the system. The control panel is located in the gunner station in the right deck forward of the flight controls.

6-33. The electronic control subassembly contains the azimuth and elevation amplifiers, power supplies, dither and coincidence circuits, and control circuits required to operate the system. The electronic control subassembly is located below the gunner's control panel. Electrical power for the armament system is supplied by the 28 volt dc non-essential bus.

6-34. The ammunition feed system consists basically of ammunition storage boxes, a crossover assembly, a flexible ammunition feed chute, and a synchronized cartridge drive assembly. The ammunition stowage boxes are mounted in the aircraft aft of the turret. The flexible feed chute guides the ammunition from the stowage boxes to the gun feeder. The cartridge drive assembly is connected by a flexible shaft to the gun drive. The flexible shaft synchronizes the transportation of cartridges to the gun.

6-35. The pilot's armament control panel is not a part of the TAT-102A Armament Subsystem; however, the gun may be fired in the stowed position from the pilot station.

6-36. **Gunner's Control Panel.** The gunner's control panel (figure 6-5) contains the controls and indicators necessary to operate and monitor the armament system. Emergency provisions on the control panel are available for the gunner to take command and fire the system in case the pilot is disabled.

a. Controls. Following is a list of gunner's control panel controls and their functions:

(1) **TURRET POWER Switch.** The TURRET POWER switch, when placed in the fwd position, energizes the azimuth and elevation stow lock release solenoids which mechanically unstow the turret. The switch also energizes the turret power relay to provide plus 28 volt dc and minus 28 volt dc to the system and applies 28 volt dc to the contacts of the action and compensation switches in the sighting station. The turret power indicator illuminates (green) when the TURRET POWER switch is placed in the forward position.

(2) **TURRET MODE Switch.** The TURRET MODE switch, when placed in the AREA position, energizes a circuit which causes the gun to oscillate 60 mils in azimuth about its trained position. Placing the switch in the POINT position de-energizes the circuit and allows the gun to remain stable in its trained position.

(3) **AMMO FIREOUT Switch** — The last round switch in the ammunition box crossover chute opens when the last round of ammunition passes over the switch, thereby interrupting the electrical signal to the gun drive control valve. The rounds remaining in the crossover and flexible chute facilitate the reloading of ammunition. In an emergency, the ammunition remaining in the crossover and flexible chute may be fired by placing the AMMO FIREOUT switch to the fwd position. This permits the electrical signal to bypass the last round switch and allows the remaining rounds to be fired.

(4) Deleted

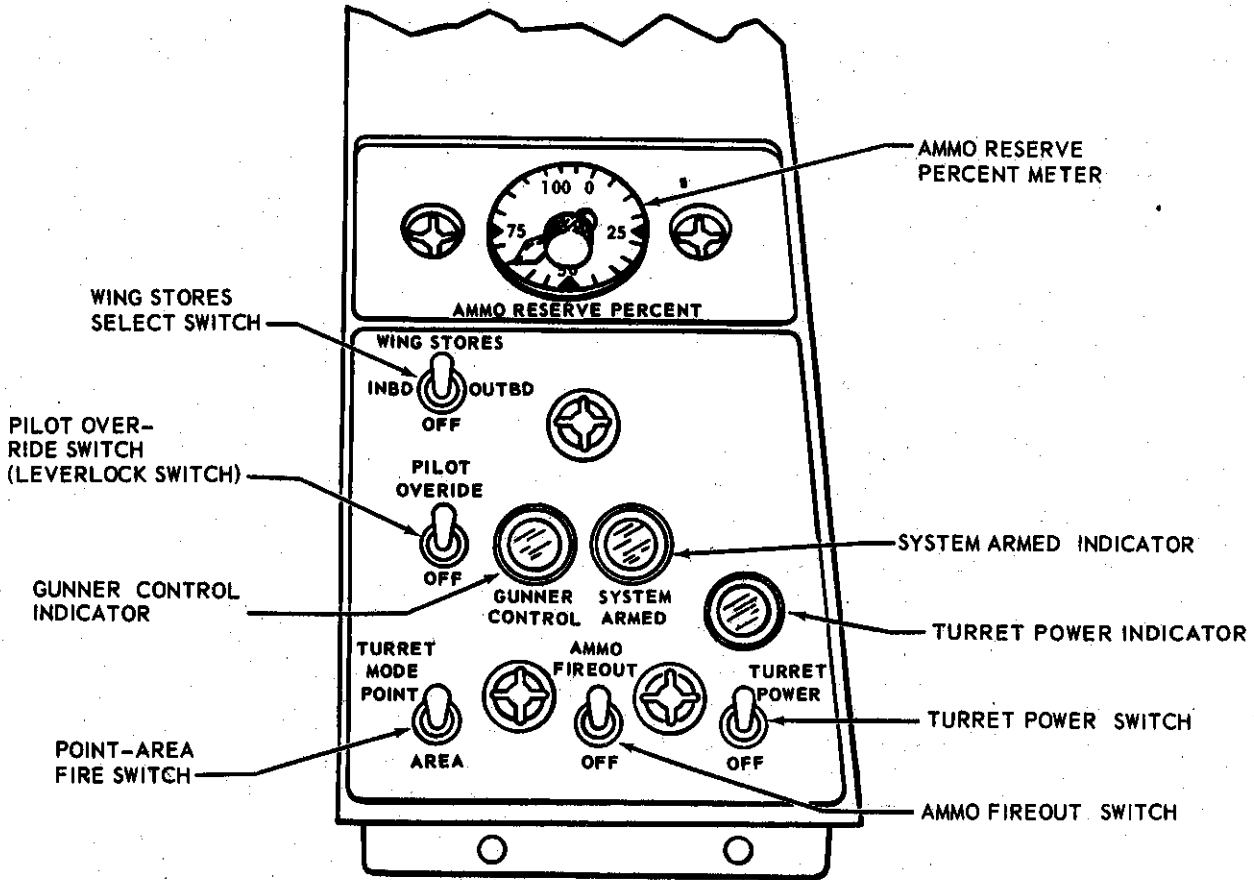

209071-5C

Figure 6-5. Gunner's armament control panel

(5) **PILOT OVERRIDE Switch.** The **PILOT OVERRIDE** switch is an emergency switch which permits the gunner to take command of the armament system when the pilot is incapacitated. Placing the switch in the fwd position energizes the pilot override relay and transfers control of the armament system and the wing pods to the gunner. In this condition, the system is fired using the triggers on the gunner's cyclic control. The system **ARMED** indicator illuminates (amber) and the **GUNNER CONTROL** indicator illuminates blue when the switch is placed in the **PILOT OVERRIDE** (fwd) position.

(6) **WING STORES Switch.** If the **PILOT OVERRIDE** switch is in the fwd position, the **WING STORES** switch may be used to select

either inboard or outboard wing pods for firing. Pod stores are fired by using the thumb button on the gunner's cyclic control.

b. **Indicators.** Following is a list of gunner's control panel indicators and their functions.

**Note**

The incandescent lamps in the indicators on the gunner's control panel may be tested by pressing the indicator lens. The lamp intensity may be varied by rotating the indicator lens.

(1) **SYSTEM ARMED Indicator.** The **SYSTEM ARMED** indicator illuminates (amber) when the pilot's **MASTER ARMED** switch is

Azimuth Position	Elevation
0°	20°
25°	23°
35°	24°
45°	25°
60°	24°
90°	19°
115°	15°

Depression ..... 50°

**Angular Velocity**

Azimuth ..... 80° per second

Elevation ..... 60° per second

**GUN (GAU-2B/A)**

Caliber ..... 7.62 mm

**Firing rate**

Low ..... 1300 rounds per  
minute (plus or minus  
400 rounds)

High ..... 4000 rounds per  
minute (plus or minus  
400 rounds)

Operation ..... fixed or flexible

Rounds ..... 8000 stored in  
ammunition boxes

**AMMUNITION**

CARTRIDGE, 7.62 MILLIMETER: NATO,  
AP, M61

CARTRIDGE, 7.62 MILLIMETER: NATO,  
ball, M59

CARTRIDGE, 7.62 MILLIMETER: NATO,  
ball, M80

CARTRIDGE, 7.62 MILLIMETER: NATO,  
tracer, M62

CARTRIDGE, 7.62 MILLIMETER DUMMY:  
NATO, M172

**Caution**

Do not use fluted case dummy cartridges.

**6-48. Normal Operating Procedures.**

**Note**

The aircraft armament circuit breakers and INVERTER switch must be in the fwd (ON) position.

**6-49. Pilot's Operating Procedures. a. Preliminary Procedure.**

(1) Place pilot's MASTER ARMED switch in the ON position.

**Caution**

Do not turn off MASTER ARM switch while the turret is being fired. This may cause damage to the gun and is a dangerous mode of operation.

(2) Place pilot's CONTROL SELECTOR switch in the PILOT position.

**b. Operating Procedures.**

(1) Place POINT-AREA FIRE switch in either the POINT or AREA position. Position of switch is dependent on intended use.

(2) To fire turret gun, depress trigger switch on cyclic control.

**Note**

Partially depressing trigger switch will fire the gun at a low rate of speed (1300 rounds per minute). Completely depressing the trigger switch will fire the gun at a high rate of speed (4000 rounds per minute).

(3) To fire wing stores, select inboard or outboard wing stores using POD SELECT switch and depress Thumb button on cyclic control.

(4) Prior to returning to base, place the CONTROL SELECTOR and MASTER ARMED switches in the OFF position.

**Note**

After landing, place the INVERTER switch and the circuit breakers in the OFF position.

**6-50. Gunner's Operating Procedures. a. Preliminary procedures.**

**Note**

The pilot's MASTER ARMED switch must be in the ON position. The pilot's CONTROL SELECTOR switch must be in the GUNNER position. Observe that SYSTEM ARMED indicator and GUNNER CONTROL indicator are illuminated.

(1) If use of the armament subsystem is anticipated, place the TURRET POWER switch in the fwd position to warm up amplifiers. Observe that TURRET POWER indicator is illuminated.

(2) Disengage sight station gimbal locks.

(3) Place sight station ground safety lever in up position.

**Caution**

Depression of the sight head will cause the barrel assembly to strike the ground resulting in damage to the turret.

**b. Operating Procedures.**

(1) Place TURRET MODE switch in either POINT or AREA position. Position of switch is dependent upon intended use.

(2) Place compensation switch in IN position if gun line correction for air speed and range is desired.

(3) Index estimated range on RANGE ADJUST knob (applicable only if compensation switch is at IN position).

(4) Depress action switches and move sight to position target in reticle image.

(5) Fire gun.

(a) For low rate of fire, depress the low rate firing triggers.

(b) For high rate of fire, depress low rate firing triggers; then depress high rate firing buttons.

**Note**

If gun ceases firing due to ammunition being expended from ammunition stowage boxes, place the FIREOUT switch to the fwd position to allow ammunition in flexible chute to be fired.

**6-51. Emergency Operating Procedure.** The emergency procedures for the automatic gun are covered in the following three paragraphs.

**6-52. Gunner's Emergency Procedures.** (Pilot disabled). a. Place PILOT OVERRIDE switch in fwd position.

b. To fire gun, depress trigger switch on cyclic control.

**Note**

Partially depressing trigger switch will fire gun at a low rate of speed (1800 rounds per minute). Completely depressing the trigger switch will fire the gun at a high rate of speed (4000 rounds per minute).

c. To fire wing stores, select inboard or outboard wing stores using WING STORES switch and depress thumb button on cyclic control.

d. Prior to returning to base, place PILOT OVERRIDE switch in OFF position.

**6-53. Pilot's Emergency Procedure (Runaway Gun).** In the event of a runaway gun, place MASTER ARMED switch in the OFF position.

**6-54. Pilot's Emergency Procedure (No. 2 Hydraulic System Failure).** Should a hydraulic failure occur, gun will remain in azimuth when failure occurred but will return to zero (stow position) elevation or higher. Gunner should visually check azimuth position of gun and advise pilot, as gun will not be cleared and necessary precautions must be taken.

**Caution**

In the event of the loss of one hydraulic system, the turret shall not be operated.

**6-55. Operation — Preflight Check.** Perform the following operations.

**a. EXTERIOR CHECKS.**

(1) 7.62mm automatic gun — Secure.

(2) Ammunition box assemblies — Loaded.

(3) Electrical connectors — Connected.

(4) Hydraulic connectors — Connected.

(5) Flexible shaft and ammunition chute — Connected.

b. INTERIOR — PILOT.

- (1) Clear area in front of helicopter.
- (2) MASTER ARM switch — OFF.

c. INTERIOR — GUNNER.

- (1) TURRET POWER switch — OFF.
- (2) WING STORES switch — OFF.
- (3) PILOT OVERRIDE switch — OFF.
- (4) AMMO FIREOUT switch — OFF.
- (5) AMMO RESERVE PERCENT meter — 100.

- (6) Indicator lights — Illuminate.
- (7) Sighting Station — Stowed.
- (8) Ground Safety Lever — Down.

**6-56. Inflight Operation.** To fire the TAT-102A turret system perform the following operations.

a. PILOT. (Pilot to fire gun).

- (1) MASTER ARM switch — ON.
- (2) TURRET CONT switch — PILOT.
- (3) TURRET MODE switch — Select.
- (4) Cyclic Turret switch — Depress.

b. GUNNER. (Gunner to fire gun).

- (1) TURRET CONT switch (Pilot's) — GUNNER.
- (2) MASTER ARM switch (Pilot's) — ON.
- (3) TURRET POWER switch — fwd (ON).
- (4) Sighting Station Gimbal Locks — Disengage.

(5) Sight Station Ground Safety Lever — Up.

(6) TURRET MODE switch — Select.

(7) COMPENSATION switch — Select.

(8) Range Adjust Knob — Adjust.

(9) Action switch — Depress as required.

(10) Low Rate Firing Trigger — Depress as required.

(11) High Rate Firing Button — Depress as required.

**6-57. Inflight — Turret Securing.** Perform the following prior to returning to operational base.

a. GUNNER.

- (1) Action switch — Momentarily depress.
- (2) Low Rate Firing Trigger — Momentarily depress.
- (3) Sight Station Ground Safety Lever — Down.
- (4) Sight Station Gimbal Locks — Engaged.

(5) TURRET POWER switch — OFF.

b. PILOT.

(1) TURRET CONT switch — OFF.

**Caution**

Do not turn off MASTER ARM switch while the turret is being fired. This may cause damage to the gun and is a dangerous mode of operation.

(2) MASTER ARM switch — OFF.

**6-58. Before Leaving Helicopter.** Perform the following operations.

a. PILOT.

(1) MASTER ARM switch — OFF.



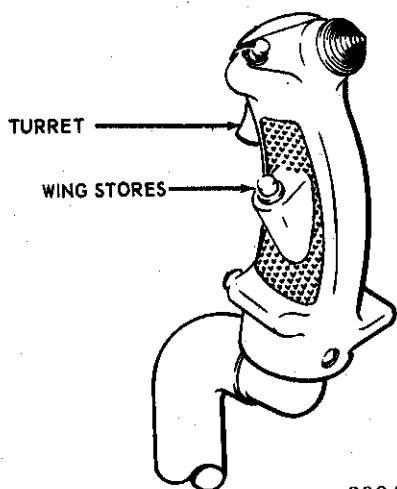

209478-8B

Helicopters S/N 66-15249 through 66-15257

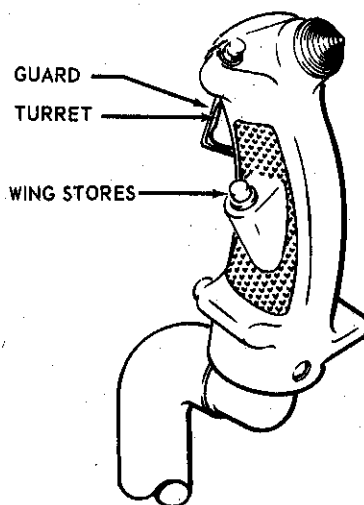

209478-6C

Helicopters S/N 66-15258 and subsequent

**Figure 6-10. Cyclic stick armament switches**

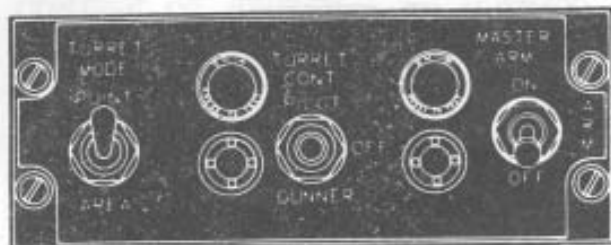

Helicopters serial number 66-15249 through 66-25257  
209075-4

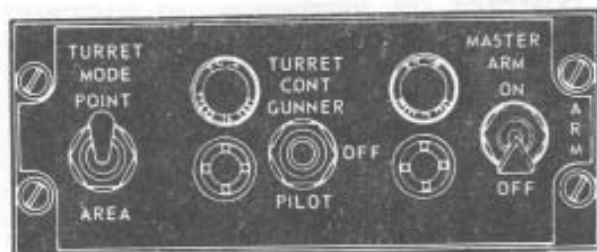

Helicopters serial number 66-15258 and subsequent  
209075-4A

Figure 6-11. Pilot's turret control panel

(2) TURRET CONT switch — OFF.

b. GUNNER.

- (1) TURRET POWER switch — OFF.
- (2) WING STORES switch — OFF.
- (3) PILOT OVERRIDE switch — OFF.
- (4) AMMO FIREOUT switch — OFF.
- (5) Sighting Station — Stowed.
- (6) Ground Safety Lever — Down.

6-59. Deleted.

**6-60. Pilot Sighting Station.** The pilot is provided with a fixed illuminated reticle sight for firing the TAT-102A turret in the stowed position and podded guns and rockets on the wing stores.

**6-61. Cyclic Stick Armament Switches.** The cyclic stick provides two armament switches: Wing Stores and Turret (see figure 6-10).

**6-62. Wing Stores.** The lower thumb button on the cyclic stick is used to fire the wing stores. After presetting the wing stores selection switch, the wing stores may be fired. An interrupter circuit is installed to interrupt the turret firing when the thumb button is depressed.

**6-63. Turret.** The turret trigger switch will fire the turret mounted gun. The pilot may fire the turret, at his discretion, when the turret is in the stowed position. When the gunner has the turret in a slew mode, the pilot cannot fire the turreted gun. The pilot may override the gunner by actuating the TURRET CONT switch to the PILOT position. When this switch is actuated, the turret will return to stow and the pilot will have control. The gun may then only be fired from the pilot and gunner cyclic triggers. The turret trigger has a guard that must be moved forward to provide access to actuate the trigger switch. This guard prevents the inadvertent firing of the turreted gun.

**6-64. Pilot's Turret Control Panel.** The pilot's turret control panel (see figure 6-11) is located at the forward area of the pilot's station. The control panel contains the following: TURRET MODE switch, indicator light, TURRET CONT switch, indicator light and MASTER ARM switch. The functions of the switches and indicator lights are as follows:

CONTROL OR SWITCH  
INDICATOR POSITION      FUNCTION

CONTROL OR SWITCH  
INDICATOR POSITION      FUNCTION

<b>TURRET MODE (Switch)</b>		This is a two position switch: <b>POINT — AREA</b>
	<b>POINT</b>	With the switch in this position, the gun is slaved to the sight.
	<b>AREA</b>	With the switch in this position, the gun oscillates laterally to give a scattered lateral pattern on the selected area. Switch will override gunner's selection if pilot's <b>TURRET CONT</b> switch is in the <b>PILOT</b> position.
<b>TURRET CONT (Light)</b>		This light illuminates (blue) when the <b>TURRET CONT</b> switch is in the <b>PILOT'S</b> position. Authority for this light is <b>TURRET CONT</b> switch.
		This is a three position switch. <b>PILOT-OFF-GUNNER.</b>
<b>TURRET CONT (Switch)</b>	<b>PILOT</b>	With the switch in this position the turret is hot and the pilot has control.
	<b>OFF</b>	Turret control circuit is deactivated
	<b>GUNNER</b>	With the switch in this position the turret is hot and the gunner has control.

<b>MASTER ARM (Light)</b>		This light illuminates (amber) when the <b>MASTER ARM</b> switch is in the <b>ON</b> position, and the armament systems are in standby.
		This is a two position (guarded) switch: <b>ON-OFF.</b>
<b>MASTER ARM (Switch)</b>	<b>ON</b>	This position arms the basic weapons systems including wing stores, turret, and smoke grenade dispenser. These weapons are, however, not hot until the following three switches are energized, <b>TURRET CONT</b> , <b>WG STS ARM</b> and <b>SMK GRENADE.</b>
	<b>OFF</b>	This position de-energizes the armament circuits.

**6-65. Pilot's Wing Stores Control Panel (Helicopters serial number 66-15249 through 66-15257).** The pilot's wing stores control panel (figure 6-12) is located in the forward area of the pilot's station. The control panel contains the following: Armed light, **WG STS** Jettison switch, **RKT PR SEL** switch, **WG STS Arm** switch and **SMK Grenade** switch. The function of the switches and indicator lights are as follows:

CONTROL OR SWITCH INDICATOR   POSITION   FUNCTION

CONTROL OR SWITCH INDICATOR   POSITION   FUNCTION

ARMED  
(Light)

This indicator light will illuminate (amber) when the Wing Stores Arm switch is in the OUTBD or INBD position.

fired in pairs according to the preselected position of the switch.

WG ST  
JETTISON  
(Switch)

WG ST  
ARM  
(Switch)

This is an arm toggle switch with three positions as follows: OUTBD, OFF and INBD.

OUTBD

This is a three position Wing Stores jettison lever lock switch with the following positions: OUTBD, OFF and INBD.

OUTBD

This position arms the outboard wing stores.

OUTBD

This position jettisons the outboard wing stores.

OFF

This position deactivates the wing stores arm circuit.

OFF

This position deactivates the wing stores jettison system circuit.

INBD

This position arms the inboard wing stores.

INBD

This position jettisons the inboard wing stores.

SMK  
GRENADE  
(Switch)

This is a momentary, spring loaded center position, Fire No. 1, OFF and Fire No. 2.

RKT PR  
SEL  
(Switch)

FIRE  
NO. 1

This position drops colored smoke grenade that is controlled by the No. 1 circuit.

1

This position energizes the wing stores circuit to fire one pair of rockets.

OFF

This position deactivates the smoke grenade circuit.

2, 4, 7  
and 19

With selector in these positions the quantity of rockets are

FIRE  
NO. 2

This position drops colored smoke grenade that is controlled by the No. 2 circuit.

**6-65A. Pilot's Wing Stores Control Panel.** (Helicopters serial number 66-15258 and subsequent.) The pilot's wing stores control panel (figure 6-12A) is located in the lower center area of the instrument panel. The control panel contains the following: Armed light, WG ST JETTISON SELECT switch, RKT PR SEL switch, WG ST Arm switch and SMK GRENADE switch. The function of the switches and indicator lights are as follows:

CONTROL OR SWITCH  
INDICATOR POSITION FUNCTION

2, 4, 7  
and 19 With selector in these positions the quantity of rockets are fired in pairs according to the preselected position of the switch.

CONTROL OR SWITCH  
INDICATOR POSITION FUNCTION

**ARMED**  
(light) This indicator light will illuminate (amber) when the Wing Stores Arm switch is in the OUTBD or INBD position.

**WG ST JETTISON SELECT**  
(Switch) This is a three position Wing Stores Jettison Select lever lock switch with the following positions: OUTBD, BOTH and INBD

**OUTBD** This position disables the pilots inboard wing stores jettison circuit so it can not be fired.

**BOTH** This position allows both inboard and outboard wing stores to be salvo jettisoned.

**INBD** This position disables the pilot's outboard wing stores jettison circuit so it can not be fired.

**RKT PR SEL**  
(Switch) This is a rotary rocket pair selector switch with five positions as follows: 1, 2, 4, 7 and 19.

**1** This position energizes the wing stores circuit to fire one pair of rockets.

**WG ST ARM**  
(Switch) This is an arm toggle switch with three positions as follows: OUTBD, OFF and INBD.

**OUTBD** This position arms the outboard wing stores.

**OFF** This position deactivates the wing stores arm circuit.

**INBD** This position arms the inboard wing stores.

**SMK GRENADE**  
(Switch) This is a momentary, spring loaded center position, Fire No. 1, OFF and Fire No. 2.

**FIRE NO. 1** This position drops colored smoke grenade that is controlled by the No. 1 circuit.

**OFF** This position deactivates the smoke grenade circuit.

**FIRE NO. 2** This position drops colored smoke grenade that is controlled by the No. 2 circuit.

**6-66. External Stores.** Four attachment points are provided, two under each wing panel. These are located 42.5 inches and 60.0 inches from the center line of the helicopter.

**6-67. Pylons.** The pylon assemblies include special 14 inch external store racks, sway braces and standard electrical connections for the external stores. The entire assembly is enclosed in a fairing that matches the lower contour of the wing. The ejector rack of each pylon is equipped with an electrically operated

ballistic emergency jettison device. The jettison system consists of a breech block that utilizes two cartridges. Activation of a jettison switch (pilot's or gunner's) fires the cartridges and gas pressure actuates a piston, opening the hooks and separates the stores simultaneously. The breech block holds two cartridges and each cartridge is provided with a firing circuit. However, if one cartridge should fail to fire, the fired cartridge will fire the unignited cartridge through interconnecting ports. Gas pressure from the breech also actuates a slave piston that contacts a striker block attached to the bellcrank. The piston force overcomes the existing closing moment at the link load and opens the hook (releases pod). The pilot has a jettison select switch located in the pilot's wing stores control panel and a jettison switch on the instrument panel. The gunner has a jettison switch located on the left side of his instrument panel.

**6-68. Pods.** The external stores for the helicopter are listed in the following paragraphs.

**6-69. Rockets.** The 2.75 inch folding fin aerial rockets (FFAR) are carried in either a 19 tube rocket pod or a 7 tube rocket pod. The wing stores will provide for a maximum of four 19 tube pods — 76 rockets.

**6-70. Guns.** Provisions are included for the XM-18 automatic gun pod at each inboard station. This pod has the 7.62 mm automatic gun installed with a self-contained electric power supply. Each pod carries 1500 rounds and is fired at a 4000 rounds per minute rate. These fixed guns are aimed by flying the helicopter directly at the target.

**6-71. Rocket Launcher — XM-157.** The XM-157 launcher is reusable. It fires seven 2.75 inch FFAR's. The wings have two hard point locations on each wing which provides locations for four XM-157 launchers. See figure 6-13 for rocket firing order.

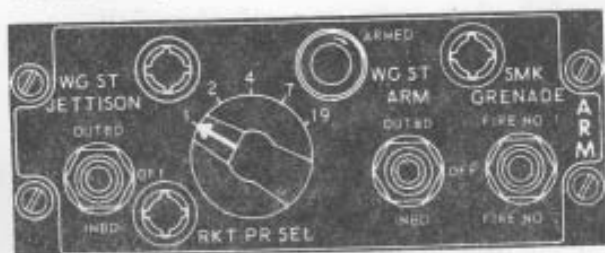

Helicopters serial number 66-15249 through 66-15258  
209075-3A

Figure 6-12. Pilot's wing stores control panel

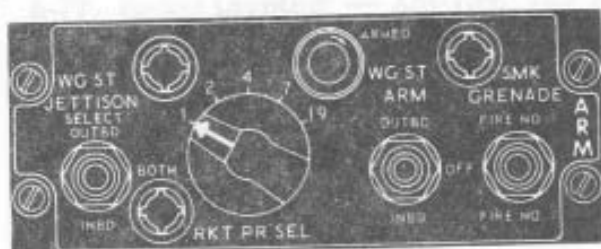

209075-3B

Figure 6-12A. Pilot's wing stores control panel

**6-72. Rocket Launcher — Tabulated Data.**

Weight per Launcher (Empty)	51.5 pounds
Weight per Launcher (Loaded)	202.5 pounds
Capacity (2.75 inch FFAR)	7 rockets
Cross Section	9.8 in. Diam.
Length	49.87 inch

**6-73. Controls.** The pilot and gunner are provided with controls for operation of the wing stores armament. The primary controls are located forward area of the pilot's compartment. The gunner's armament control panel is located in his right console. The gunner's panel has a POD SELECT switch and a PILOT OVERRIDE switch. The pilot has a MASTER ARM switch, POD SELECT switch and ROCKET PAIR SELECT switch.

**6-74. Operation — Preflight Check.** Perform the following operations:

- a. INTERIOR — GUNNER.
  - (1) Clear area in front of helicopter.
  - (2) WING STORES switch — OFF.

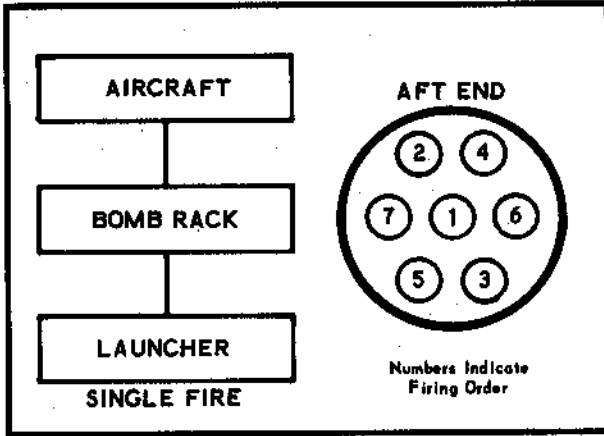

209071-1

**Figure 6-13. XM-157 rocket launcher firing order**

(3) PILOT OVERRIDE switch — OFF.  
(OFF).

b. INTERIOR — PILOT.

(1) Clear area in front of helicopter.

(2) WG ST JETTISON switch — OFF  
(Helicopters serial number 66-15249 through  
66-15257).

(3) WG ST JETTISON SELECT switch —  
BOTH (Helicopters serial number 66-15258 and  
subsequent).

(4) RKT PR SEL switch — As desired.

(5) WG ST ARM switch — OFF.

(6) MASTER ARM switch — OFF.

c. EXTERIOR.

(1) Rockets loaded and detents secure.

(2) Ejector rack safety pin — Removed  
(each rack).

(3) Check that arming procedures have  
been completed and electrical connection be-  
tween helicopter and launcher is connected.

**6-75. Inflight Operation.** Perform following  
operations.

- a. WING STORES circuit breaker — IN.
- b. MASTER ARM switch — ON.
- c. RKT PR SEL switch — As desired.
- d. WG STS ARM switch — OUTBD or INBD.
- e. Align fixed sight on target.
- f. Depress cyclic firing thumb button.

**Warning**

Failure to fire may result if the firing  
switch is not closed for at least one-  
tenth of a second.

**6-76. Before Leaving Helicopter.** Perform  
following operations.

- a. WG ST ARM switch — OFF.
- b. MASTER ARM switch — OFF.
- c. WING STORES circuit breakers — OUT.

**6-77. Rocket Launcher — XM-159.** The 159  
launcher is reusable. It fires nineteen 2.75 inch  
FFAR's. The wings have two hard point loca-  
tions on each wing which provides for four  
XM-159 launchers. See figure 6-14 for rocket  
firing order. When both the XM-157 and XM-  
159 launchers are installed the XM-159 launch-  
ers shall be on the inboard hard points.

**6-78. Rocket Launcher — Tabulated Data.**

Weight per Launcher (Empty)	102 pounds
Weight per Launcher (Loaded — 6 lb. warhead)	512 pounds
Capacity (2.75 inch FFAR)	19 rockets
Cross Section	15.5 inch diam.
Length	49.87 inches

**6-79. Operation — Preflight Check.** Refer to para-  
graph 6-74.

**6-80. Inflight Operation.** Refer to paragraph  
6-75.

**6-81. Before Leaving Helicopter.** Refer to para-  
graph 6-76.

**6-82. Gun Pod — XM-18.** The XM-18 gun  
pod houses a 7.62 mm automatic gun. The gun  
pod is carried on the inboard hard points of

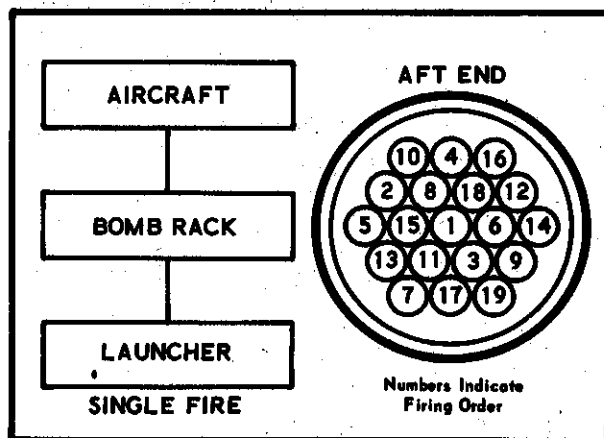

209071-2

Figure 6-14. XM-159 rocket launcher firing order



each wing. The gun pod carries its own electrical system and space for 1500 rounds of 7.62 mm ammunition. The pod is a self-contained unit with a battery recharging system.

**6-83. Gun Pod — Tabulated Data.**

Weight Empty (each pod)	245 pounds
Weight Loaded (each pod)	378 pounds
Length	85 inches
Diameter	12 inches
Maximum Burst Length	Full Complement
Capacity	1500 rounds
Gun and Feed System	Electric

**6-84. Operation — Preflight Check.** Perform the following operations:

a. INTERIOR — GUNNER.

- (1) Clear area in front of helicopter.
- (2) POD SELECT switch — OFF.
- (3) PILOT OVERRIDE switch — OFF.

b. INTERIOR — PILOT.

- (1) Clear area in front of helicopter.
- (2) WGS ST JETTISON switch — OFF (Helicopters serial number 66-15249 through 66-15257).
- (3) WGS ST JETTISON SELECT switch — BOTH (Helicopters serial number 66-15258 and subsequent).

- (4) WGS ST ARM switch — OFF.
- (5) WING STORES circuit breakers — IN.
- (6) MASTER ARM switch — OFF.

c. EXTERIOR.

- (1) Check pod for general condition and security.
- (2) Check for correct indicator reading (quantity of rounds).
- (3) Ejector rack safety pin — Removed (each rack).

**6-85. Inflight Operation.** Perform following operations:

- a. WING STORES circuit breakers — IN.
- b. MASTER ARM switch — ON.
- c. WG ST ARM switch — INBD.
- d. ARMED light — Illuminated.
- e. Align fixed sight on target.
- f. Depress cyclic firing thumb button.

**6-86. Before Leaving Helicopter.** Perform following operations.

- a. WG ST ARM switch — OFF.
- b. MASTER ARM switch — OFF.
- c. WING STORES circuit breakers — OUT.

**6-87. Operation.** The weapon system of the helicopter can be used in the following modes of operation.

**Rocket and Flex Turret** This mode of operation allows the gunner to select a separate target while the pilot is firing the rockets. The pilot uses his fixed sight and estimates the range. The gunner is able to fire the automatic gun at both 1300 and 4000 rounds per minute. The rocket fire switch will momentarily cut off the gun fire to prevent the bullets from hitting the rockets.

**Turret Flex** This mode of operation allows the gunner full control of turret and gun.

**Turret Stowed** The chin turret is stowed in both azimuth and elevation to a predetermined bore sight reference. If the gunner is flying the helicopter he can fire the gun from this fixed position at both 1300 and 4000 rounds per minute. The gunner must use a reference of some type (i.e. grease pencil mark on windshield) and must correct fire by tracers

13

# LANDING DISTANCE — FEET

## POWER ON

13

Model(s): AH-1G  
Data as of: JULY 1966  
DATA BASIS: ESTIMATED

ENGINE SPEED 6600 RPM  
MILITARY RATED POWER

Engine(s): Lycoming T53-L-13  
Fuel Grade: JP-4  
Fuel Density: 6.5 LB/GAL.

GROSS WEIGHT	PRESS. ALT	-25° C (-13° F)		-5° C (+23° F)		+15° C (+59° F)		+35° C (+95° F)		+55° C (+131° F)					
		BEST APPROACH TAS KNOTS	DIST AFTER CLEAR 50 FT.	BEST APPROACH TAS KNOTS	DIST AFTER CLEAR 50 FT.	BEST APPROACH TAS KNOTS	DIST AFTER CLEAR 50 FT.	BEST APPROACH TAS KNOTS	DIST AFTER CLEAR 50 FT.	BEST APPROACH TAS KNOTS	DIST AFTER CLEAR 50 FT.				
6000	0	0	0	0	0	0	0	0	0	0	0				
	2000	0	0	0	0	0	0	0	0	0	0				
	4000	0	0	0	0	0	0	0	0	0	0				
	6000	0	0	0	0	0	0	0	0	0	3	1			
	8000	0	0	0	0	0	0	0	0	0	14	25			
	10000	0	0	0	0	0	0	0	0	0	23	65			
	12000	0	0	0	0	0	0	18	32	34	165				
	14000	0	0	0	0	4	1	29	102	45	270				
	16000	0	0	0	0	24	70	42	240						
	18000	0	0	19	44	39	178								
6000	20000	17	34												
6500	0	0	0	0	0	0	0	0	0	0	0				
	2000	0	0	0	0	0	0	0	0	0	0				
	4000	0	0	0	0	0	0	0	0	0	0				
	6000	0	0	0	0	0	0	0	0	14	24				
	8000	0	0	0	0	0	0	0	0	23	69				
	10000	0	0	0	0	0	0	18	34	34	178				
	12000	0	0	0	0	3	1	39	110	45	291				
	14000	0	0	0	0	24	75	42	256						
	16000	0	0	19	47	38	191								
6500	18000	17	36												

1. No wind.
- REMARKS: 2. Configuration: Basic, Scout or Hog
3. Distance to clear 50 feet is given as zero when the helicopter can hover OGE. When helicopter cannot hover OGE, MINIMUM possible distance and speeds to clear a 50 foot obstacle are given. These are minimum values and require good pilot technique. For a normal landing, the distances and speeds given for power off landings will provide safer operation within the height-velocity diagram for the helicopter.
4. Landing distances includes a 30 foot estimated skid distance where it is not possible to hover at a two foot skid height.
5. Speed over the 50 foot obstacle is in true airspeed (TAS) because values of indicated airspeed (IAS) below 20 knots may not be reliable.
6. Landing distances are not shown above 20,000 feet or cruise ceiling.

Figure 14-16. Landing distance — Power ON (Sheet 1 of 8)

## TABLE OF CONTENTS

CHAPTER & SECTION		PAGE
Chapter 1	INTRODUCTION	
Section I	Scope	1-1
Section II	General Information	1-2
Chapter 2	DESCRIPTION	
Section I	Scope	2-1
Section II	Aircraft Systems and Controls Description	2-1
Chapter 3	NORMAL PROCEDURES	
Section I	Scope	3-1
Section II	Flight Procedures	3-1
Chapter 4	EMERGENCY PROCEDURES	
Section I	Scope	4-1
Section II	Engine	4-2
Section III	Tail Rotor	4-4
Section IV	Fire	4-6
Section V	Fuel System	4-7
Section VI	Electrical System	4-8
Section VII	Hydraulic System	4-8
Section VIII	Landing and Ditching	4-9
Section IX	Flight Controls	4-10
Section X	Bail Out	4-11
Section XI	Emergency Jettisoning (wing stores)	4-11
Chapter 5	AVIONICS	
Section I	General	5-1
Section II	Description and Data	5-2
Section III	Operating Controls	5-6
Section IV	Types of Operating Facilities (Not Applicable)	
Section V	Preliminary Starting Procedures (Not Applicable)	
Section VI	Operating Procedures	5-12
Section VII	Inspection (Not Applicable)	
Section VIII	Operation of Electronic Equipment in Conjunction With Other Items (Not Applicable)	
Chapter 6	AUXILIARY EQUIPMENT	
Section I	Scope	6-1
Section II	Heating and Ventilation	6-1
Section III	Anti-Icing, Deicing and Defrosting Systems	6-3
Section IV	Lighting Equipment	6-4
Section V	Oxygen System (Not Applicable)	
Section VI	Auxiliary Power Unit (Not Applicable)	
Section VII	Armament Systems	6-6
Section VIII	Photographic Equipment (Not Applicable)	
Section IX	Aerial Delivery Equipment (Not Applicable)	
Section X	Miscellaneous Equipment	6-26
Chapter 7	OPERATING LIMITATIONS	
Section I	Scope	7-1
Section II	Limitations	7-1

CHAPTER & SECTION		PAGE
Chapter 8	FLIGHT CHARACTERISTICS	
Section I	Scope	8-1
Section II	General Flight Characteristics	8-1
Section III	Control Characteristics	8-2
Chapter 9	SYSTEMS OPERATION	
Section I	Scope	9-1
Section II	Systems	9-1
Chapter 10	WEATHER OPERATIONS	
Section I	Scope	10-1
Section II	Instrument Flight Procedures	10-1
Section III	Cold Weather Operation	10-6
Section IV	Desert and Hot Weather Operation	10-11
Section V	Turbulence and Thunderstorm Operation	10-11
Chapter 11	CREW DUTIES (Not Applicable)	
Chapter 12	WEIGHT AND BALANCE COMPUTATIONS	
Section I	Scope	12-1
Section II	Introduction	12-1
Section III	Definitions	12-1
Section IV	Chart Explanations	12-2
Section V	Weight and Balance Clearance Form F	12-12
Chapter 18	AIRCRAFT LOADING	
Section I	Scope	18-1
Section II	Introduction	18-1
Section III	Preparations of Aircraft and Personnel Cargo for Loading and Unloading (Not applicable)	
Section IV	General Information for Loading Security and Unloading Cargo (Not applicable)	
Section V	Loading and Unloading of other than General Cargo (Not applicable)	
Chapter 14	PERFORMANCE DATA	
Section I	Scope	14-1
Section II	Instruction For Chart Use	14-1
Appendix I	REFERENCE	AI-I
Appendix II	CROSS REFERENCE TO MAX	AII-I
Appendix III	AIRCRAFT INVENTORY MASTER GUIDE	AIII-I
Appendix IV	OPERATOR'S CHECKLIST	AIV-I
Index	ALPHABETICAL INDEX	Index 1

CHANGE }  
No. 1 }

HEADQUARTERS  
DEPARTMENT OF THE ARMY  
WASHINGTON, D. C. 24 August, 1967

**Operator's Manual**  
**ARMY MODEL AH-1G HELICOPTER**

TM 55-1520-221-10, 10 April 1967, is changed as follows:

1. Remove and insert pages as indicated below.

	Remove pages	Insert pages
Table of Contents	i and ii	i and ii
Chapter 1 Section I	1-1 and 1-2	1-1 and 1-2
Chapter 2 Sections I, II	2-1 thru 2-4	2-1 thru 2-4
	2-7 thru 2-10	2-7 thru 2-10
		2-12A
	2-13 and 2-14	2-13 and 2-14
		2-14A
	2-15 thru 2-22	2-15 thru 2-22
	2-25 thru 2-34	2-25 thru 2-34
Chapter 3 Sections I, II	3-1 thru 3-8	3-1 thru 3-8
Chapter 4 Section I	4-1 thru 4-4	4-1 thru 4-4
		4-4A
Section VII, VIII, XII	4-9 thru 4-12	4-9 thru 4-12
Chapter 5 Section I, VI	5-1 thru 5-8	5-1 thru 5-8
	5-15 and 5-16	5-15 and 5-16
Chapter 6 Section IV, V, VII	6-5 thru 6-16	6-5 thru 6-16
		6-16A
	6-17 thru 6-20	6-17 thru 6-20
	6-23 thru 6-26	6-23 thru 6-26
Chapter 7 Section II	7-3 thru 7-6	7-3 thru 7-6
Chapter 8 Section I, II, III	8-1 thru 8-4	8-1 thru 8-4
Chapter 9 Section II	9-3 thru 9-6	9-3 thru 9-6
Chapter 10 Section III	10-7 and 10-8	10-7 and 10-8
Chapter 12 Section III	12-3 and 12-4	12-3 and 12-4
	12-7 and 12-8	12-7 and 12-8
		12-8A thru 12-8D
	12-9 and 12-10	12-9 and 12-10
Section V	12-13 and 12-14	12-13 and 12-14
Chapter 14 Section I, II	14-1 and 14-2	14-1 and 14-2
		14-6A
	14-9 and 14-10	14-9 and 14-10
	14-11 thru 14-14	
	14-15 thru 14-18	14-15 thru 14-18
	14-19 thru 14-22	
	14-25 and 14-26	14-25 and 14-26
	14-27 thru 14-34	
	14-39 and 14-40	14-39 and 14-40
	14-41 thru 14-44	

	Remove pages	Insert pages
Chapter 14 Section I, II (Cont'd).	14-47 and 14-48	14-47 and 14-48
	14-49 thru 14-52	
	14-62 thru 14-70	
		14-61
	14-80 thru 14-88	
	14-98 thru 14-106	
	14-109 and 14-110	14-97
	14-111 thru 14-114	14-109 and 14-110
	14-118 thru 14-119	
		14-117
	14-121 thru 14-127	14-121 thru 14-123
	14-132 thru 14-136	14-128
Index	1 thru 6	14-131
		1 thru 6

2. Retain this sheet in front of manual for reference purposes.

By Order of the Secretary of the Army:

Official:

**KENNETH G. WICKHAM,**  
*Major General, United States Army,*  
*The Adjutant General.*

**HAROLD K. JOHNSON,**  
*General, United States Army,*  
*Chief of Staff.*

**DISTRIBUTION:**

To be distributed in accordance with DA Form 12-31 requirements for Operator and Crew Maintenance Instructions for AH-1G aircraft.

## TABLE OF CONTENTS

CHAPTER & SECTION		PAGE
Chapter 1	INTRODUCTION	
Section I	Scope	1-1
Section II	General Information	1-2
Chapter 2	DESCRIPTION	
Section I	Scope	2-1
Section II	Aircraft Systems and Controls Description	2-1
Chapter 3	NORMAL PROCEDURES	
Section I	Scope	3-1
Section II	Flight Procedures	3-1
Chapter 4	EMERGENCY PROCEDURES	
Section I	Scope	4-1
Section II	Engine	4-2
Section III	Tail Rotor	4-4
Section IV	Fire	4-6
Section V	Fuel System	4-7
Section VI	Electrical System	4-8
Section VII	Hydraulic System	4-8
Section VIII	Landing and Ditching	4-9
Section IX	Flight Controls	4-10
Section X	Bail Out	4-11
Section XI	Emergency Jettisoning (wing stores)	4-11
Section XII	SAS System	4-11
Chapter 5	AVIONICS	
Section I	General	5-1
Section II	Description and Data	5-2
Section III	Operating Controls	5-6
Section IV	Types of Operating Facilities (Not Applicable)	
Section V	Preliminary Starting Procedures (Not Applicable)	
Section VI	Operating Procedures	5-12
Section VII	Inspection (Not Applicable)	
Section VIII	Operation of Electronic Equipment in Conjunction With Other Items (Not Applicable)	
Chapter 6	AUXILIARY EQUIPMENT	
Section I	Scope	6-1
Section II	Heating and Ventilation	6-1
Section III	Anti-Icing, Deicing and Defrosting Systems	6-3
Section IV	Lighting Equipment	6-4
Section V	Oxygen System (Not Applicable)	
Section VI	Auxiliary Power Unit (Not Applicable)	
Section VII	Armament Systems	6-6
Section VIII	Photographic Equipment (Not Applicable)	
Section IX	Aerial Delivery Equipment (Not Applicable)	
Section X	Miscellaneous Equipment	6-26
Chapter 7	OPERATING LIMITATIONS	
Section I	Scope	7-1
Section II	Limitations	7-1

CHAPTER & SECTION		PAGE
Chapter 8	<b>FLIGHT CHARACTERISTICS</b>	
Section I	Scope	8-1
Section II	General Flight Characteristics	8-1
Section III	Control Characteristics	8-2
Chapter 9	<b>SYSTEMS OPERATION</b>	
Section I	Scope	9-1
Section II	Systems	9-1
Chapter 10	<b>WEATHER OPERATIONS</b>	
Section I	Scope	10-1
Section II	Instrument Flight Procedures	10-1
Section III	Cold Weather Operation	10-6
Section IV	Desert and Hot Weather Operation	10-11
Section V	Turbulence and Thunderstorm Operation	10-11
Chapter 11	<b>CREW DUTIES</b> (Not Applicable)	
Chapter 12	<b>WEIGHT AND BALANCE COMPUTATIONS</b>	
Section I	Scope	12-1
Section II	Introduction	12-1
Section III	Definitions	12-1
Section IV	Chart Explanations	12-2
Section V	Weight and Balance Clearance Form F	12-12
Chapter 13	<b>AIRCRAFT LOADING</b>	
Section I	Scope	13-1
Section II	Introduction	13-1
Section III	Preparations of Aircraft and Personnel Cargo for Loading and Unloading (Not applicable)	
Section IV	General Information for Loading Security and Unloading Cargo (Not applicable)	
Section V	Loading and Unloading of other than General Cargo (Not applicable)	
Chapter 14	<b>PERFORMANCE DATA</b>	
Section I	Scope	14-1
Section II	Instruction For Chart Use	14-1
Appendix I	<b>REFERENCE</b>	AI-I
Appendix II	<b>CROSS REFERENCE TO MAX</b>	AII-I
Appendix III	<b>AIRCRAFT INVENTORY MASTER GUIDE</b>	AIII-I
Appendix IV	<b>OPERATOR'S CHECKLIST</b>	AIV-I
Index	<b>ALPHABETICAL INDEX</b>	Index 1



## CHAPTER I

## INTRODUCTION

## Section I — Scope

**IMPORTANT**

In order to obtain complete information and derive maximum benefits from this manual, it is necessary to read this chapter carefully and thoroughly.

**1-1. Purpose.** This operator's manual is issued expressly for operators and is an official document for Army Model AH-1G helicopters. Serial numbers of applicable helicopters are 66-15247 through 66-15357.

**1-2.** The purpose of this manual is to supply you with the latest information and performance data derived from flight test programs and operational experience. The study and use of this manual will enable you to perform the assigned duties and mission with maximum efficiency and safety.

**1-3.** Your ability and experience are recognized. Therefore, it is not the function of this manual to teach a pilot how to fly. Basic flight principles and elementary instructions are not included, the contents of this manual will provide you with a general knowledge of Army Model AH-1G helicopter, its flight characteristics and specific normal and emergency operating procedures.

**1-4.** Reports necessary to comply with the Army Aviation Safety Program are described in detail in AR 385-40.

**1-5. Appendix I.** This appendix contains a listing of all references that are applicable and available to the operator. The list includes official publications directly applicable to the Operator's Manual. All references called out in the text are reflected in this appendix.

**1-6. Appendix II.** This appendix consists of a page titled Appendix II, Maintenance Allocation Chart, and references the Maintenance Allocation Chart contained in TM 55-1520-221-20.

**1-7. Appendix III.** This appendix consists of a page titled Appendix III, Aircraft Inventory Master Guide, and references Appendix III, TM 55-1520-221-20.

**1-8. Appendix IV.** This appendix consists of a page titled Appendix IV, Operator's and Crew-member's Checklist. The checklist contains normal and emergency procedures to be performed by the pilot (and/or gunner). The applicable check list is not presented in this manual but is printed as a separate publication.

**1-9. Index.** The index lists, in alphabetical order, every important subject under the topic which may be of significance to the operator. This listing is not a repetition of paragraph titles, but an extensive listing of subjects which will aid the operator in his use of this manual.

**Note**

Do not destroy any page in this manual unless the data contained thereon has been replaced, superseded or included in the manual by change or revision.

Section II — General

**1-10. Scope.** The contents of this manual are arranged under Chapters and Sections as indicated in the Table of Contents. A brief description of each Chapter is provided in Section I of the applicable Chapters.

1-11. Deleted.

**1-12. Distribution and Revision System.**  
a. Distribution, revision, and mandatory requirements are accomplished in accordance with AR 310-1.

b. Authorization for issue is accomplished in accordance with AR 310-3.

c. Notes, Cautions, and Warnings are used to emphasize important and critical instructions, and are used for the following conditions:

**Note**

An operating procedure, condition, etc., which it is essential to highlight.

**Caution**

An operating procedure, practice, etc., which, if not strictly observed, will result in damage to or destruction of equipment.

**Warning**

An operating procedure, practice, etc., which, if not correctly followed, will result in personnel injury or loss of life.

**1-13. Definitions.** Refer to AR 310-3.

**1-14. Reporting of Recommendations and Comments.** The direct reporting of errors, omissions, and recommendations for improving this Equipment Manual by the individual user, is authorized and encouraged. DA Form 2028 will be used for reporting these improvements. This form may be completed using pencil, pen or typewriter. DA Form 2028 will be completed by the individual user and forwarded directly to: Commanding General, USAAV-COM, P.O. Box 209, Main Office, St. Louis, Mo. 63166.

**1-15. Revisions to this manual shall be published when necessary to add, delete, revise or change. Frequency of revisions will be based on factual data accumulated as a result of maintenance experience. Data will be gathered by field studies, from equipment improvement recommendations, and from any other communications pertaining to the manual and its requirements.**

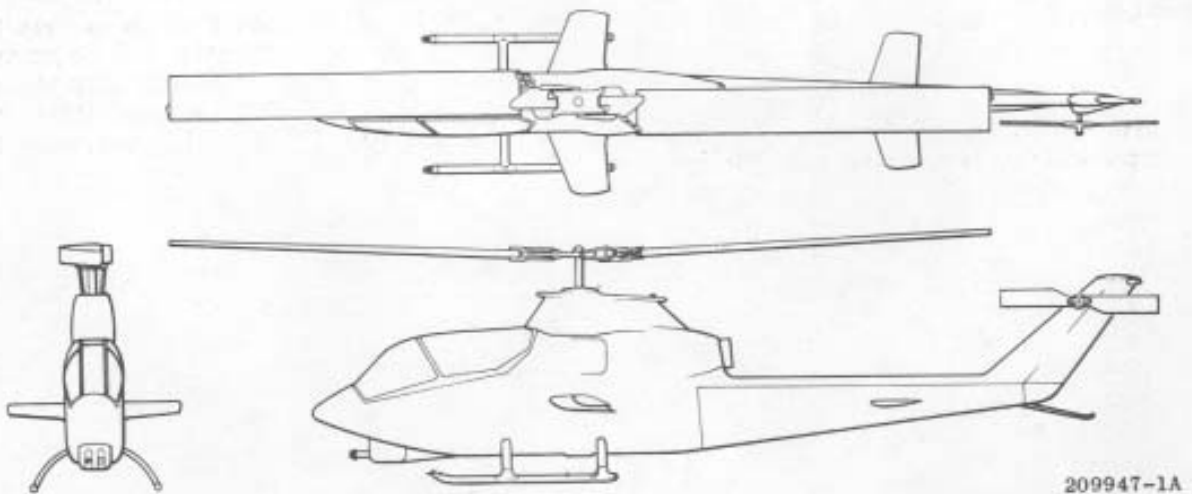

209947-1A

Figure 1-1.  $\frac{1}{4}$  view AH-1G

## CHAPTER 2

### DESCRIPTION

#### Section I — Scope

**2-1. Scope.** The function of Chapter 2 is to describe the helicopter and all its systems and controls which contribute to the physical act of flying the helicopter.

**2-2.** Included in this Chapter is all the emergency equipment that is not part of the auxiliary system. This Chapter contains description only. The procedures are covered elsewhere in this manual.

#### Section II — Aircraft System and Controls Description

**2-3. General Configurations and Arrangement.** The AH-1G Tactical Helicopter, manufactured by Bell Helicopter Company, is a tandem, two-place, high speed conventional helicopter and is designed specifically for the combat role. The Tactical Helicopter is an aggressive high speed combat helicopter designed and built around the fighting mission. The distinctive features are the very narrow sleek fuselage, small tapered swept mid wings, aerodynamic cleanliness, and integral chin turret. The maximum fuselage width is thirty-six inches. The mission profiles completely cover the air to ground environment with suppressive fire at an area, light and hard point targets, while maintaining a fast, light, highly maneuverable helicopter also capable of self protection in hostile air and ground battle situations. The configuration not only will accommodate the present aerial weapons but also advanced type weapons now under development. This helicopter is capable of operating from prepared take-off landing areas, under instrument (IFR) conditions (including light icing), day or night. It can also be used to navigate by dead reckoning or by use of radio aids to navigation. Maximum visibility is afforded the pilot and gunner by the large transparent plastic panels that cover the upper portion of the crew compartment (see figure 2-1).

**2-4.** The Basic configuration of the AH-1G helicopter includes the 7.62 mm automatic gun integrated with the TAT-102A turret and two XM-157 rocket pods. The Scout configuration includes the TAT-102A turret, two XM-18

automatic gun pods and two XM-157 rocket pods. The Hog configuration includes the TAT-102A turret and four XM-159 rocket pods.

**2-5. Armor Protection.** The armor protection (see figure 2-2) in the tactical helicopter is a combination of ceramic and fiberglass composite with a small amount of dual hardness steel.

**2-6. Crew Protection.** Crew protection is provided as follows:

a. Pilot. The pilot's seat is made of dual hardness steel armor. The fixed side panels are made of a ceramic-fiberglass composite material.

b. Gunner. The entire passive defense system for the gunner is made of a ceramic-fiberglass composite material.

**2-7. Component Protection.** Armor plate is located on each side of the engine to protect the engine compressor section and the fuel control. The fuel cells are self sealing as follows: Bottom 33 percent capacity against 50 caliber, center 33 percent capacity against 30 caliber and the top 34 percent is not self sealing. The fuel crossover line is self sealing.

**2-8. Infrared Suppression.** There are no louvers or screens in the side of the cowling to allow a direct view of the engine. The tailpipe is also surrounded by an ejector shroud that extends several inches past the end of the tailpipe. This ejector mixes cool air with the

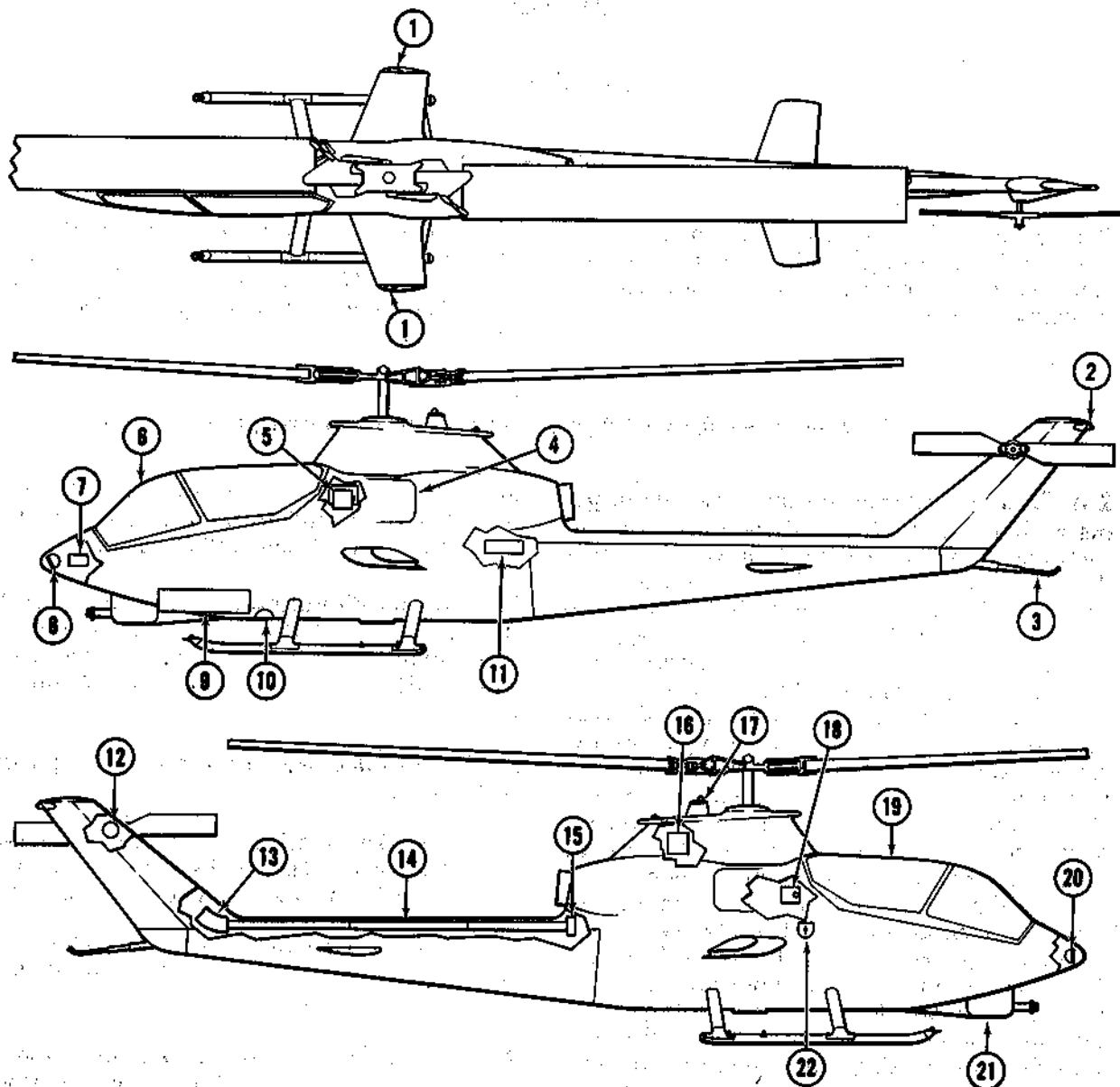

- |                             |  |                              |
|-----------------------------|--|------------------------------|
| 1. Wing Tip Position Lights | 10. Searchlight                                    | 16. Engine Oil Tank          |
| 2. Aft Position Light       | 11. Engine and Transmission Oil Cooler             | 17. Anti-Collision Light     |
| 3. Tail Skid                | 12. 90 Degree Gear Box                             | 18. Hydraulic Reservoir      |
| 4. Engine Air Inlet         | 13. 42 Degree Gear Box                             | 19. Pilot's Canopy Hatch     |
| 5. Hydraulic Reservoir      | 14. Tail Rotor Drive Shaft                         | 20. Right Landing Light      |
| 6. Gunner's Canopy Hatch    | 15. Transmission Compartment and Oil Cooler Blower | 21. TAT-102A or XM-28 Turret |
| 7. Battery                  |  | 22. Fuel Filler Cap          |
| 8. Left Landing Light       |  |                              |
| 9. Ammunition Compartment   |  |                              |

209478-1C

Figure 2-1. General arrangement

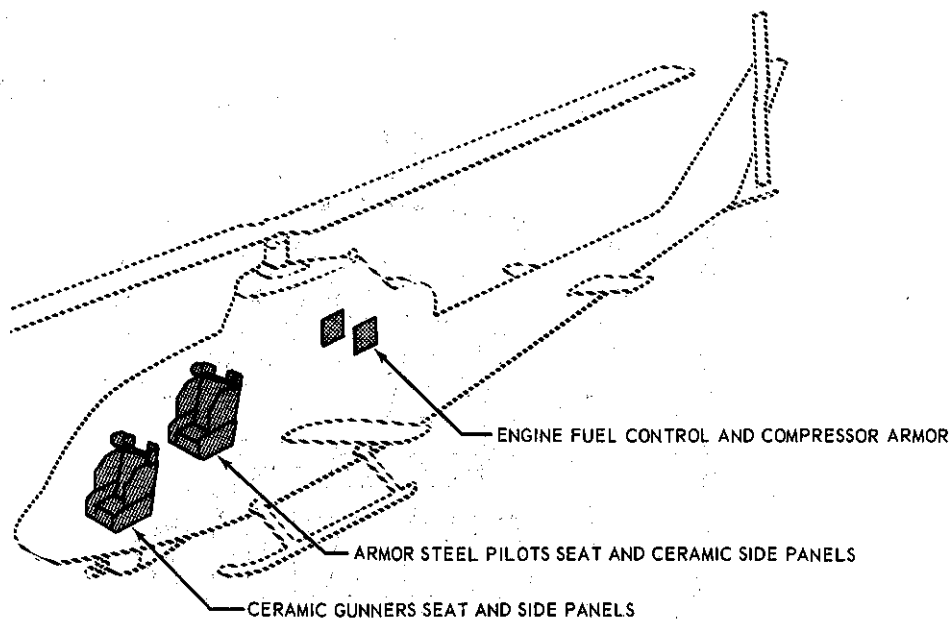

209478-4A

**Figure 2-2. Armor protection**

exhaust gases to reduce the IR radiation. The open end of the tailpipe is directly above the tail boom and directed slightly upward so that a view of the hot end of the turbine is possible only from a position that is above and behind the helicopter.

**2-9. Propulsion.** The propulsion system consists of the engine and drive system and is located aft of the cabin and mounted in the fuselage on a platform. The engine and drive system are enclosed by cowling that can be quickly opened or removed for easy access. This drive system with its independently mounted units and quick disconnect couplings, allows rapid servicing, and repair or replacement under combat conditions without the use of special tools or ground equipment. Use of this type drive system results in maximum availability of the helicopter for mission accomplishment.

**2-10. Engine Compartment Cooling.** Engine compartment cooling is achieved by augmenting the air source through the compartment by an ejector on the tailpipe and by inducing and routing the flow of air to most efficiently cool the area. The engine compart-

ment airflow is shown in figure 2-3. Air is introduced to the upper engine compartment through inlets located aft of the engine inlet. It is then routed down over the engine and aft to the ejector. This use of forced air eliminates the need for conventional holes, screens, and louvers on the side of the cowling and minimizes the drag contributed by the engine compartment cooling. The ejector draws compartment air around and beyond the tailpipe, thus enclosing the exhaust. It extends twelve inches beyond the end of the tailpipe thereby acting as the mixing chamber for cooling the exhaust gas.

**2-11. Transmission Compartment Cooling.** Transmission compartment cooling (see figure 2-3) is achieved by air from the crew compartment and openings in and around the "coolie hat" fairing. The air is routed through the transmission compartment and through the tail rotor driveshaft cover (below the engine) to the tail rotor driveshaft axial blower. The blower source is automatic and dependent only on operation of tail rotor driveshaft. No electrical control nor bleed air switching is required for this exhaust system.

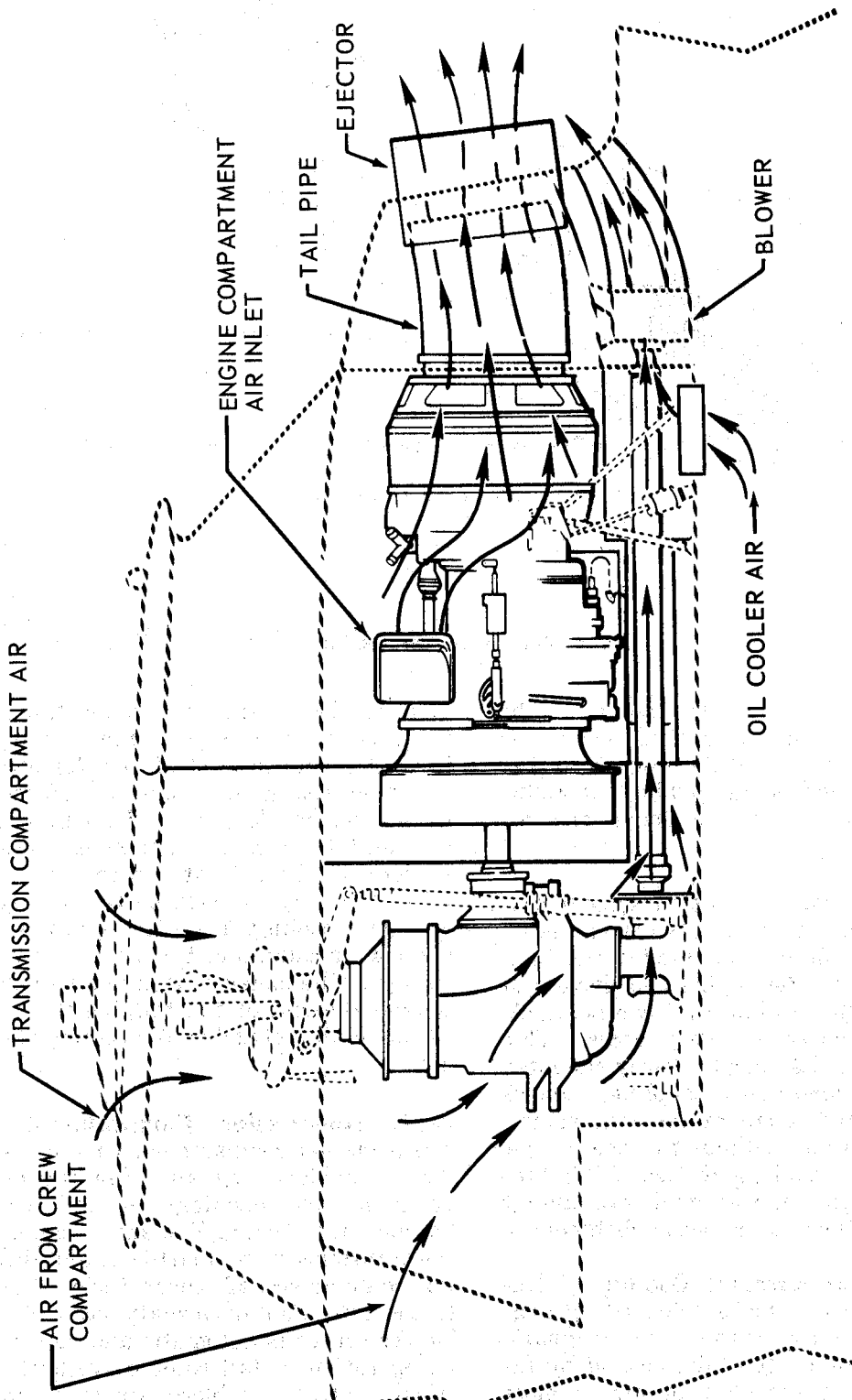

209060-3C

Figure 2-3. Engine and transmission compartment cooling

**2-12. Airframe.** The airframe is an aerodynamically clean narrow structure that is configured around the armament mission, aircrew and weapons to deliver firepower and consists of the fuselage and the tail boom. The forward section consists of two structural beams that are boxed to form a very stiff fuselage.

**2-13. Fuselage.** Honeycomb panel skins and two main beams of one-half inch aluminum honeycomb sandwich construction, which extends from the nose attachment aft to the tail boom, provide the basic fuselage structure. The beams are twenty inches apart in the forward section, are canted outboard aft of the cockpit area, then become the slab-contoured sides of the fuselage from the pylon support area to the tail boom. Flush riveting is employed through the fuselage and the honeycomb panels are used to provide maximum inside space. All main load producing components (transmission, tail boom, landing gear, wings, and turreted weapons) are attached directly to the main beam structure. The fuel cells are supported and protected by the beams in the area of the pylon. The aft (tail boom) section is a semi-monocoque structure with metal covering and attaches to the forward fuselage section with bolts to allow easy removal for repair or replacement. The rear of the tail boom supports the tail rotor, vertical fin, and synchronized elevator. The landing gear is of the skid type, attached to the fuselage at four points. Ground handling wheels are provided as a kit and are quickly installed for moving the helicopter on the ground or removed to present a clean configuration for flight.

**2-14. Crew Compartment.** The upper forward section of the fuselage is the crew compartment. Tandem seating is provided with the pilot elevated in the rear seat. The gunner sits forward in the single contour bubble enclosure to provide maximum visibility for observation and weapon direction. The pilot's visibility is equally free and both have excellent azimuth and elevation coverage. The gunner's cockpit has a forty-five degree windshield which extends aft and contours over the pilot's head. The center windshield panel is continuous from the nose, thus having no horizontal break line to distract the pilot's vision. The windshield is stretched acrylic plastic.

**2-15. Wing.** The short swept back mid wing provides support for external stores. The airfoil is tapered and has a main chord of thirty

inches and a span of 10 feet 11.6 inches. The wing is cantilevered from the airframe. Each wing has two hard point locations for external stores. The hard points support 550 pounds each.

**2-16. Crew Configuration.** The crew shall consist of the pilot and gunner or the pilot alone.

**2-17. Principal Dimensions — Maximum.** Maximum dimensions of the helicopter are shown in figure 2-4.

**2-18. Weights.** The helicopter weight empty and gross operating weight will change according to the configuration or equipment installed for the type of mission to be performed. Refer to Chapter 12, Weight and Balance Computation.

**2-19. Engine.** The turbine engine (see figure 2-5) and its accessories are located aft of the transmission and mounted on a platform deck to provide maximum accessibility for servicing and maintenance. The complete engine and power transfer system is enclosed in an easily opened or quickly removable lightweight cowling. The engine is a free turbine type designed for low fuel consumption, minimum size and weight, and maximum performance.

**2-20.** The engine consists of a reduction gear section, axial-centrifugal compressor diffuser, combustion compressor, diffuser, combustion chamber, gas producer turbine, power turbine (free power), power shaft and exhaust diffuser. The compressor consists of five axial stages and one centrifugal impeller. The gas producer turbine drives the compressor and the power turbine drives the power shaft. An acceleration air-bleed assembly mounted on the aft face of the diffuser section improves the engine performance during starts and acceleration. The power shaft extends coaxially through the compressor rotor and drives the reduction gearing at the forward end of the engine. Power is extracted through an internally-splined output gear shaft driven by the reduction gearing. The through shaft arrangement permits mounting the accessory drives and power take-offs on the inlet housing, at the cool end of the engine, thus avoiding the problems of a hot end drive. Bleed air for heating purposes is taken from the outlet side of the centrifugal impeller. The free-power part of the engine eliminates the need of a clutch and provides smooth,



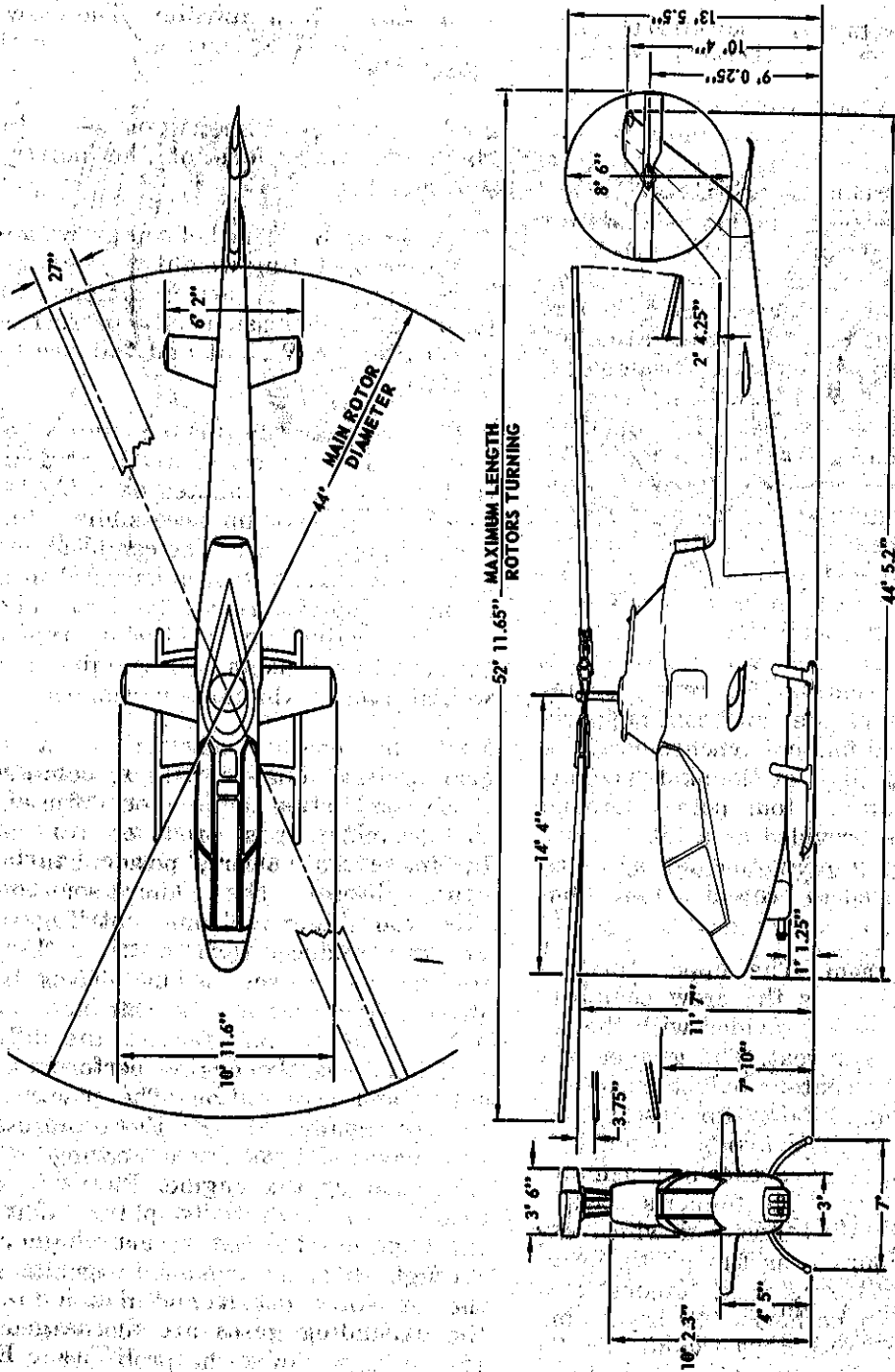

209900-9

Figure 2-4. Principal dimensions

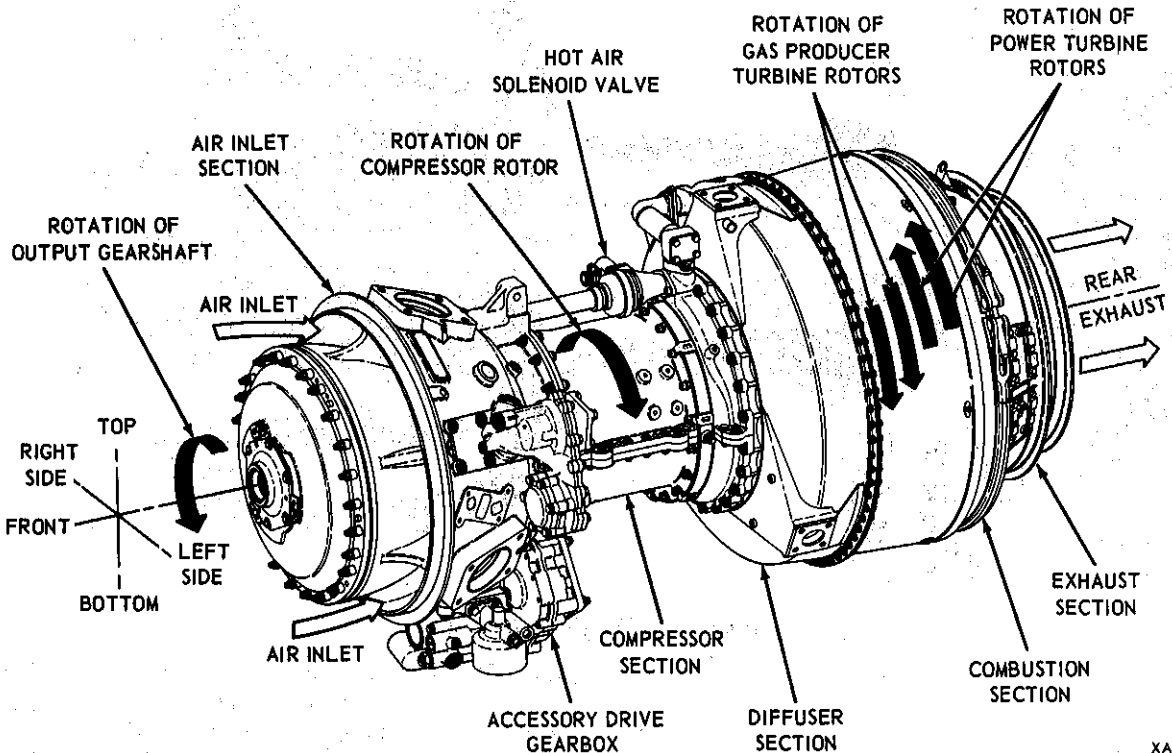

XA-699-114

**Figure 2-5. Engine**

and trouble-free engagement of the drive system.

**2-21.** The T53-L-13 engine's sea level static uninstalled military rated power equals 1400 shaft horsepower. However, in this installation, the engine is torque-limited by the pilot to 1100 hp for military and normal power at 6600 rpm.

**2-22.** Deleted.

Combustion occurs and the expanding gases are discharged through the turbine and exhaust diffuser. Energy is extracted from the gases by two separate and independent turbines (gas producer and power). The gas producer turbines drive the compressor rotor, which compresses the air. The power turbines supply the driving force for the output gearshaft through the reduction gearing.

**2-24.** Deleted.

**2-23. Principles of Operation.** Air enters the inlet housing assembly (see figure 2-6) and is directed into the compressor section by the variable inlet guide vane assembly. The air is compressed by the five-stage axial compressor rotor assembly and the centrifugal compressor impeller. The compressed air flows through the diffuser housing and into the combustion chamber where a portion of it mixes with fuel from the atomizers to form a combustible mixture.

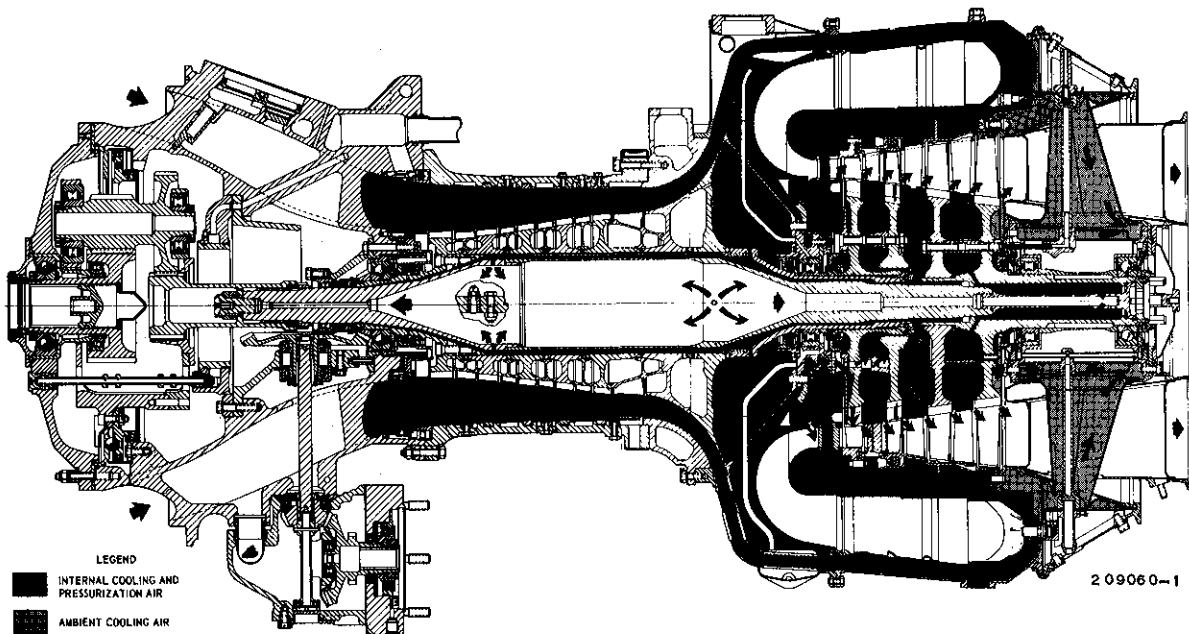

Figure 2-6. Engine air flow

**2-25. Engine Fuel Control Systems.** From the helicopter fuel tanks, fuel enters and passes through the fuel regulator assembly to the starting and main discharge ports. Engine fuel control is accomplished by a hydromechanical type fuel control system consisting of a fuel regulator assembly and over-speed governor assembly. An emergency fuel metering system is provided as an integral part of the fuel control system. The fuel control regulator assembly supplies fuel to the starting fuel solenoid valve and starting fuel manifold and to the main fuel manifolds by means of a fuel pump. A main governor, incorporated in the regulator assembly, determines the rate at which fuel is supplied to the engine in relation to the gas producer turbine speed (nI), altitude, compressor inlet temperature, and manual throttle selection. The regulator assembly limits engine fuel flow to the maximum permissible rate under all operating conditions. The overspeed governor assembly is mounted on the fuel control regulator assembly and functions to reduce the fuel flow when power turbine speed (nII) exceeds the selected rpm. The electrical cable assembly is connected to the fuel system at two points, at the starting fuel solenoid and at the changeover valve on the fuel regulator.

**2-26.** The engine fuel system consists of the engine fuel control, starting fuel solenoid valve, flow divider, starting and main fuel manifolds, starting fuel nozzels and fuel atomizers. Energizing the ignition system actuates the solenoid valve, which allows starting fuel to enter the starting fuel manifold, four starting fuel nozzels, and into the combustion chamber where it is ignited by four igniter plugs. After combustion occurs and the starter ignition switch is released, the starting fuel solenoid valve shuts off the starting fuel flow. The main fuel system delivers main fuel to the combustion chamber through fuel atomizers. Minimum fuel pressure to actuate the fuel outlet foot valve in the fuel regulator is obtained at 8 to 13 percent nI speed. Main fuel flows from the fuel regulator through the flow divider, where it is split into primary and secondary paths and delivers fuel to the main fuel manifold assembly. Fuel from the manifold is discharged through 22 fuel atomizers into the combustion chamber where it is ignited by the burning starting fuel. Main fuel flow is maintained as the flame is propagated. After engine shutdown, a pressure activated valve automatically drains any remaining unburned fuel from the combustion chamber and from the main fuel manifolds through the flow divider.

■ 2-27. Deleted.

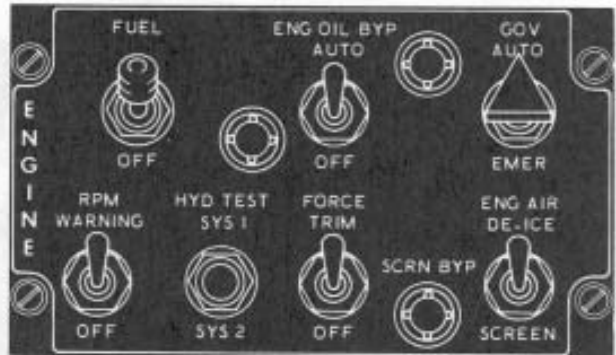

Figure 2-7. Engine control panel

lower altitudes (below 10,000 feet) satisfactory emergency switchover may be made by retarding the power control until a reduction of (nII) rpm is noted and then switching to emergency.

**2-28. Fuel Control System Operation.** Fuel flow control is accomplished by operation of fuel switch located on the left console's engine control panel (see figure 2-7). The GOV AUTO/EMER switch is also located in the same panel. The engine fuel and power control system permits the pilot to obtain maximum performance from the engine with a minimum of attention.

**2-29. Emergency Fuel Flow.** The switchover to emergency fuel flow is accomplished by retarding the power control (throttle) to flight idle, moving the GOV AUTO/EMER switch to EMER, and then advancing the power control to operational rpm. The emergency control manually meters fuel to the engine without the incorporation of any automatic features. It is possible to fly the helicopter by utilizing smooth, coordinated use of the rotating power control. When operating on emergency control, it is possible to overspeed the gas producer turbine and the power turbine, and to exceed red-line tailpipe temperature.

**Note**

Retarding the power control to 70 percent gas producer rpm or flight idle detend position before switching to emergency control will effect a satisfactory changeover at any altitude. At

**2-30. Power Control (Throttle).** The rotating grip-type power controls are located on the collective pitch controls (figure 2-8 and gunner's, figure 2-9). The power control is a simple single throttle grip which is used for starting engine, adjusting flight idle, autorotational landings, and in full decrease serves as fuel shut off. The throttle grip is rotated to the left to increase or to the right to decrease power. Friction can be induced into the throttle grip by rotating the ring at the upper end of the throttle grip. Rotating the ring to the left increases friction in the system and prevents grip creepage. A 28-volt dc powered solenoid-operated idle detent is incorporated in the throttle to prevent inadvertent closing of the throttle during flight or ground run. To bypass the idle detent, depress and hold the engine idle release switch until gas producer speed of 40 to 44 percent rpm is obtained, then release switch and close throttle. The idle detent limits only the decrease rotation of the rotating grip. Under normal flight conditions the power plant free power turbine rpm speed is controlled by the power turbine speed governor. The gas producer speed governor safeguards the engine against overloading; and on acceleration and deceleration, the control prevents engine damage or combustion blowout due to sudden changes in power selection made at any rate and in any sequence.

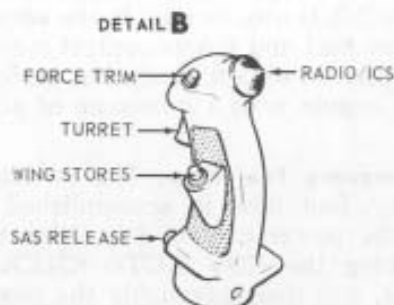
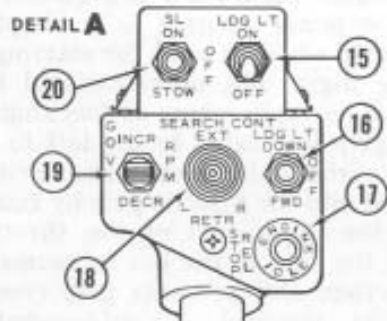
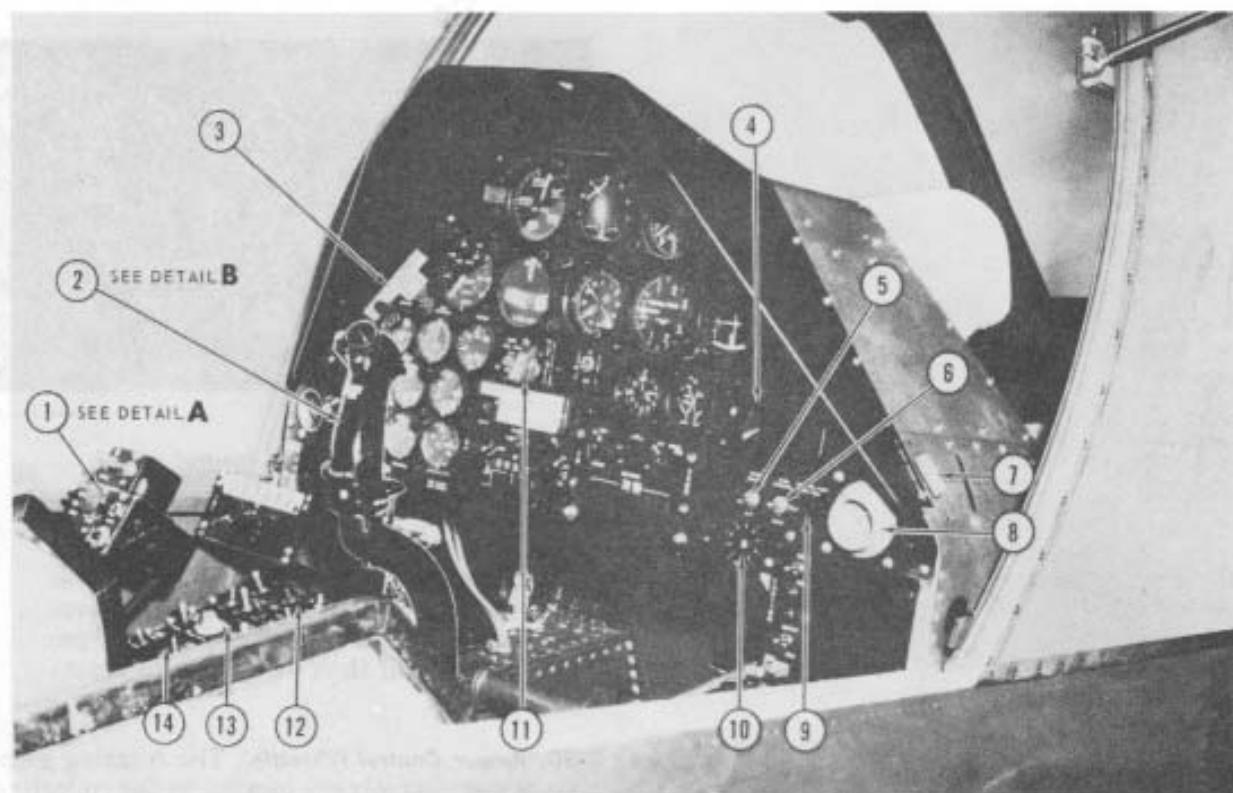

1. Collective Pitch Control
2. Cyclic Stick
3. Go-No-Go Placard\*
4. Ash Tray
5. Pitot Heater Switch
6. Rain Removal - Heat Switch
7. Defroster Outlet Control
8. Air Vent
9. Heat or Vent Control
10. Heat Selector Switch

11. Wing Stores Emergency Jettison Switch
12. Engine Control Panel
13. Wing Stores Control Panel
14. Turret Control Panel
15. Landing Light Switch
16. Landing Light DOWN-FWD Switch
17. Engine Idle Release Switch
18. Searchlight EXT-RETR-L-R Switch
19. Governor RPM INCR-DECR Switch
20. Searchlight ON-STOW Switch

\*Refer to Chapter 14, figure 14-5 for decal data.

209900-8A

Figure 2-8. Pilot's station

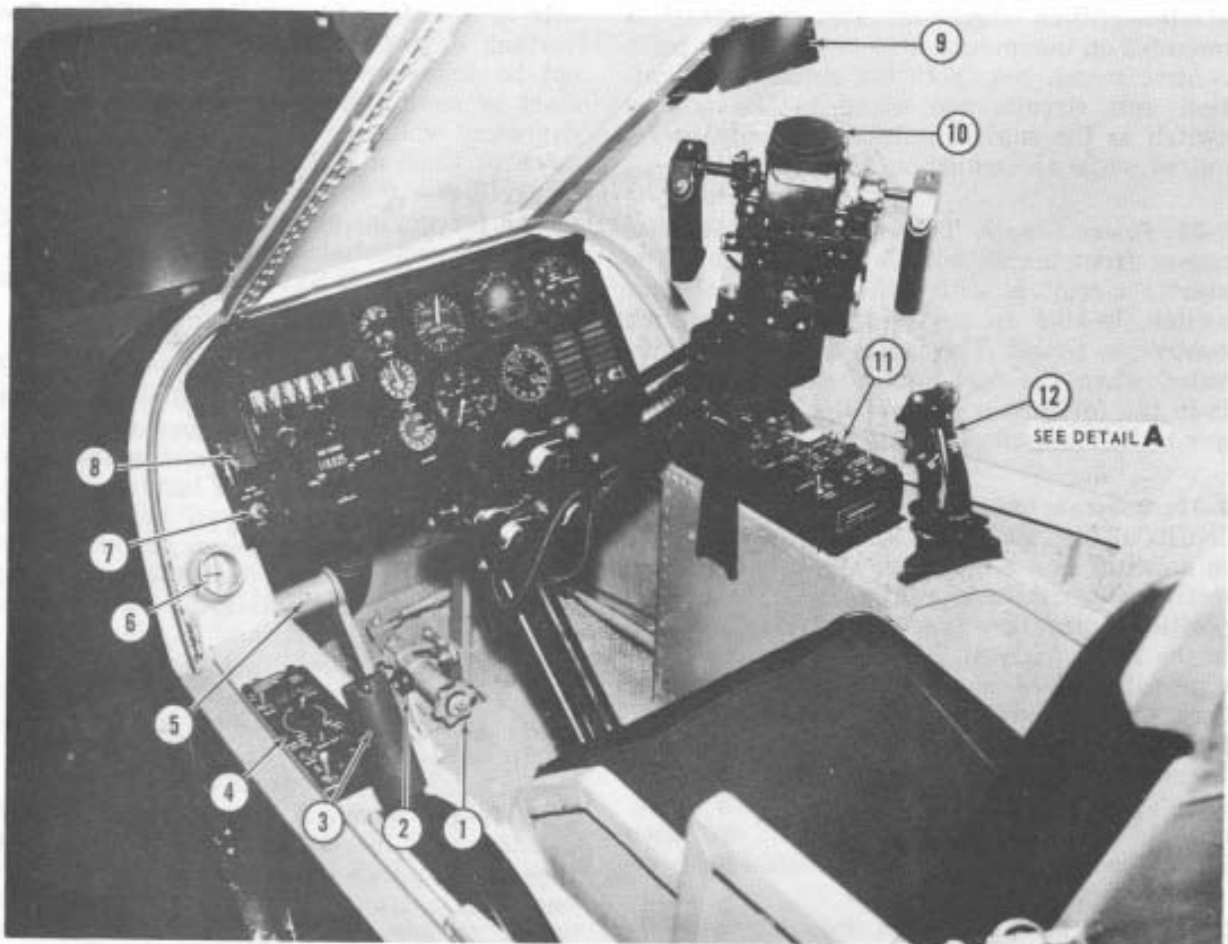

1. Directional Control Pedals Adjuster
2. Shoulder Harness Control
3. Collective Pitch Control
4. Miscellaneous Control Panel
5. Directional Control Pedals
6. Air Vent
7. Emergency Hydraulic Control Switch
8. Wing Stores Jettison Switch
9. Rear View Mirror
10. Sighting Station Head
11. Armament Control Panel
12. Cyclic Stick

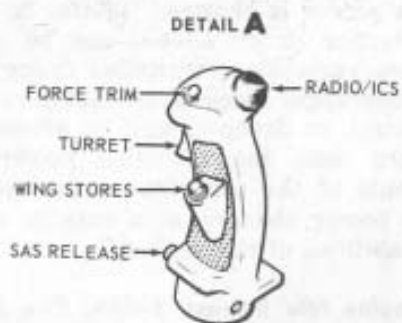

209900-7A

Figure 2-9. Gunner's station

**2-31. Starter — Ignition System.** A combination starter-ignition trigger-actuated snap switch is mounted on the underside of the collective pitch control switch box. Both the starter and ignition unit circuits are wired to the trigger switch as the engine ignition will only be required while accomplishing engine starts.

**2-32. Power Supply.** The circuits are supplied power from the 28 volt dc essential bus. The starter circuit is activated when the trigger switch, located on the pilot's collective pitch control, is pulled. The ignition circuit is activated when the fuel switch (see figure 2-7) is in the forward position (ON) and the trigger switch is pulled.

**2-33. Governor RPM Switch.** The GOV RPM INCR/DECR switch (see figure 2-8) is mounted in a switch box attached to the end of the collective pitch control lever. The switch is a three-position momentary type and is held (forward) in the INCR position to increase the power turbine (nII) speed or (aft) to DECR position to decrease the power turbine (nII) speed. Regulated power turbine speed may be adjusted in-flight, through the operating range of 8000 to 6600 rpm, by movement of the switch as required. Electrical power for circuit operation is supplied by the 28 volt dc essential bus.

**2-34. Droop Compensator.** A droop compensator is installed in the governor control linkage to maintain a constant nII speed, selected by the pilot, as power is changed. (Refer to Chapter 9.) Governor droop should not be confused with rpm variations (transient droop) due to the acceleration-deceleration limiters in the fuel control, or droop caused by attempting to use more than the available power. Rapid movements of the collective control stick may require power changes at a rate in excess of the capabilities of the engine.

**2-35. Engine Idle Release Switch.** The ENGINE IDLE REL switch (see figure 2-8) is a push button, momentary-on, type switch mounted in a switch box attached to the end of the collective pitch control lever. The gunner's idle release switch is located in the forward area of the left console (see figure 2-9). The pushbutton switch energizes an electrical solenoid with a retractable plunger. The solenoid is mounted so that the plunger acts as a stop in the power control system linkage. The stop prevents the pilot from accidentally retarding the power

control beyond the flight idle position. This acts as a safety feature by preventing inadvertent engine shutdown. The switch need not be depressed when performing an engine start or runup; however, the switch must be depressed when accomplishing an engine shutdown or when it is desired to retard the power control below the flight idle position. Electrical power for circuit operation is supplied by the 28 volt dc essential bus. Circuit protection is provided by IDLE STOP REL circuit breaker on the circuit breaker panel.

**2-36. Engine Instruments and Indicators.** The pilot's engine instruments and indicators are mounted in the instrument panel and the right console. The gunner's instruments and indicators are all mounted in his instrument panel. The engine instruments and indicators consist of the following: torque meter, exhaust temperature indicator, dual tachometer, gas producer tachometer indicator, oil pressure indicator, oil pressure low caution light, oil temperature indicator, fuel quantity indicator, fuel gage test switch, fuel quantity caution light, fuel pressure indicator, and engine fuel pump caution light.

**2-37. Torque Meter.** A torque meter indicator (see figure 2-10) is located on the left center area of the pilot's instrument panel and is connected to a transmitter which is part of the engine oil system. The gunner's torque meter is located at the top left area of his instrument panel (figure 2-11). The torque meter indicates torque pressure in psi readings of the torque imposed upon the engine output shaft. The torque meter circuit is powered by 28 volts ac and is protected by the TORQUE PRESS IND circuit breaker located on the circuit breaker panel mounted on the left console.

**Note**

To convert torque pressure (psig) to horsepower multiply torque X nII rpm X 0.00852.

**2-38. Exhaust Gas Temperature Indicator.** An exhaust gas temperature indicator (see figure 2-10) is located in the left area of the pilot's instrument panel. Also an exhaust gas temperature indicator (see figure 2-11) is located in the lower left area of the gunner's instrument panel. The indicator receives temperature indications from the bayonet type thermocouples mounted in the engine exhaust diffuser section.



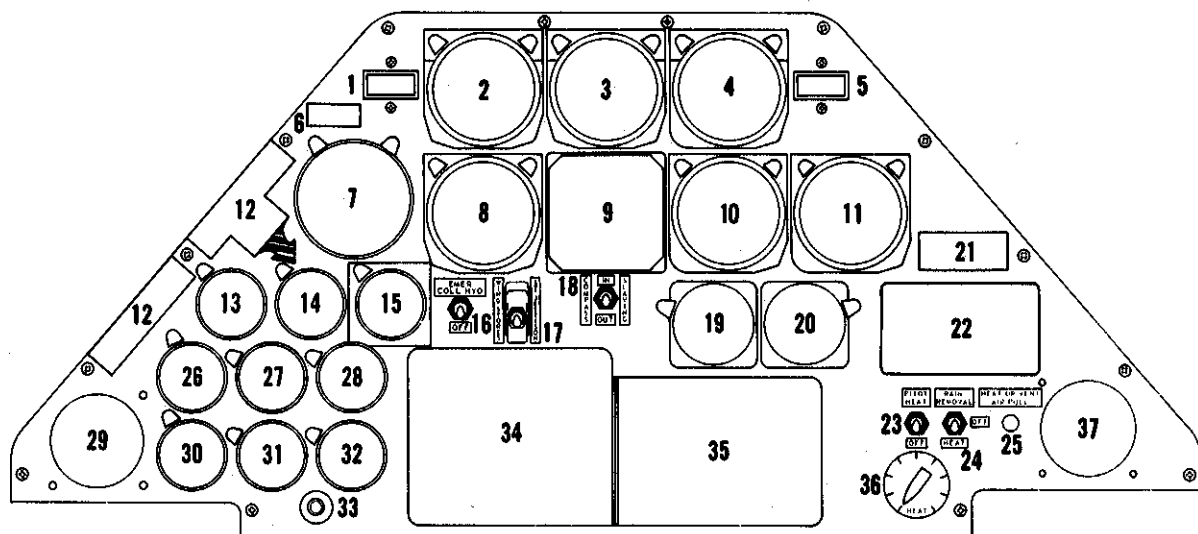

- |   |  |
|---|--|
| 1. Master Caution Light                       | 19. Clock                                  |
| 2. Airspeed Indicator                         | 20. Volt-Ammeter Indicator                 |
| 3. Attitude Indicator                         | 21. Transmitter Selector Decal             |
| 4. Altimeter                                  | 22. Ash Tray                               |
| 5. RPM Warning Light                          | 23. Pitot Heat Switch                      |
| 6. Radio Call Letters                         | 24. Rain Removal - Heat Switch             |
| 7. Dual Tachometer Indicator                  | 25. Heat and Vent Control                  |
| 8. Turn and Slip Indicator                    | 26. Fuel Pressure Indicator                |
| 9. Radio Magnetic Compass                     | 27. Transmission Oil Temperature Indicator |
| 10. Rate of Climb Indicator                   | 28. Engine Oil Temperature Indicator       |
| 11. Omni Indicator                            | 29. Air Vent                               |
| 12. GO NO GO Placard*                         | 30. Fuel Quantity Indicator                |
| 13. Exhaust Gas Temperature                   | 31. Transmission Oil Pressure Indicator    |
| 14. Gas Producer Tachometer                   | 32. Engine Oil Pressure Indicator          |
| 15. Torque Meter                              | 33. Fuel Gauge Test Switch                 |
| 16. Emergency Collective Hydraulic Switch     | 34. ARC 51 BX Control Panel                |
| 17. Wing Stores Jettison Switch - (Emergency) | 35. ARC 54 Control Panel                   |
| 18. Compass Slaving Switch                    | 36. Temperature Control                    |
|   | 37. Air Vent                               |

\*Refer to Chapter 14, figure 14-5 for decal data.

209070-4A

Helicopter serial number 66-15249 through 66-15257

Figure 2-10. Pilot's instrument panel (Sheet 1 of 2)



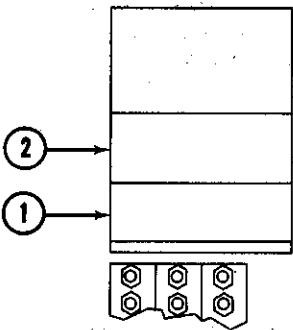
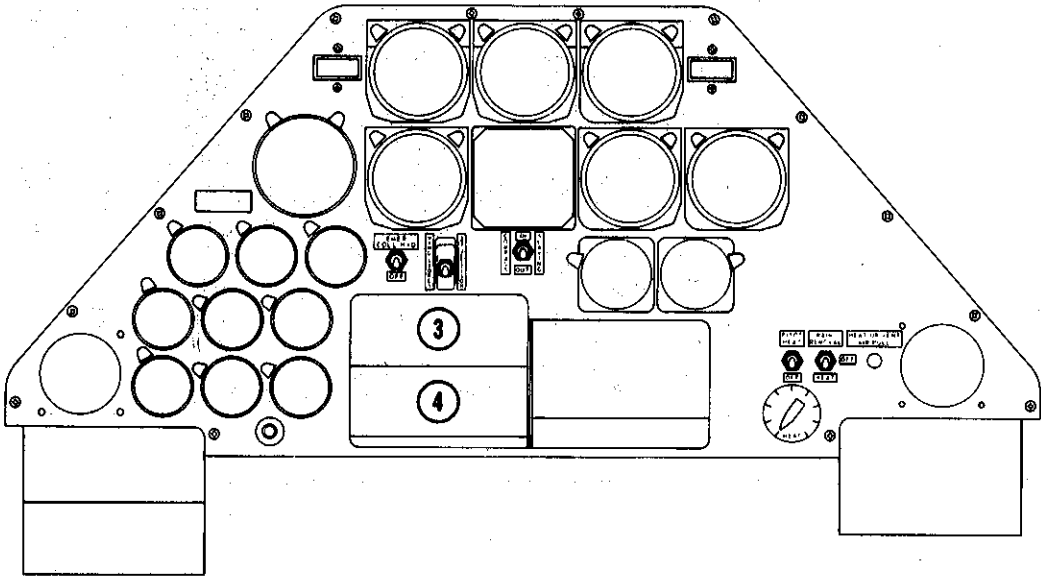

1. Miscellaneous Control Panel
2. Electrical Power Control Panel
3. Turret Control Panel
4. Wing Stores Control Panel
5. ARC-51BX UHF Control Panel
6. ARN-83 ADF Control Panel
7. APX-44 Transponder Control Panel
8. Blank Panel
9. Blank Panel
10. Lighting Control Panel
11. Blank Panel

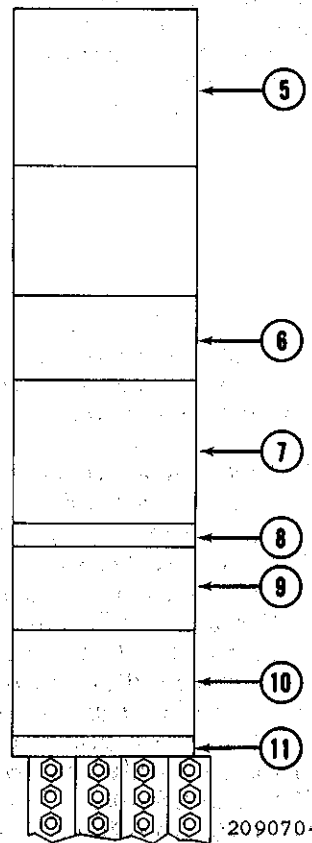

209070-16

Helicopters serial number 66-15258 and subsequent

Figure 2-10. Pilot's instrument panel (Sheet 2 of 2)

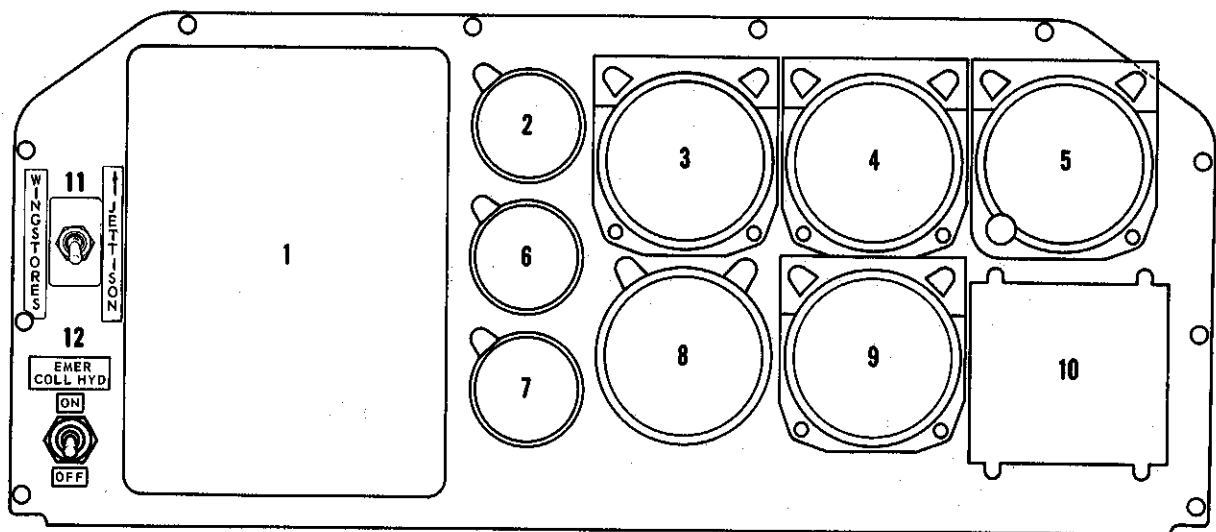

- |   |                               |   |
|---|-------------------------------|---|
| 1. Wilcox 807-A Radio and Signal Distribution Panel | 5. Altimeter                  | 10. Caution Panel                         |
| 2. Torque Meter Indicator                           | 6. Gas Producer Tachometer    | 11. Wing Stores Jettison Switch           |
| 3. Airspeed Indicator                               | 7. Exhaust Gas Temperature    | 12. Emergency Collective Hydraulic Switch |
| 4. Attitude Indicator                               | 8. Dual Tachometer Indicator  |   |
|   | 9. Radio - Magnetic Indicator |   |

209070-3A

Figure 2-11. Gunner's instrument panel

The gage temperature indications are in degrees centigrade and electrical power is not required as the system is self generating.

**2-39. Dual Tachometer.** The dual tachometer (see figure 2-10) is located in the left area of the pilot's instrument panel. The gunner's dual tachometer (see figure 2-11) is located in the lower left area of his instrument panel. The indicator is for both the engine and main rotor. The outer scale of the indicator is for power turbine rpm, and the smaller inner scale is for the main rotor rpm. Power for operation of the indicators is provided by two tachometer generators mounted one on the engine and one on the transmission. These systems are self-generating, therefore a connection to the electrical system is not required. Normal operation of the helicopter is evident when the power turbine (engine) and rotor rpm indicator needles are in synchronization.

**2-40. Gas Producer Tachometer.** The gas producer tachometer (see figure 2-10), located in the left center area of the pilot's instrument panel, indicates the rpm of the gas producer turbine. The indicator is powered by a tachometer generator geared to the engine gas producer shaft and therefore does not depend on the helicopter's electrical system. The indicator readings are in percent rpm of gas producer turbine speed.

**2-41. Oil Pressure Indicator.** The engine oil pressure indicator (see figure 2-10) located in the lower left area of the pilot's instrument panel, receives pressure indications from the pressure transmitter and provides readings in psi. The oil pressure indicator and transmitter are electrically powered by the 26 volt ac system.

**2-42. Low Pressure — Caution.** One Engine OIL PRESSURE caution worded segment is located

in the pilot's right console mounted CAUTION panel (see figure 2-12). Also an ENGINE OIL PRESS caution worded segment is located in the gunner's instrument panel mounted CAUTION panel. The light is connected to a low pressure switch, which makes contact upon a pressure drop below safe limits, and illuminates the caution light. The circuit is powered by 28 volt dc and is connected to the essential bus.

either pump inoperative the low level switches are connected in series. The switches function to close the circuit and illuminate the worded segment panel lights when there is enough

**2-43. Oil Temperature Indicator.** The engine oil temperature gage is located in the lower left area of the pilot's instrument panel (see figure 2-10). The gage is connected to an electrical resistance type thermocouple and indicates the temperature of the engine oil at the oil inlet. The oil temperature indicator is powered by 28 volt dc and is connected to the essential bus.

**2-44. Fuel Quantity Indicator.** The fuel quantity indicator is located in the left area of the pilot's instrument panel (see figure 2-10). This instrument is a transistorized electrical receiver which continuously indicates the quantity of fuel in pounds and is powered by the 115 volt ac system and circuit protection is provided by a circuit breaker on the circuit breaker panel. The fuel quantity indicator is connected to capacitor-type fuel quantity transmitters in the forward and aft fuel cells. The indicator readings shall be multiplied by 100 to obtain fuel quantity in pounds.

**2-45. Fuel Gauge Test Switch.** A push-button momentary ON switch (see figure 2-10) is located in the left area of the pilot's instrument panel. The switch functions to provide a means of testing the indicator and circuit for operation. When the switch button is DE-PRESSED and HELD IN, the fuel quantity indicator pointer moves from the actual quantity reading toward a lesser quantity reading. Upon release of the test button the indicator needle will return to the actual fuel reading.

**2-46. Fuel Quantity Caution Light.** A caution panel segment worded 10% FUEL is located in the pilot's caution panel (see figure 2-12) and the gunner's caution panel (see figure 2-11). The light switch assembly is located in each fuel cell through a low fuel level relay. With both pumps operating the low level switches are connected in parallel and with

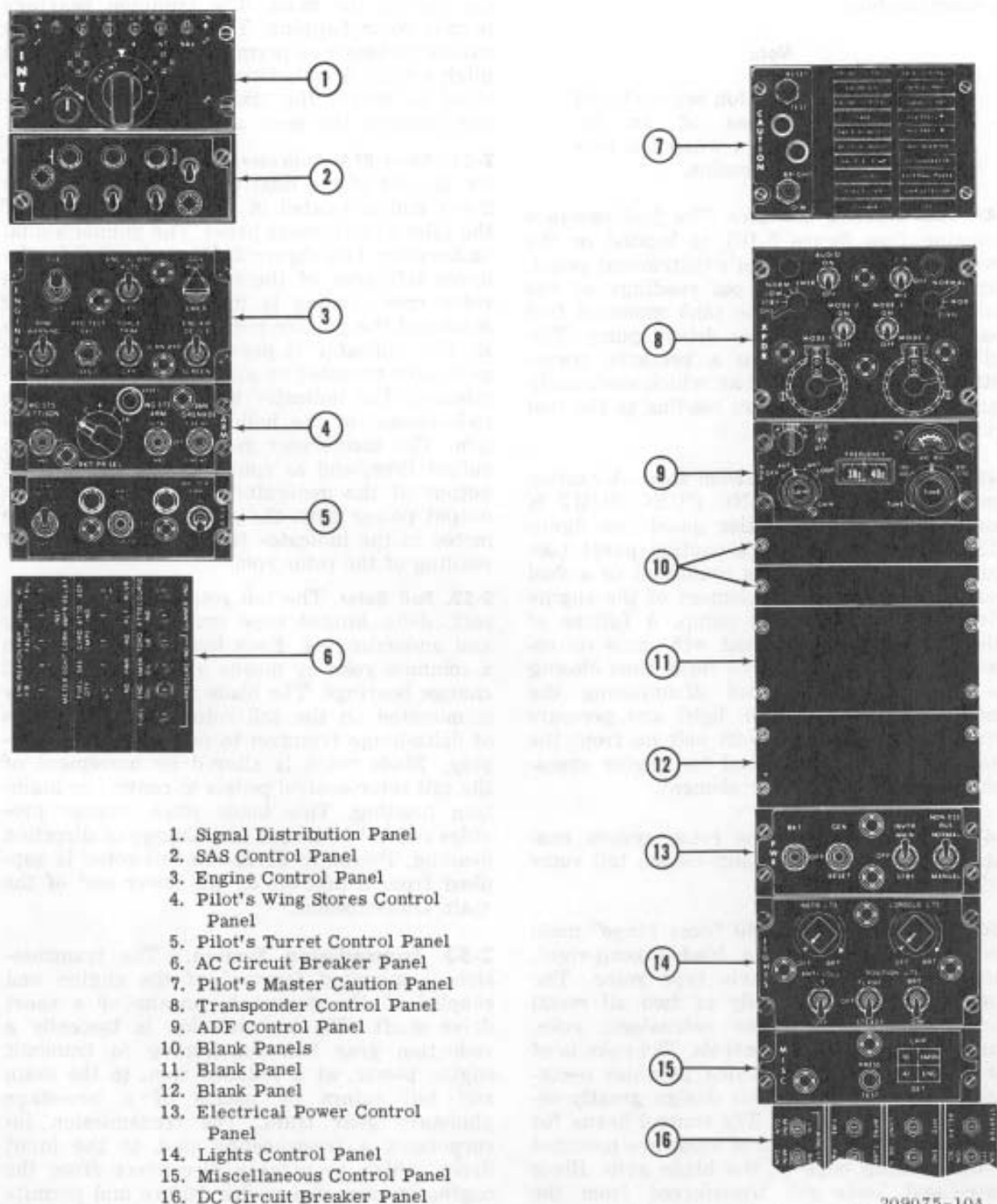

1. Signal Distribution Panel
2. SAS Control Panel
3. Engine Control Panel
4. Pilot's Wing Stores Control Panel
5. Pilot's Turret Control Panel
6. AC Circuit Breaker Panel
7. Pilot's Master Caution Panel
8. Transponder Control Panel
9. ADF Control Panel
10. Blank Panels
11. Blank Panel
12. Blank Panel
13. Electrical Power Control Panel
14. Lights Control Panel
15. Miscellaneous Control Panel
16. DC Circuit Breaker Panel

209075-10A

Figure 2-12. Pilot's consoles

fuel remaining for approximately 20 minutes of fuel at cruise power. Electrical power for circuit operation is derived from the 28 volt dc essential bus.

**Note**

The 10% FUEL caution segment will illuminate, regardless of an in-operative boost pump, when ten percent of usable fuel remains.

**2-47. Fuel Pressure Indicator.** The fuel pressure indicator (see figure 2-10) is located in the lower left area of the pilot's instrument panel. This indicator provides psi readings of the fuel as delivered from the tank mounted fuel boost pumps to the engine driven pump. The indicator is connected to a pressure transmitter, powered by 26 volt ac, which electrically transmits the fuel pressure reading to the fuel pressure indicator.

**2-48. Engine Fuel Pump Caution Light.** A caution panel worded segment ENG FUEL PUMP is located in the pilot's caution panel (see figure 2-12) and in the gunner's caution panel (see figure 2-11). The light is connected to a fuel pressure switch at each element of the engine driven dual element fuel pump. A failure of either engine pump element will cause its respective pressure switch to close, thus closing the electrical circuit and illuminating the caution light. The caution light and pressure switches are powered by 28 volt dc from the essential bus. Sufficient fuel for engine operation is delivered by either element.

**2-49. Rotor System.** The rotor system consists of the main rotor, anti-torque tail rotor and rotor tachometer.

**2-50. Rotor System.** The 540 "door hinge" main rotor assembly is a two bladed semi-rigid, underslung feathering axis type rotor. The assembly consists basically of two all metal blades, blade grips, yoke extensions, yoke, trunnion, and rotating controls. The yoke is of flat steel plate design, which provides necessary inplane stiffness. This design greatly reduces 2/rev. vibrations. The control horns for cyclic and collective control input are mounted on the trailing edge of the blade grip. Blade centrifugal loads are transferred from the blade grips to the extensions by wire wrapped type tension-torsion straps. The main rotor is mounted on the first set of splines from the

top of the mast by the trunnion. The trunnion is supported underneath by a split cone set and retained on the mast by a nut threaded to the top of the mast. The trunnion bearings permit rotor flapping. The blade grip to yoke extension bearings permit cyclic and collective pitch action. A collective friction device is provided to reduce the transient relative oscillation between the mast and collective sleeve.

**2-51. Rotor RPM Indicator.** The rotor rpm indicator is part of the dual tachometer (see figure 2-10) and is located in the upper left area of the pilot's instrument panel. The gunner's dual tachometer (see figure 2-11) is located in the lower left area of the instrument panel. The rotor rpm reading is indicated on the inner scale and the pointer needle is marked with an R. The indicator is powered by a tachometer generator mounted on and driven by the transmission. The indicator and generator operate independent of the helicopter's electrical system. The tachometer generator is a variable output type, and as rpm changes, the current output of the generator varies. The variable output power from the generator operates the motor in the indicator thus providing a direct reading of the rotor rpm.

**2-52. Tail Rotor.** The tail rotor is a two bladed, soft, delta hinged type employing preconing and underslinging. Each blade is connected to a common yoke by means of a grip and pitch change bearings. The blade and yoke assembly is mounted on the tail rotor shaft by means of delta-hinge trunnion to minimize rotor flapping. Blade pitch is altered by movement of the tail rotor control pedals to control or maintain heading. This blade pitch change provides control of torque and change of direction heading. Power to drive the tail rotor is supplied from a take-off on the lower end of the main transmission.

**2-53. Transmission System.** The transmission is mounted forward of the engine and coupled to the engine by means of a short drive shaft. The transmission is basically a reduction gear box functioning to transmit engine power, at a reduced rpm, to the main and tail rotors by means of a two-stage planetary gear train. The transmission incorporates a freewheeling unit at the input drive, which provides a disconnect from the engine in case of a power failure and permits the main rotor and tail rotor to rotate in order to accomplish safe autorotational landings. The tail rotor is powered by take-off on the lower

aft section of the transmission. Accessory mounting pads and drives are included on the transmission for the rotor tachometer generator and hydraulic pumps.

**2-54. Transmission Oil System.** Transmission lubrication is accomplished by a self contained pressure oil system with the oil pump immersed in the wet sump located at the lower end of the transmission unit. Quick-disconnect couplings are used on the driveshaft and electrical connections which permit rapid removal or replacement of the transmission as an assembly. Oil specification, grade and capacity of the transmission are shown on the Servicing Diagram, (see figure 2-13).

**2-55. Transmission Oil Cooler.** A transmission oil cooler, (see figure 2-14) attached to the engine oil cooler, is incorporated in the transmission oil system. Transmission oil is cooled by the same fan that cools the engine oil. No manual control has been provided as it is a self-contained system with independent thermostatic valves and bypass provisions as a part of the transmission oil cooling system. The oil system has an automatic emergency oil cooler bypass system that routes the oil around the oil cooler if the oil cooler is ruptured.

**2-56. Transmission Indicators.** The transmission indicators consist of oil pressure indicator, oil pressure caution light, oil temperature indicator, oil temperature caution light, chip detector caution segment and oil bypass caution light.

**2-57. Oil Pressure Indicator.** The transmission oil pressure indicator (see figure 2-10) is located in the lower left area of the pilot's instrument panel. The indicator receives pressure indications from the transmission oil pressure transmitter and indicates pressure in psi. The oil pressure indicator and transmitter are electrically powered by the helicopter's 26 volt ac circuit.

**2-58. Oil Pressure Caution Light.** The caution panel worded segment "XMSN OIL PRESS" is located in the pilot's caution panel (see figure 2-12) and in the gunner's caution panel (see figure 2-11). The lights are connected to a transmission mounted pressure switch. A drop in oil pressure below safe operating limits, closes the electrical circuit and illuminates the

caution light. The circuit is powered by 28 volt dc from the essential bus.

**2-59. Oil Temperature Indicator.** The transmission oil temperature indicator (figure 2-10) is located in the lower left area of the pilot's instrument panel. An electrical resistance type thermobulb transmits the oil temperature reading to the indicator unit. The indicator circuit is powered by 28 volt dc from the essential bus.

**2-60. Oil Temperature Caution Lights.** The caution panel worded segment "XMSN OIL HOT" is located in the pilot's caution panel (see figure 2-12) and in the gunner's caution panel (see figure 2-11). The lights are connected to a transmission mounted thermostat which, when heated by transmission oil to a temperature above safe operating limits, closes an electrical circuit and illuminates the caution light. The caution light circuit is powered by 28 volt dc from the essential bus.

**2-61. Chip Detector Caution Segment.** The chip detector segment (see figure 2-15) is a push-to-test type worded assembly. The electrical circuit to this unit is closed when the master caution panel worded segment "CHIP DETECTOR" is illuminated. The illumination of the master caution panel segment indicates a grounded assembly in one of the following components: 42 degree gear box, transmission, 90 degree gear box or engine. With the master caution panel "Chip Detector" segment illuminated the chip detector panel is actuated down and the assembly that is grounded will illuminate in red the segment that corresponds to the grounded assembly. The illumination of the panel segment indicates a contaminated component which has sufficient metal chips on the detector plug to cause a closed circuit in the detector system.

**2-62. Oil Bypass Caution Light.** This caution segment XMSN OIL BYPASS is illuminated when the transmission oil system bypass valve is in the bypass position. When the light is illuminated the transmission oil is routed around the transmission oil cooler.

**2-63. Engine Oil Supply System.** The dry sump pressure type oil system is entirely automatic. The oil supply system's bypass electrical system is energized when the FUEL VALVE and OIL VALVE circuit breaker is energized.

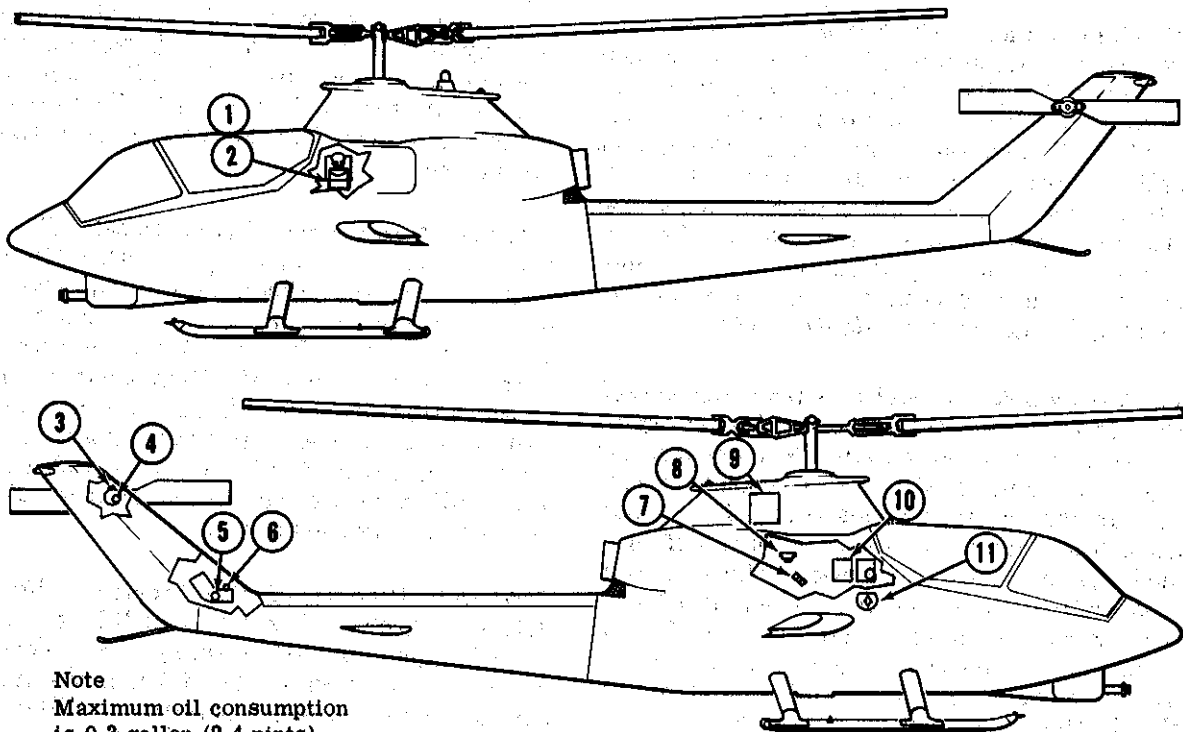

Note  
Maximum oil consumption  
is 0.3 gallon (2.4 pints)  
per hour

- |   |                                      |
|---|--------------------------------------|
| 1. Hydraulic Oil Level Sight Gages              | 7. Transmission Oil Level Sight Gage |
| 2. Hydraulic Oil Reservoir                      | 8. Transmission Oil Filler           |
| 3. Tail Rotor 90° Gear Box Oil Filler           | 9. Engine Oil Tank                   |
| 4. Tail Rotor 90° Gear Box Oil Level Sight Gage | 10. Hydraulic Oil Reservoir          |
| 5. Tail Rotor 42° Gear Box Oil Level Sight Gage | 11. Fuel Filler                      |
| 6. Tail Rotor 42° Gear Box Oil Filler           |                                      |

**SPECIFICATIONS AND CAPACITIES**

**ENGINE FUEL - MIL-J-5624 Grade JP-4**  
Capacity 247 U.S. Gals.

**ENGINE OIL - MIL-L-7808**  
Capacity 2.75 U.S. Gals.

**TRANSMISSION OIL - MIL-L-7808**  
Capacity 2.25 U.S. Gals.

**TAIL ROTOR INTERMEDIATE GEAR BOX OIL**  
MIL-L-7808 Capacity 0.375 U.S. Pints

**TAIL ROTOR GEAR BOX OIL - MIL-L-7808**  
Capacity 0.50 U.S. Pints

**HYDRAULIC FLUID - MIL-H-5606**  
System Capacity (each) - 10.0 U.S. Pints  
Reservoir Capacity (each) - 3.2 U.S. Pints  
Refill Capacity (each) - 2.1 U.S. Pints

209478-2-1D

**Figure 2-13. Servicing diagram (Sheet 1 of 2)**

ARMY STANDARD FUEL

Wide Cut Type Fuels (JP-4 Type). Any of the following may be used as Army Standard Fuel when JP-4 is not available.

AIR 3407A	France	DSM-70E	Belgium
AM-C-142f	Italy	F-40	NATO
ASTM Type B	U.S. Commercial	MIL-J-5161, Grade 1 (JP-4 Referee)	United States
D. Eng. R.D. 2486 Iss. 3AM 1	Denmark	VTL-9130-006	West Germany
D. Eng. R.D. 2486 Iss. 3AM 1	Norway	3-GP-22d	Canada
D. Eng. K.D. 2486 Iss. 3AM 1	United Kingdom		

ALTERNATE FUEL

Alternate fuels specified for use are JP-5 (MIL-T-5624) and MIL-F-46005 (CITE) fuel. Any of the following may be used as alternate fuel when JP-5 is not available.

a. Military Fuel (Freezing Point - 40°F (-40°C).

AIR 3405	France	MIL-F-25558, RJ-1	United States
AM-C-141C	Italy	MIL-R-25576, RP-1	United States
D. Eng. R.D. 2482 Iss. 3	Britain	MIL-T-5624, JP-5	United States
D. Eng. R.D. 2488 Iss. 2	Britain	MIL-J-5161, Grade II, JP-5	United States
F-30	NATO		

b. Military Fuel (Freezing Point - 55°F (-48°C)

AIR 3404A	France	MIL-F-25524, JP-6 Referee	United States
D. Eng. R.D. 2488 Iss. 3	Britain	MIL-F-25656, JP-6	United States
D. Eng. R.D. 2488 Iss. 3	Netherlands	MIL-T-5624, JP-5	United States
D. Eng. R.D. 2494 Iss. 1	Britain	VTL-9130-007	West Germany
F-34	NATO	3-GP-23d	Canada
F-42	NATO	3-GP-24e	Canada

c. Commercial Fuel (ASTM D1655, Type A) (Freezing Point -40°F (-40°C).

AVTUR - 40	Shell 640
Esso Turbo Fuel 1-B	Texaco Code No. 406 Turbine Fuel K-40
GULFLITE Turbine Fuel A	

d. Commercial Fuel (ASTM D1655, Type A-1) (Freezing Point -55°F (-48°C).

Atlantic Refining Company Turbine Fuel	Esso Turbo Fuel 5
AVTUR - 50	GULFLITE Turbine Fuel A
Esso Turbo Fuel 1-A	Shell 650

The following EMERGENCY fuel may be used in accordance with Technical Bulletin TB AVN 2:

Gasoline, ALL types (limited to 10 hours accumulated times between internal inspection).

An entry shall be made in DA Form 2408 after the use of EMERGENCY fuels.

209478-2-2A



(Deleted)

The oil system consists of an oil tank with de-aeration provisions, a thermostatically controlled oil cooler with bypass valve, pressure transmitter and indicator, low pressure warning switch and indicator, oil supply return, vent and breather lines and automatic manual emergency oil cooler bypass system (see figure 2-16). The connecting lines include, where necessary, quick-disconnect fittings to allow rapid removal of the engine. A drain valve has been provided for the oil tank. Pressure for engine lubrication and scavenging of return oil is provided by the engine mounted and driven oil pump. The tank capacity, oil specification and grade are shown on the Servicing Diagram (see figure 2-13).

**2-64. Oil Cooling.** Engine oil cooling is accomplished by an oil cooler with thermostatic valves and bypass provisions. The cooler is located in the engine support deck below the engine combustor. Air for cooling is supplied by the tail rotor drive shaft fan. The fan is powered at all times the engine is in operation and no control is required or provided.

**2-65. Oil System Control.** The emergency oil bypass system is controlled by the low level switch in the oil tank and the ENG OIL BYP switch in the Engine Control Panel (see figure 2-7). When the ENG OIL BYP switch is in AUTO position the low level switch in the oil tank will automatically energize the two position bypass valve circuit when the engine oil tank

supply is at approximately one gallon. When the bypass valve is activated the oil bypasses the oil cooler. With the ENG OIL BYP switch in the OFF position the bypass circuit is deactivated.

**2-66. Fuel Supply System.** The helicopter fuel system (see figure 2-17) consists of two interconnected rubber fuel cells, each with a sump and a submerged fuel boost pump, a fuel pressure switch, a capacitor-type fuel quantity gage system and a fuel-low level warning switch; also included in the system are a fuel filter, a motor shut-off valve, a fuel pressure transmitter and gage, caution lights for ENGINE FUEL PUMP, 10% FUEL, FWD BOOST and AFT FUEL BOOST, FUEL FILTER, drain valves and defuel valves. The gunner's caution lights are FUEL FILTER, 10% FUEL, and ENGINE FUEL PUMP.

**Note**

The 10% fuel caution light is valid with either fuel pump inoperative.

**2-67. Fuel System Control.** The fuel system is controlled by the FUEL switch.

**2-68. Fuel Switch.** The fuel switch (see figure 2-7) is a two-position switch and is located on

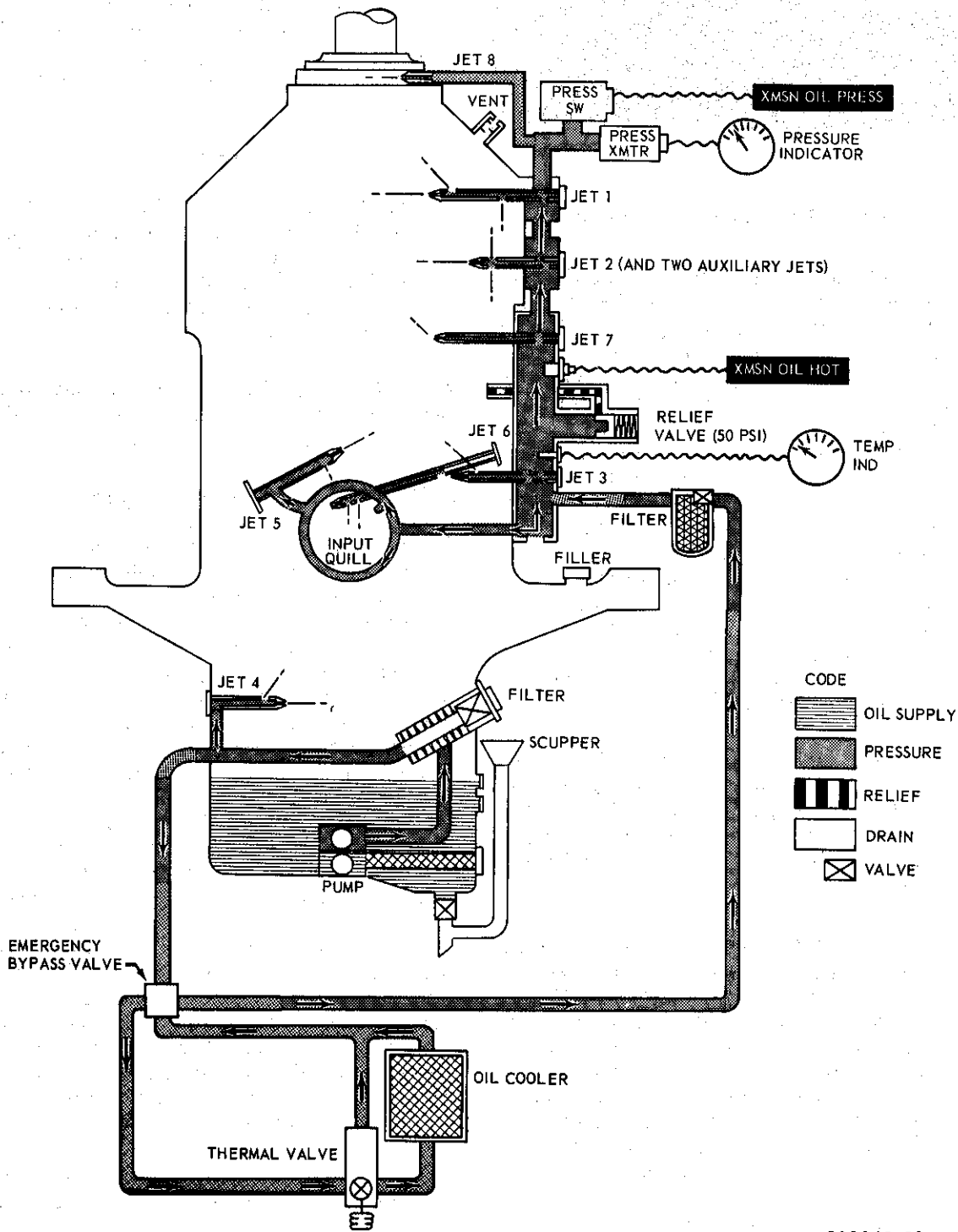

209040-1A

Figure 2-14. Transmission oil system schematic

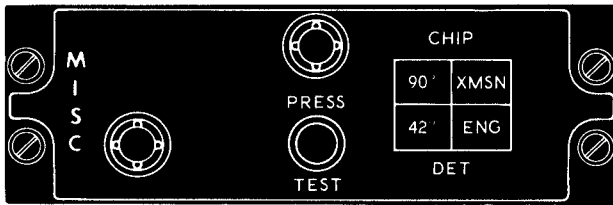

209075-8

Figure 2-15. Miscellaneous control panel

the pilot's left console just forward of the collective stick. The switch is protected against accidental operation by a spring-loaded toggle lever which must be pulled up before switch movement can be accomplished. Movement of the switch to the forward position (ON) activates the forward and aft boost pumps, opens the fuel shut-off valve and opens the oil valve. When the toggle head is lifted and the switch is moved to aft position, the fuel flow is terminated and the forward and aft fuel boost pumps cease operation. The electrical power for the valve and forward boost pump is supplied from the 28 volt dc essential bus. Electrical power for the aft boost pump is supplied by the non-essential bus. Circuit protection is provided by circuit breakers on the dc circuit breaker panel (see figure 2-12).

**2-69. Fuel System Indicators.** The pilot's fuel system indicators consist of FWD FUEL BOOST, AFT FUEL BOOST, and FUEL FILTER caution lights. The gunner's indicators consist of ENGINE FUEL PUMP and FUEL FILTER caution lights.

**2-70. Forward and Aft Fuel Boost Pump Caution Lights.** The caution panel worded segment "FWD FUEL BOOST" and "AFT FUEL BOOST" is located in the pilot's caution panel (see figure 2-12). A failure of a fuel boost pump is sensed by a pressure switch which then illuminates the caution light for the particular boost pump (FWD or AFT) that failed. The caution lights and pressure switches are powered by the 28 volt dc essential bus.

**2-71. Fuel Filter Caution Light.** The caution panel worded segments "FUEL FILTER" are located in the pilot's caution panel (1, figure 2-12) and the gunner's caution panel (see figure 2-11). A differential pressure switch is mounted in the fuel line across the filter. When the filter be-

comes partially obstructed, the pressure switch senses this and closes contacts, to energize the circuit. The FUEL FILTER caution light illuminates, alerting the pilot of a clogged fuel filter condition. If clogging continues, the fuel bypass valve opens to permit fuel to flow around the filter.

**Caution**

Within 30 minutes after the FUEL FILTER caution light illuminates, the pilot shall land the helicopter. The helicopter shall not be flown until the reason for illumination has been determined and corrected.

**2-72. Electrical Power Supply Systems.** The electrical power systems consist of a dc and an ac system (see figure 2-18).

**2-73. DC Power Supply System.** The 28 volt direct current supply system is a signal conductor system with the negative lead of the generator grounded to the helicopter structure. Direct current power is supplied by the starter-generator, battery or external power. The power supply incorporates a primary bus, essential bus, non-essential bus, generator voltage regulator, generator field relay, generator reverse current relay, bus control relay, battery relay, non-essential bus relay, starter relay, external power relay, control panel and circuit breakers to furnish protection for the system and equipment operating from the system. In the event of a main generator failure, the non-essential bus is automatically dropped. The circuit is opened by means of the bus control relay and the non-essential bus relay actions; however, a switch has been provided (NON-ESS BUS) to override the automatic action. The 28 volt starter-generator is rated at 300 ampere output and is mounted on and driven by the engine accessory drive section. Direct current power control is accomplished from the pilot's right consoles Electrical Power and Lights Control Panel, (see figure 2-19).

**2-74. DC Power Control.** The dc power is controlled by the battery switch, generator switch, non-essential bus switch and dc circuit breakers.

**2-75. Control Panel.** This panel, Electrical Power and Lights Control Panel, is located on the pilot's console. The panel contains the following

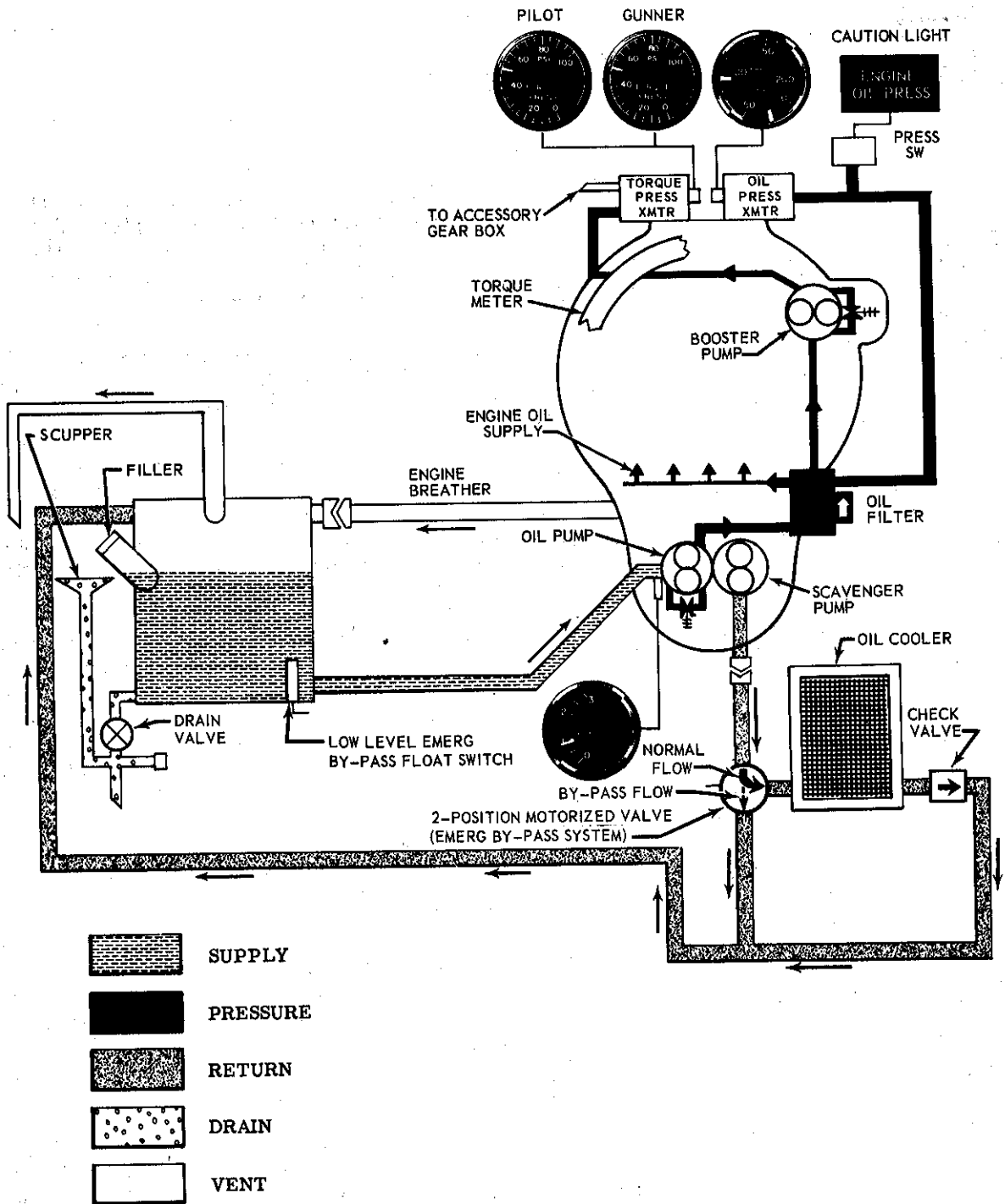

209060-2A

Figure 2-16. Engine oil system schematic

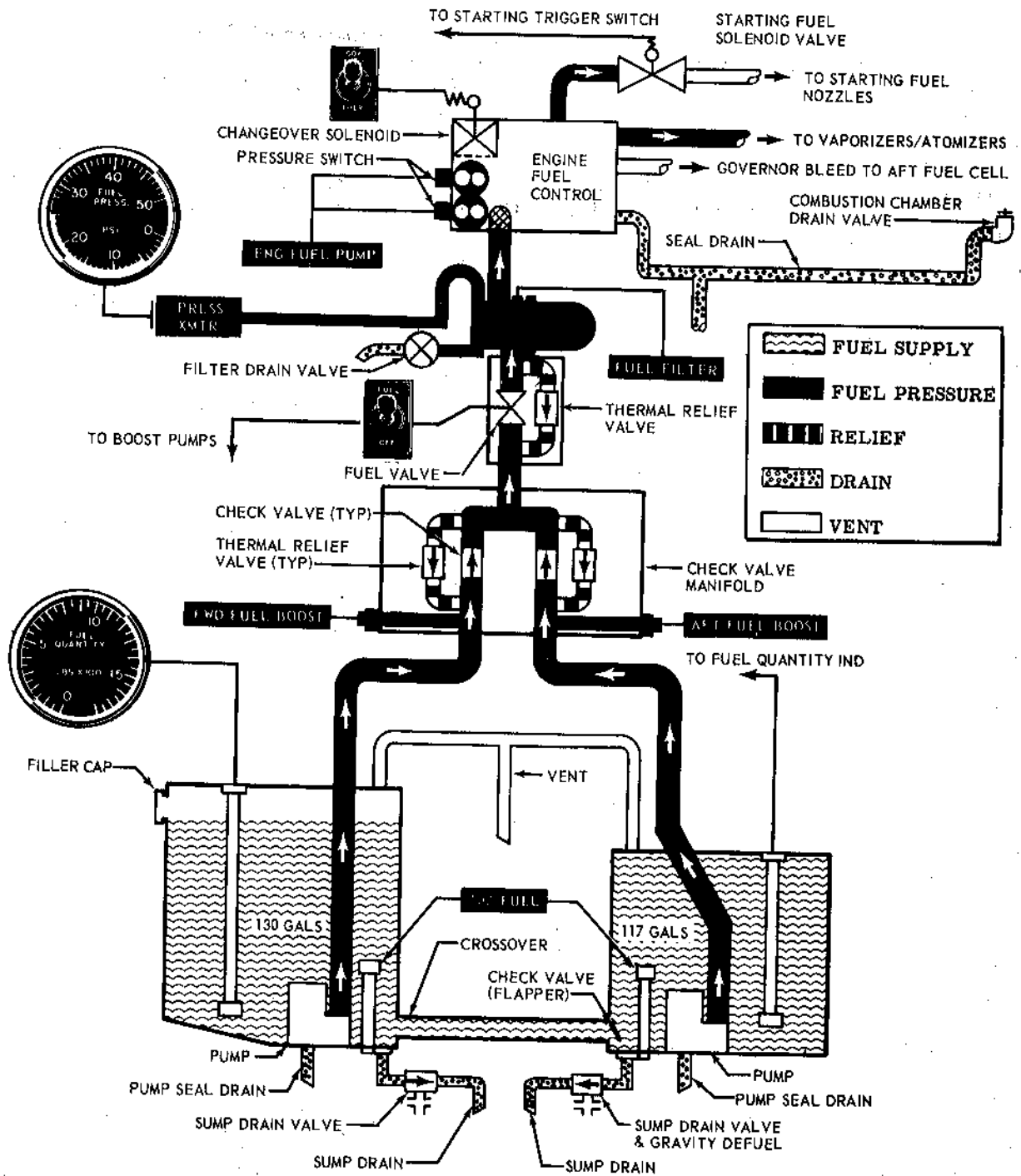

209068-1B

Figure 2-17. Fuel system schematic

dc control switches: BAT, GEN, INV., and NON-ESS BUS. Panel illumination is provided by two panel lights that are controllable from the CONSOLE rheostat switch.

**2-76. Battery Switch.** This switch is located in the left area of the panel and is a two-position toggle switch, labeled BAT. Battery electrical power is supplied to the helicopter's electrical system when the switch is in the forward position. When the switch is placed in the forward position, it closes the circuit to the actuating coil of the battery relay and 28 volt dc is then being delivered from the battery to the primary bus. When the switch is placed in the aft position it opens the circuit to the actuating coil of the battery relay and no current is delivered from the battery to the primary bus. The gunner is provided an ELEC PWR-EMER off switch in his miscellaneous control panel (see figure 2-20) to provide the gunner a means of de-energizing the electrical system.

**2-77. Generator Switch.** This switch is located in the top center area of the electrical power and lights panel and is a three position switch. This switch is labeled GEN in the forward position, OFF in center position and RESET in aft position. The RESET position is spring loaded to return to OFF position when released; therefore, to reset generator the switch must be held in the RESET position momentarily and then moved to the forward position.

**2-78. Inverter Switch.** This switch is located in the right forward area of the control panel and is a two-position toggle switch labeled INV. AC electrical power is provided to the electrical system when the switch is in the forward position. The inverter's power is supplied by the non-essential bus; therefore, to have ac power, electrical power must be available at the non-essential bus. When the switch is in the "OFF" position it opens the circuit to the actuating coil of the inverter relay. When the switch is in the STBY position the static inverter will supply the ac current and derives its power from the dc essential bus.

**2-79. Non-Essential Bus Switch.** This switch is located in the forward right area of the panel. This switch is a two-position switch labeled NON-ESS BUS. When the switch is in the forward position power is supplied to the non-essential bus provided the generator is operating and charging. When the switch is in the

aft position (MANUAL), power is supplied to the non-essential bus regardless of the generator operation. In all normal operations the switch should be in the forward position.

**2-80. Circuit Breaker Panel.** The dc circuit breaker panel (figure 2-21) is located in the aft section of the pilot's right console and is in easy reach of the pilot. Each individual circuit breaker is clearly labeled for the particular electrical circuit protected. In event a circuit is overloaded the circuit breaker protecting that particular circuit will pop out. The circuit is reactivated by pushing the circuit breaker button in.

**2-81. DC System Indicator.** The dc indicator consists of the volt-ammeter.

**2-82. DC Volt-Ammeter.** The direct current volt-ammeter (see figure 2-10) is mounted in the center right area of the instrument panel and is a dual purpose instrument. The lower scale on the face of the instrument dial is calibrated in volts and the top scale on the instrument dial is calibrated in amps. The instrument has dual hands and amperage and voltage is displayed simultaneously. On helicopter serial number 66-15248 and subsequent the direct current volt-ammeter (see figure 2-10) is mounted in the center right area of the instrument panel and is a dual purpose instrument. The right scale on the face of the instrument is calibrated in volts and the left scale on the instrument dial is calibrated in amps. The instrument has dual hands and amperage and voltage are displayed simultaneously.

**2-83. AC Power Supply System.** The alternating current is supplied by one 100 va, single phase inverter that converts the 28 volt dc to 115 volts ac. The inverter is controlled by the INV switch on the Electrical Power and Lights Control Panel (see figure 2-19). The inverter supplies 115 volt ac to the SAS system, fuel quantity, gyro compass, attitude indicator, ac fail relay and 26 volt transformer. The 26 volt ac transformer in turn supplies ac to the following: fuel pressure, engine oil pressure, transmission oil pressure, torque pressure and heading indicator. A caution panel worded segment "INST INVERTER" will illuminate when ac power is lost.

**2-84. AC Power Control.** The ac power is controlled by the inverter switch and ac circuit breakers.

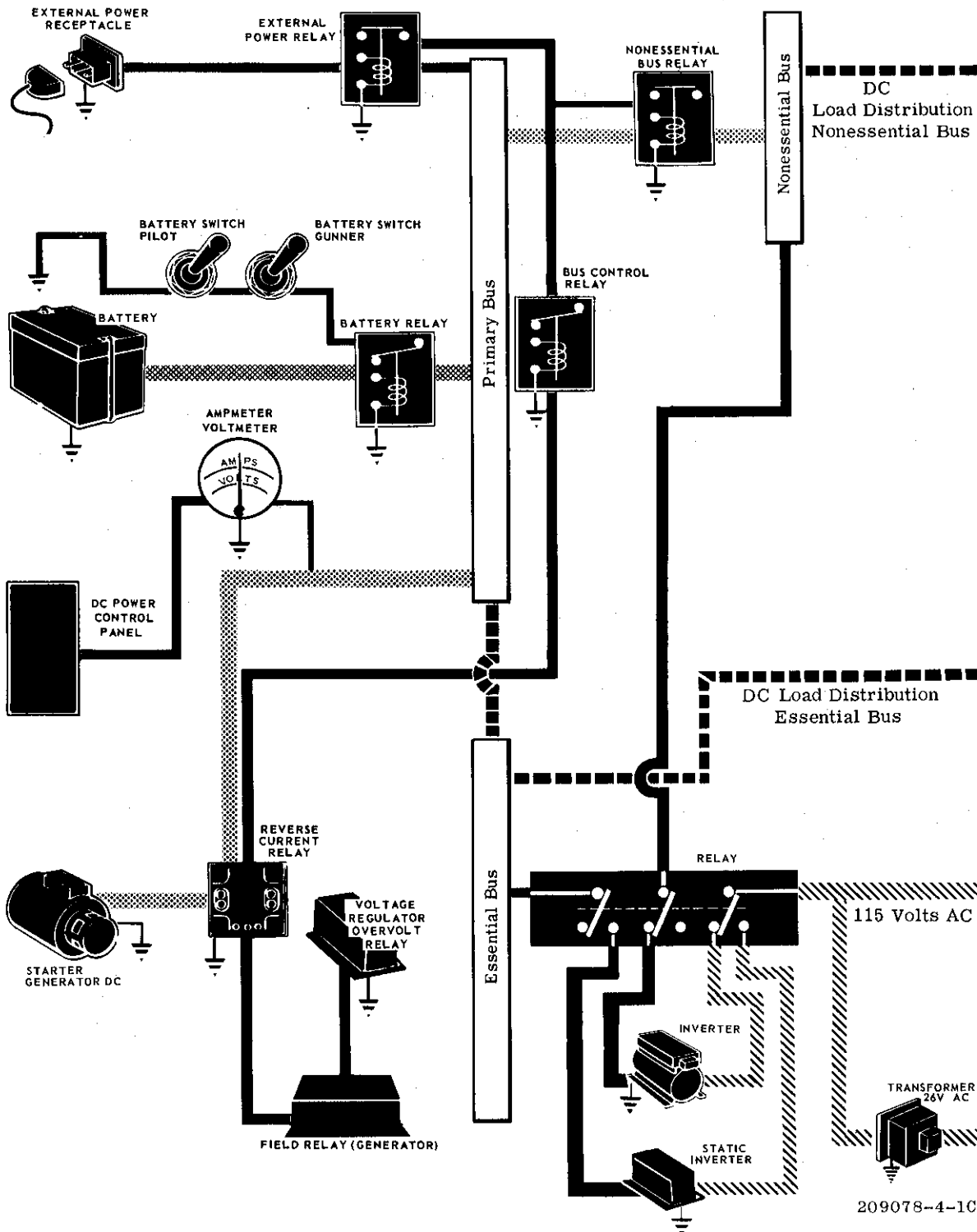

209078-4-1C

Figure 2-18. Electrical system schematic (Sheet 1 of 2)

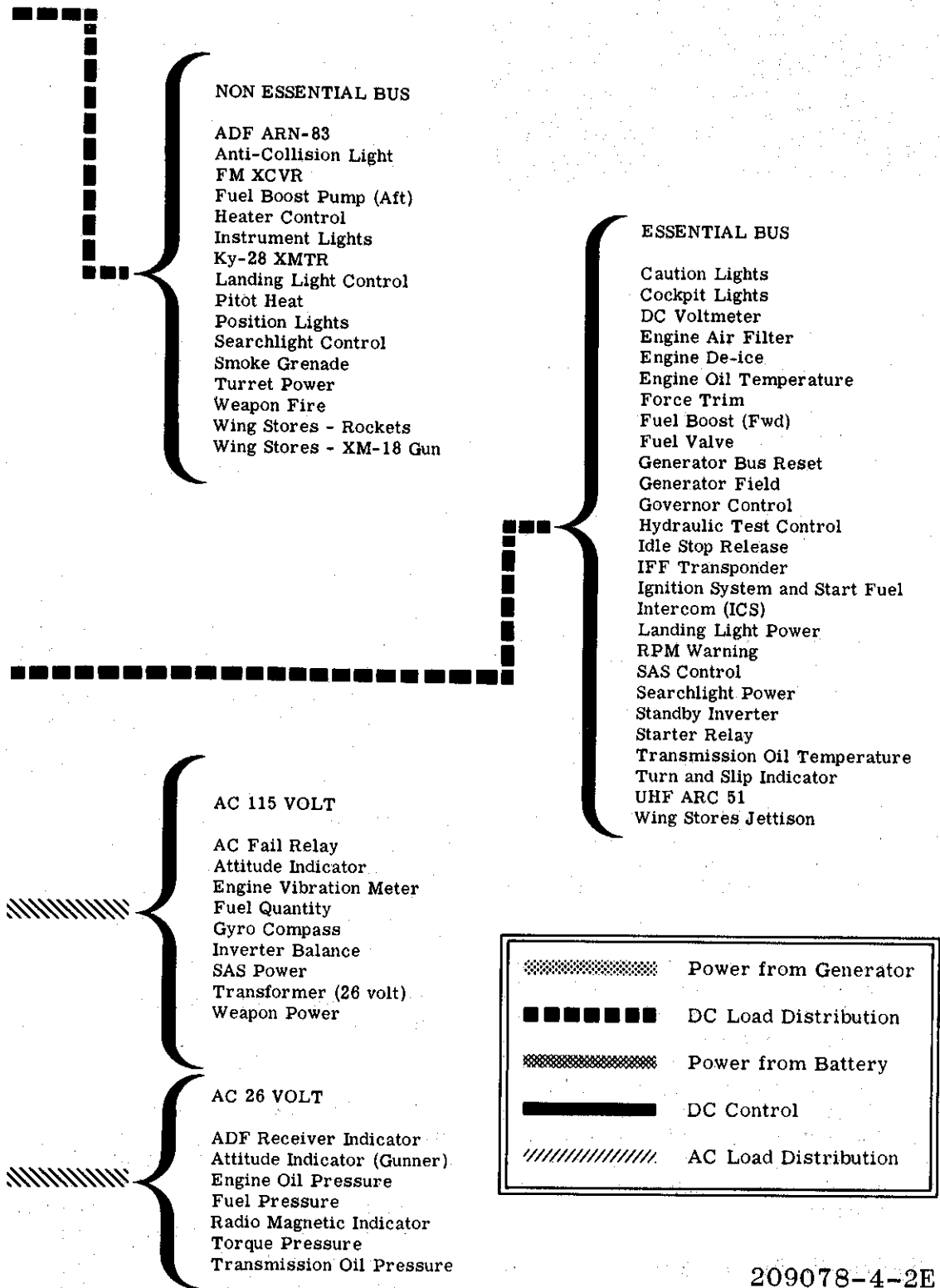

209078-4-2E

Figure 2-18. Electrical system schematic (Sheet 2 of 2)



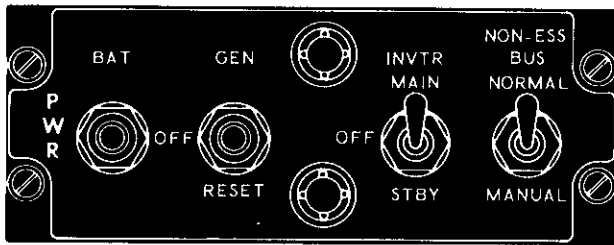

2 09075-7

Figure 2-19. Electrical power control panel

**2-85. Inverter Switch.** The inverter switch is located on the Electrical Power and Lights Control Panel (see figure 2-19) and is a toggle type switch. The forward position is ON, center position off and aft position energizes the standby inverter. For normal flight the inverter switch is kept in the forward position. The inverter circuit is powered from the non-essential bus and the standby inverter is powered by the essential bus. The circuit is protected by the inverter power circuit breakers.

**2-86. AC Circuit Breakers.** The ac circuit breakers are located in the ac circuit breaker panel (see figure 2-22). In the event of a circuit overload, the circuit breaker protecting that particular circuit will pop out. The circuit is reactivated by pushing the circuit breaker button in.

**2-87. AC System Indicator.** The caution panel worded segment "INST INVERTER" is located in the pilot's caution panel. The caution panel segment is illuminated if ac power to the system is lost.

**2-88. External Power Receptacle.** The external power receptacle is located on the aft left side of the fuselage. When a 28 volt dc auxiliary power unit plug is securely inserted in the receptacle the external power relay in the helicopter's electrical system is energized and 28 volt dc electrical power is supplied to the primary bus for distribution. When the external door is opened the EXTERNAL POWER worded segment in the master caution panel will be illuminated.

**2-89. Hydraulic Power Supply System.** A dual hydraulic control system (see figure 2-23) is provided for the cyclic and collective controls with the directional controls powered by a single servo cylinder. The hydraulic system

consists of two variable delivery hydraulic pumps, two reservoirs, relief valves, shut-off valves, pressure warning lights, lines, fittings, and manual dual tandem servo actuators incorporating irreversible valves. Tandem power cylinders incorporating closed center four-way manual servo valves and irreversible valves are provided in the lateral and fore-and-aft cyclic and collective control systems. A single power cylinder incorporating a closed center four-way manual servo valve is provided in the directional control system. The cylinders contain a straight-through mechanical linkage. Each hydraulic system contains a modular component assembly consisting of pressure line filter, return line filter, relief valve, pressure switch, differential pressure indicators and an electrically operated bypass valve.

**2-90. Hydraulic System Control.** The hydraulic system is controlled by the hydraulic control test switch.

**2-91. System Test Switch.** The hydraulic system test switch is located on the pilot's left console and is in the Engine Control Panel (see figure 2-7). The switch is a three-position toggle type switch labeled HYD TEST SYS 1 and SYS 2, and is spring loaded to the center position. When the switch is actuated and held in either SYS 1 or SYS 2 the hydraulic system's solenoid valve port opens and hydraulic fluid bypasses from the pump to the reservoir, thus no pressure is applied to the servo of the tested system. Electrical power for the hydraulic system control is supplied from the 28 volt dc essential bus and circuit is protected by a circuit breaker on the dc circuit breaker panel (see figure 2-21).

**2-92. Hydraulic System Indicators.** The hydraulic indicators consist of fluid level gages and low pressure caution lights.

**2-93. Fluid Level Gages.** The hydraulic reservoirs are mounted just aft of the crew compartment and have a capacity of four pints. A sight gage is mounted on the center area of each reservoir and both gages are visible from the left pylon access door. System number 1 reservoir is located on the left side and system number 2 reservoir is located on the right side.

**2-94. Low Pressure Caution Lights.** The caution panel worded segment "HYD PRESS NO. 1"

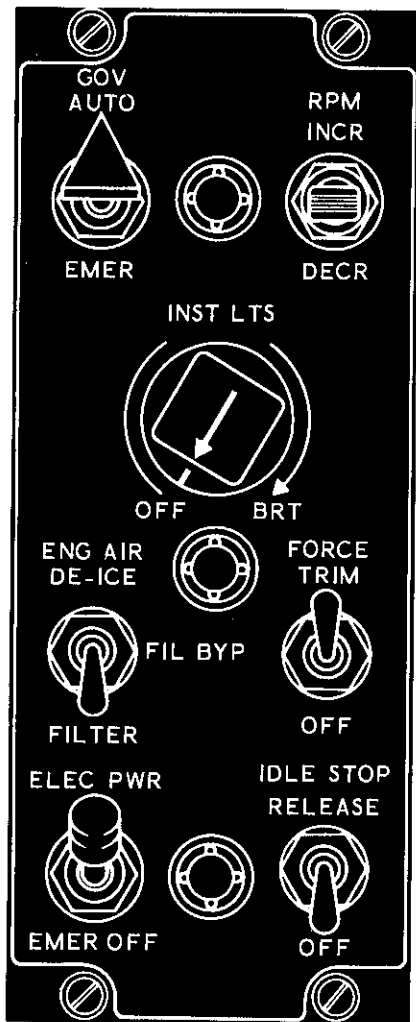

209075-5

Figure 2-20. Gunner's miscellaneous control panel

and "HYD PRESS NO. 2" are located in the pilot's and gunner's caution panel. The panels illuminate when the hydraulic system pressure is low. Electrical power for the hydraulic pressure caution indicator light is supplied from the 28 volt dc essential bus and circuit protection is provided by a circuit breaker on the circuit breaker panel.

**2-95. Secondary Hydraulic System.** The secondary hydraulic system (see figure 2-23) provides irreversibility in the cyclic control system and limited duration emergency power for the collective system. Should a condition arise where both systems No. 1 and No. 2 become inopera-

tive, the up-stream lock-out valve and spring loaded accumulator in conjunction with check valve located at inlet port of each cyclic cylinder provides partial pressurization of each cyclic cylinder. Up-stream of the collective cylinder, a pressurized lock-out valve, charged accumulator, pilot controlled electric solenoid valve and two check valves are provided and arranged to provide hydraulic oil stored at 1500 psi to the collective cylinder. During normal boost on operations, the accumulator is hydraulically charged by the number 1 system hydraulic pump. An electrical switch is provided to allow the pilot to conserve the stored hydraulic power.

**2-96. Flight Control System.** The flight control system (see figure 2-24) is a positive mechanical type, actuated by conventional helicopter controls which when moved, direct the helicopter in various modes of flight. Complete flight controls are provided for both pilot and gunner. The system includes; the cyclic control stick, used for fore and aft and lateral control; the collective pitch (main rotor) control lever, used for vertical control; tail rotor (directional) control pedals, used for heading control; and a synchronized elevator, to increase controllability and lengthen CG range. The control forces of the flight control system are reduced to a near zero pounds force, to lessen pilot fatigue, by hydraulic servo cylinders connected to the control system mechanical linkage and powered by the transmission driven pumps. Force trims (force gradient) connected to the cyclic and directional controls are electrically operated mechanical units; used to induce artificial control feeling into the cyclic and directional controls and to prevent the cyclic stick and directional controls from moving of their own accord.

**2-97. Force Trims (Force Gradient).** Force gradient devices are incorporated in the cyclic control and directional pedal controls. These devices are installed in the flight control system between the cyclic stick and the hydraulic power cylinders, and between the directional pedals and the hydraulic power cylinder. The devices act to furnish a force gradient or "feel" to the cyclic control stick and directional control pedals, however, these forces can be reduced to zero by depressing the left button (see figure 2-8) on top of the cyclic control stick. The gradient is accomplished by means of springs and magnetic brake release assemblies which

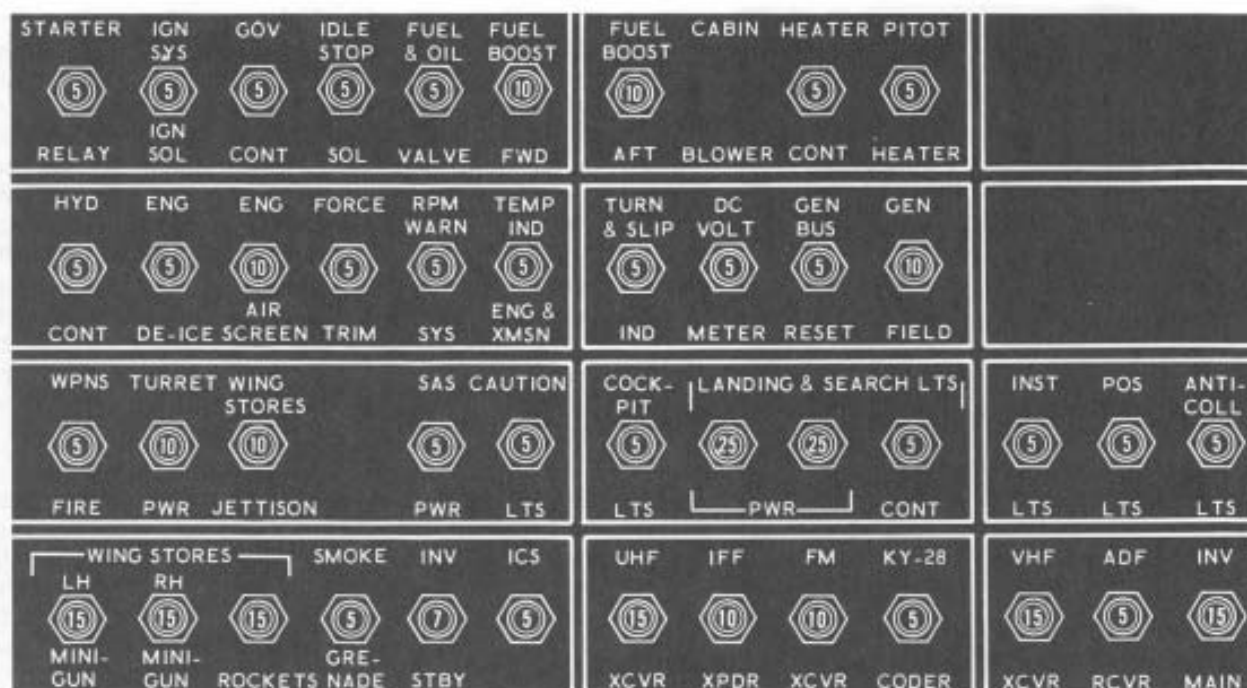

2-09075-11 A

Figure 2-21. DC circuit breaker panel

enable the pilot to trim the controls, as desired, for any condition of flight. A force trim toggle type switch is installed in the engine control panel (see figure 2-7) to activate the force trim system. The force trim units provide the pilot with a 100 percent trim authority.

**2-98. Crew Compartment Controls.** The pilot's controls are of the conventional helicopter controls. The gunner's cyclic and collective controls are side arm controls that are operated with less motion than the pilot's controls.

**2-99. Cyclic Control Stick.** The pilot's cyclic stick grip contains a two-position trigger switch for the turreted gun, radio two-position switch, force trim switch, SAS release switch and a switch for firing the wing mounted weapons (see figure 2-8). The gunner's cyclic stick grip contains a two-position trigger switch for guns, force trim switch, two position radio switch, SAS release switch and wing stores firing switch. The pilot's cyclic stick has a built-in operating friction. The cyclic control movements are not mixed, but are transmitted directly to the swashplate. The fore and aft

cyclic control linkage is routed from the cyclic stick through the SAS actuator, the dual boost hydraulic actuator to the right horn of the fixed swashplate ring. The lateral is similarly routed to the left horn. Control "feel" is provided by the force trim units.

**2-100. Collective Pitch Control Lever.** The pilot's collective pitch control lever (see figure 2-8) is located to the left of the pilot's position and controls the vertical mode of flight. Desired operating friction can be induced into the control lever by hand tightening the friction adjuster. A rotating grip-type throttle and a switch box assembly are located in the upper end of the pilot's collective pitch lever. The switch box assembly contains the starter, governor, engine idle release, landing light switches and search light switches. A spring loaded pitch lever down lock is located on the console at the approximate center of the lever. The gunner's collective stick is located on the gunner's left console and is operated with wrist motion. No switches are installed on the gunner's collective control.

**Note**

The collective pitch control system has a built-in friction of 8 to 10 pounds with MANUAL friction control in full decrease position.

**2-101. Tail Rotor Pitch Control Pedals.** Tail rotor pitch control pedals alter the pitch of the tail rotor blades and there-by provide the means of directional control. Pedal adjusters are located at the base of the pedals at the floor level. Adjusters knobs (see figure 2-8) enable adjustment of pedal distance for individual comfort. The force trim system is connected to the directional controls and is operated by the force trim switch on the cyclic control stick grip. The gunner is provided with a force gradient ON-OFF switch. Heel rests are provided for the gunner to preclude inadvertent operation of the control pedals during maneuvering flight when the pilot is in control of the aircraft.

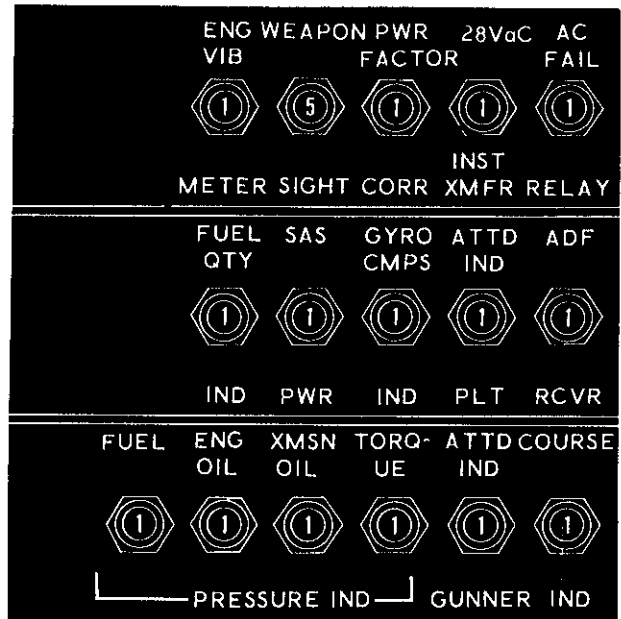

209075-12

Figure 2-22. AC circuit breaker panel

**2-102. Stability Augmentation System (SAS).**

The SAS is a three axis stability and control augmentation system. It is integrated into the fore and aft, lateral and directional flight controls to improve the stability and handling qualities of the helicopter. The system provides a highly dampened airframe for external disturbances, yet maintains high quality control/response characteristics for pilot inputs. The compensating control motions are produced by electro-hydraulic servo actuators installed as a series extensible link in the appropriate flight controls. The servo actuator movements are not felt in the pilot's controls. The actuators are limited to 25 percent authority and will center and lock in case of electrical and/or hydraulic failure. The pilot's control panel is located in the left console and includes "NO GO" warning lights. Both pilot and gunner have emergency SAS disengage switches on the cyclic stick grips (see figure 2-8 and 2-9).

**2-103. Synchronized Elevator.** The synchronized elevator (see figure 2-1) is located near the aft end of the tail boom and is connected by control tubes and mechanical linkage to the fore and aft cyclic control system. Fore and aft movements of the cyclic control stick produces a change in the synchronized elevator attitude, thus increasing controllability and CG range.

**2-104. Landing Gear System.** The landing gear system is a skid type, consisting of two lateral mounted arched cross-tubes attached to two formed longitudinal skid tubes. The landing gear structural members are made from formed aluminum alloy tubing with full length steel skid shoes to minimize skid wear. The gear assembly is attached with clamps at four points to the fuselage structure; therefore, gear removal for maintenance can easily be accomplished. The manually retractable and quickly removable wheel assemblies have been provided to facilitate helicopter ground handling operations.

**2-105. Tail Skid.** A tubular steel tail skid is attached to the lower aft section of the tail boom assembly and acts as a warning to the pilot upon an inadvertent tail low landing.

**2-106. Flight Instruments.** The pilot's flight instruments consist of airspeed indicator, turn and slip indicator, vertical velocity indicator, altimeter, and attitude indicator. The gunner's flight instruments consist of an airspeed indicator, attitude indicator, and altimeter.

**2-107. Airspeed Indicator.** The single scale airspeed indicator (see figures 2-10 and 2-11) is

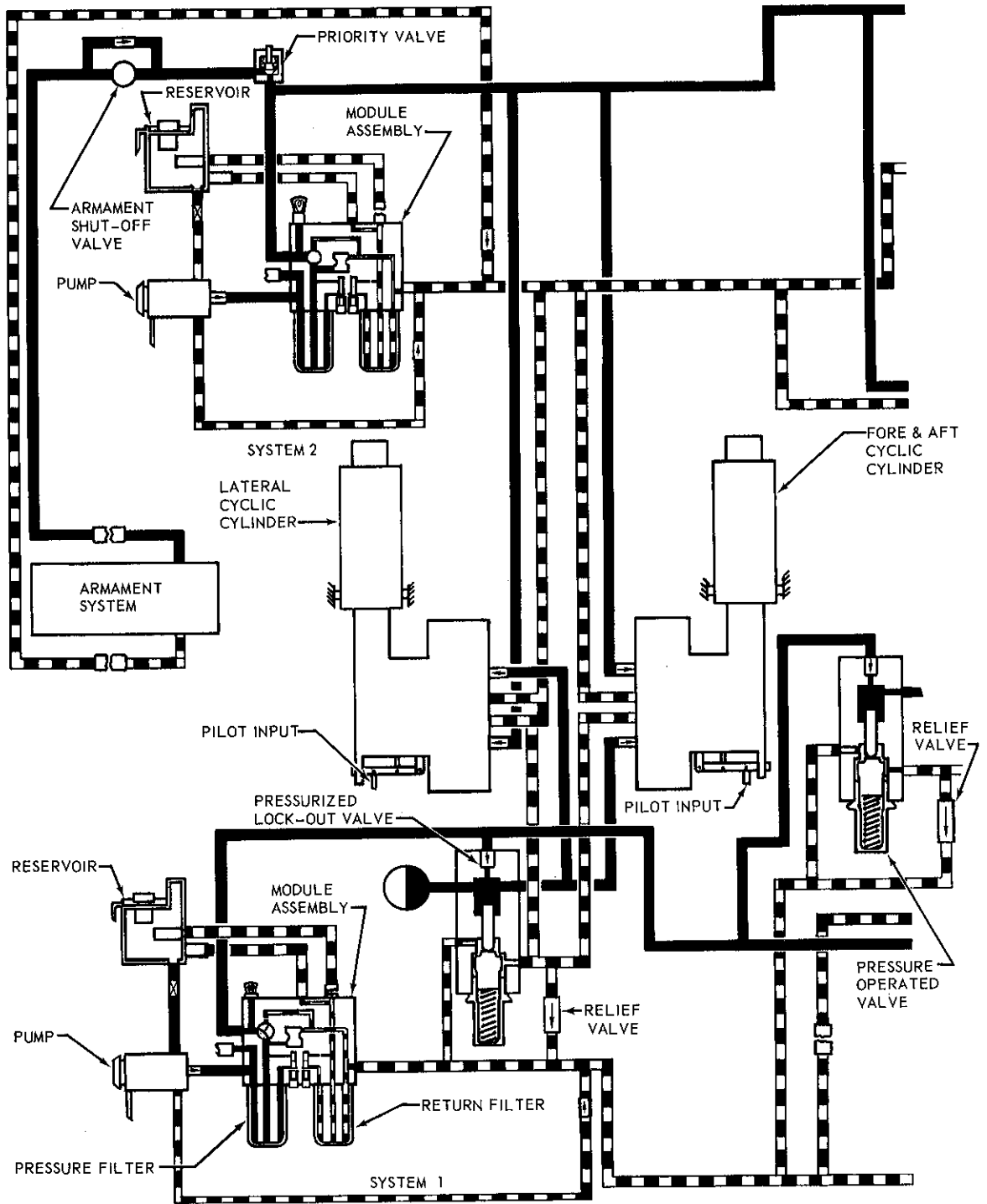

209476-2-1B

Figure 2-23. Hydraulic system schematic (Sheet 1 of 2)

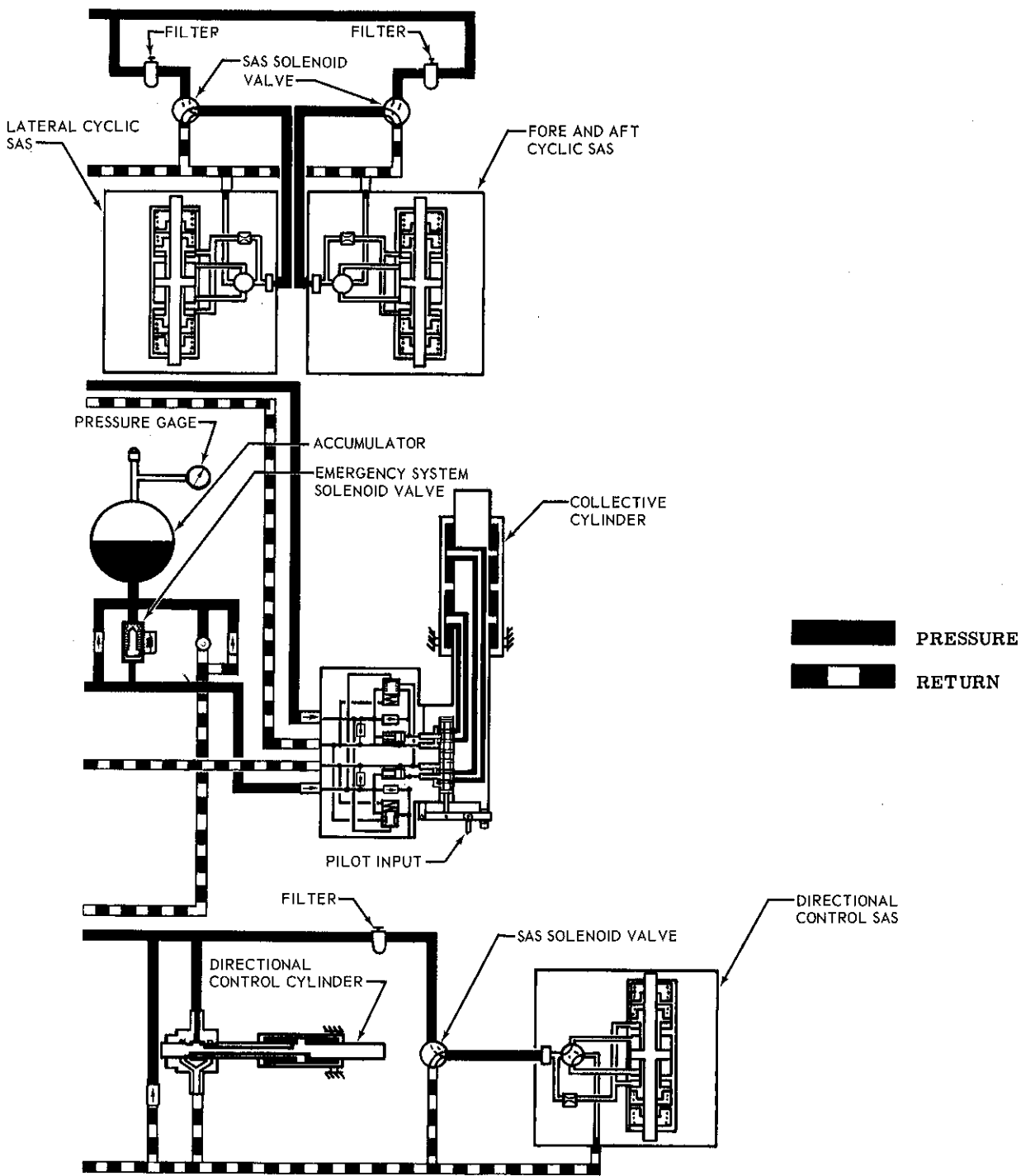

209476-2-2A

Figure 2-23. Hydraulic system schematic (Sheet 2 of 2)

calibrated in knots and provides an indicated airspeed of the helicopter at any time during flight, by measuring the difference between impact air pressure from the pitot tube and static air pressure from the static vents. The pitot tube is mounted on the nose section, and the static vents are located in the side cabin skins near the bottom edge of the canopy and just aft of the gunner's compartment.

**2-108. Turn and Slip Indicator.** The turn and slip indicator (4 MIN TURN) (see figure 2-10) is controlled by an electrically activated gyro which is dc powered from the essential bus. The instrument has a needle (turn indicator) and a ball (slip indicator). Although the needle and ball are combined in the one instrument and are normally read and interpreted together, each has its own specific function and operates independently of the other. The ball indicates when the helicopter is in a condition of zero slip, either in a turn or in straight and level flight. In the event of helicopter yawing or slipping the ball will be off center. The needle indicates in which direction and what rate the helicopter is turning. The electrical circuit is protected by a circuit breaker on the dc circuit breaker panel.

**2-109. Vertical Velocity Indicator.** The vertical velocity indicator (Rate of Climb) (See figure 2-10) registers ascent and descent of the helicopter in feet per minute. The instrument is actuated by the rate of atmospheric pressure change and vented to the static air system.

**2-110. Altimeter.** The altimeter (ALT) furnishes direct readings of height above sea level and is actuated by the pitot static system.

**2-111. Pilot's Attitude Indicator.** The pilot's attitude indicator (see figure 2-10) is located in the top area of the instrument panel and provides the pilot with a visual indication of the pitch and roll flight attitude of the helicopter in relation to the earth's horizontal plane. The attitude indicator system is operated by single phase, 115 volt, ac power supplied by the inverter, and is protected by circuit breakers on the ac circuit breaker panel (see figure 2-22). Integral lighting, operated by 28 volt dc from the essential bus, is incorporated in the indicator. An OFF warning flag in the indicator is exposed when electrical power is removed from the system however, the OFF flag does not indicate internal system failure which may

occur in the control or indicator. The flag disappears approximately two minutes after electrical power is supplied in the control. The horizon is represented as a white line and bank (roll) angles are read from the semi-circular scale located on the upper half of the indicator face. The pitch trim knob, located on the lower center area of the indicator, is adjusted to center the wings on the miniature airplane with the indicator sphere, with regard to the normal flight attitude of the helicopter.

**2-112. Gunner's Attitude Indicator.** The gunner's attitude indicator (see figure 2-11) is located in the top center area of the instrument panel. The instrument provides the gunner with a visual indication of the pitch and roll flight attitude of the helicopter in relation to the earth's horizontal plane. The indicator is powered by the 26 volt ac system. The indicator obtains its information from the pilot's attitude indicator. The pitch trim knob, located on the lower center area of the indicator, is adjusted to center the wings on the miniature airplane with the horizon on the indicator sphere with regard to the normal flight attitude of the helicopter. An inclinometer is located in the lower area of the attitude indicator.

**2-113. Navigation Instruments.** The stand-by compass data is carried in this chapter and instruments with avionics systems are covered in Chapter 5.

**2-114. Stand-by Compass.** A standard magnetic type compass (see figure 2-9) is mounted on the left windshield support. The compass is utilized by both the pilot and gunner.

**2-115. Miscellaneous Instruments and Indicators.** Instruments and indicators that are independent or are linked with more than one system are free air temperature indicator, master caution system and rpm high-low limit warning system.

**2-116. Free Air Temperature Indicator.** The bi-metal free air temperature indicator is located in the left side of the pilot's compartment just below the plexiglass canopy attachment edge. The indicator provides a direct reading of the outside air temperature.

**2-117. Pilot's Master Caution System.** The pilot's master caution system is a segment

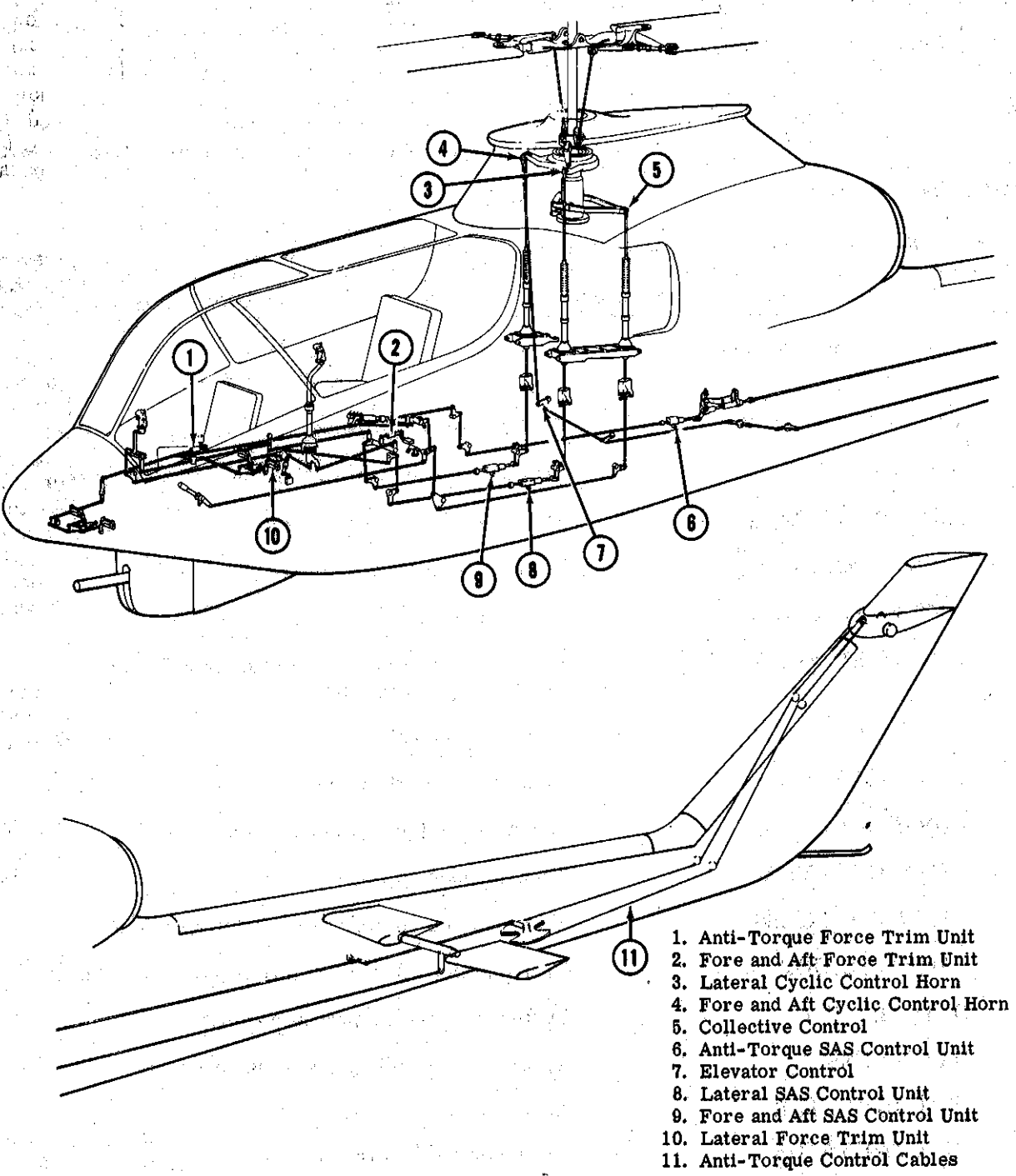

- 1. Anti-Torque Force Trim Unit
- 2. Fore and Aft Force Trim Unit
- 3. Lateral Cyclic Control Horn
- 4. Fore and Aft Cyclic Control Horn
- 5. Collective Control
- 6. Anti-Torque SAS Control Unit
- 7. Elevator Control
- 8. Lateral SAS Control Unit
- 9. Fore and Aft SAS Control Unit
- 10. Lateral Force Trim Unit
- 11. Anti-Torque Control Cables

209001-1A

Figure 2-24. Flight control system



wording type, consisting of a segmented word warning CAUTION panel. The caution system also has a remote master caution indicator light.

**2-118. Master Caution Indicator.** The pilot's master caution indicator light (see figure 2-10) is located in the top area of the instrument panel. When the light illuminates it will be aviation yellow and the pilot is alerted to check the caution panel for the fault condition or conditions that occurred.

**2-119. Caution Panel.** The pilot's master caution panel (see figure 2-25) is located on the right console. When illuminated the worded segment

lettering in panel will be aviation yellow, however, when they are not illuminated the lettering will not be readable. Illumination of any of the worded segments on the caution panel alerts the pilot to a fault condition or conditions. The panel is equipped with a RESET-TEST switch, a BRIGHT-DIM switch and two edge lights for illuminating the switches. Electrical power to the caution panel is supplied from the 28 volt dc essential bus. Circuit protection is provided by the CAUTION LIGHT circuit breaker on the dc circuit breaker panel. This panel functions to provide the pilot visual indications (day or night) of fault conditions. The fault conditions and segment wording are as follows:

<u>Caution Panel Segment Wording</u>	<u>Fault Conditions</u>
ENGINE OIL PRESS.	Low engine oil pressure
ENGINE AIR	Negative air pressure in engine induction system
ENG OIL BYPASS	Engine oil bypassing oil cooler
FWD FUEL BOOST	Forward fuel boost pump pressure low
AFT FUEL BOOST	Aft fuel boost pump pressure low
ENG FUEL PUMP	One side and/or both sides of engine fuel pump producing low pressure
10% FUEL	Low fuel quantity
FUEL FILTER	Fuel filter is partially obstructed
GOV EMER	Governor switch in emergency position
XMSN OIL BYPASS	Transmission oil bypassing oil cooler
XMSN OIL PRESS	Transmission oil pressure is below minimum
XMSN OIL HOT	Transmission oil temperature is at or above red line
HYD PRESS 1	System 1 hydraulic pressure is low
HYD PRESS 2	System 2 hydraulic pressure is low
INST INVERTER	AC inverter has failed
DC GENERATOR	DC generator has failed
EXTERNAL POWER	External power receptacle door open
CHIP DETECTOR	Foreign metal particles in transmission or engine or tail rotor gear box
IFF	IFF system inoperative

**2-120. Bright-Dim Switch.** The bright-dim switch on the pilot's caution panel permits the pilot to manually select a bright or dimmed condition for all the individual worded segments and the master caution indicator light on the instrument panel. After each initial application of power, the lamps will come on in the bright condition, momentarily placing the switch in the up position selects the BRIGHT condition, down position selects the DIM condition.

**Note**

Segments will dim only when pilot's console lights are on.

**2-121. Reset-Test Switch.** The pilot's caution panel is provided with a reset-test switch enabling the pilot to manually reset and test the master caution system. This switch is labeled RESET in the forward position and TEST in the aft position. Momentarily placing the reset-test switch in the RESET position extinguishes and resets the master caution indicator light

on the instrument panel so it will again illuminate should another fault condition occur. Momentarily placing reset-test switch in TEST position will cause the illumination of all the individually worded segments and also the master caution indicator. Testing of the system will not change any particular combination of fault indications which might exist prior to testing.

**Note**

The worded segments will remain illuminated so long as fault condition or conditions exist.

**2-122. Gunner's Master Caution Panel.** The gunner's master caution panel (figure 2-26) is located in the right side of the instrument panel. The illumination of the segments from a fault condition will stay illuminated until the fault has been corrected or the segment rotated in the panel which opens the electrical circuit to the segment bulbs. The fault conditions and segment wording are as follows:

<u>Caution Panel Segment Wording</u>	<u>Fault Conditions</u>
ENGINE OIL PRESS	Low engine oil pressure
ENGINE AIR	Negative air pressure in engine induction system
ENG FUEL PUMP	One side and/or both sides of engine fuel pump producing low pressure
10% FUEL	Low fuel quantity
FUEL FILTER	Fuel filter is partially obstructed
GOV EMER	Governor switch in emergency position
DC GENERATOR	DC generator has failed
XMSN OIL PRESS	Transmission oil pressure is at or above red line
XMSN OIL HOT	Transmission oil temperature is at or above red line
CHIP DETECTOR	Foreign metal particles in transmission or engine or tail rotor gear boxes
HYD PRESS NO. 1	System 1 hydraulic pressure is low
HYD PRESS NO. 2	System 2 hydraulic pressure is low
INST INVERTER	AC inverter has failed
EXTERNAL POWER	External power receptacle door open

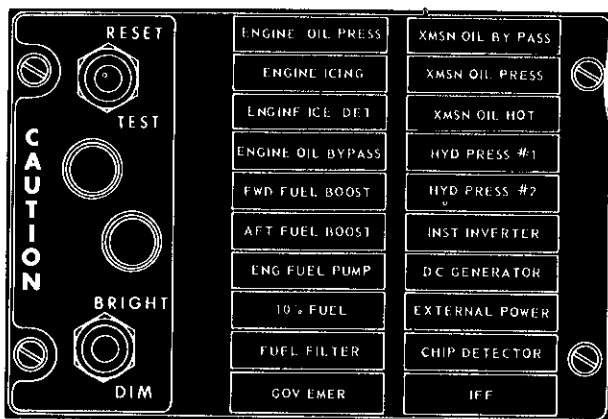

209075-1A

Figure 2-25. Pilot's master caution panel

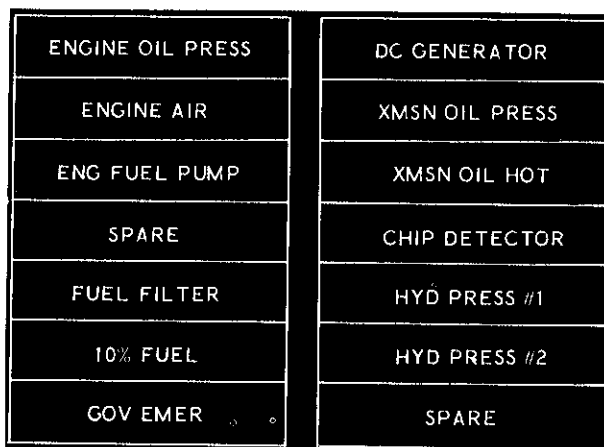

209075-2A

Figure 2-26. Gunner's master caution panel

**2-123. RPM High-Low Limit Warning System.** The rpm high-low warning system provides the pilot with an immediate warning of high and low rotor and/or engine rpm. Main

components of the system consist of the chassis black box unit, ON-OFF audio switch, warning light, electrical wiring and connectors. The light warning and audio warning function when the following rpm conditions exist:

Light Warning and Audio Warning  
in Combination

For rotor rpm at 295 plus or minus 5 or below, or engine rpm of 6000 plus or minus 100 or below or both (Low Warning)

Caution Light Only

For rotor rpm of 335 plus or minus 5 or above (High Warning)

**Note**

The audio warning will be heard in the pilot's and gunner's headsets. The audio is a varying oscillating frequency starting low and building up to a high pitch, on for 0.85 second interval, then off for 1.25 second, then on.

**Note**

For low rpm warning the audio warning functions in conjunction with the light.

**2-124.** Electrical power for system operation is supplied from the 28 volt dc essential bus and circuit protection is provided by a circuit breaker on the dc circuit breaker panel.

**2-126. Switch-Low RPM Audio ON-OFF.** The ON-OFF audio switch is located at the left of the main fuel switch on the engine panel. The audio switch in OFF position prevents audio warning from functioning for engine starting when the audio might be objectionable. The audio switch automatically resets to ON position when the engine and rotor rpm reach normal operating rpm.

**2-125. Light High-Low RPM Warning.** The high-low warning light is located on the upper left area of the pilot's instrument panel. This light illuminates (red) to provide a visual warning of low rotor rpm, low engine rpm or high rotor rpm.

**2-127. Emergency Equipment.** The emergency equipment consists of fire extinguisher, first aid kit and canopy break out knife (see

figure 2-27); Provisions are provided for two survival kits.

**2-128. Fire Extinguisher.** A portable fire extinguisher is carried in a bracket located on the bulkhead to the left of the gunner's seat.

**2-129. First Aid Kit.** An aeronautical type first aid kit is located on the aft bulkhead of the crew compartment and just to the left of the center line of the helicopter.

**2-130. Break Out Knife.** A break out knife is located on the right canopy sill — just forward of the pilot's canopy door.

**2-131. Survival Kits Stowage.** Provisions have been provided on the crew compartment's aft bulkhead to secure two survival kits and is located to the right of the first aid kit.

**2-132. Doors.** Access to the helicopter crew compartment is accomplished through the pilot's and gunner's canopy doors.

**2-133. Crew Compartment Access.** The pilot's and gunner's access is provided by canopy doors that are hinged at the top and swing outward and up. The pilot's canopy door opening is on the right side and the gunner's is on the left side. Both will lock in the full open and in any intermediate position. Canopy doors are individually jettisonable from the respective cockpit.

**2-134. Pilot's and Gunner's Seats.** The pilot's and gunner's seats are positioned in a tandem arrangement. The gunner's seat is in the forward position and the pilot's seat is in the aft position (see figure 2-1).

**2-135. Pilot's Seat.** The pilot's seat is vertically adjustable non-reclining type. The vertical adjustment is reclined at 15 degrees. The vertical height adjustment handle is on the right side of the seat. The seat back and bottom is made of three-sixteenth inch armor plate. The sides are of one-fourth inch steel. The hip and shoulder areas are covered with ceramic panels that are five-eighths inch thick. The seat is equipped with a lap safety belt and inertia reel shoulder harness.

1. Breakout Knife
2. Survival Kit Stowage
3. First Aid Kit
4. Fire Extinguisher

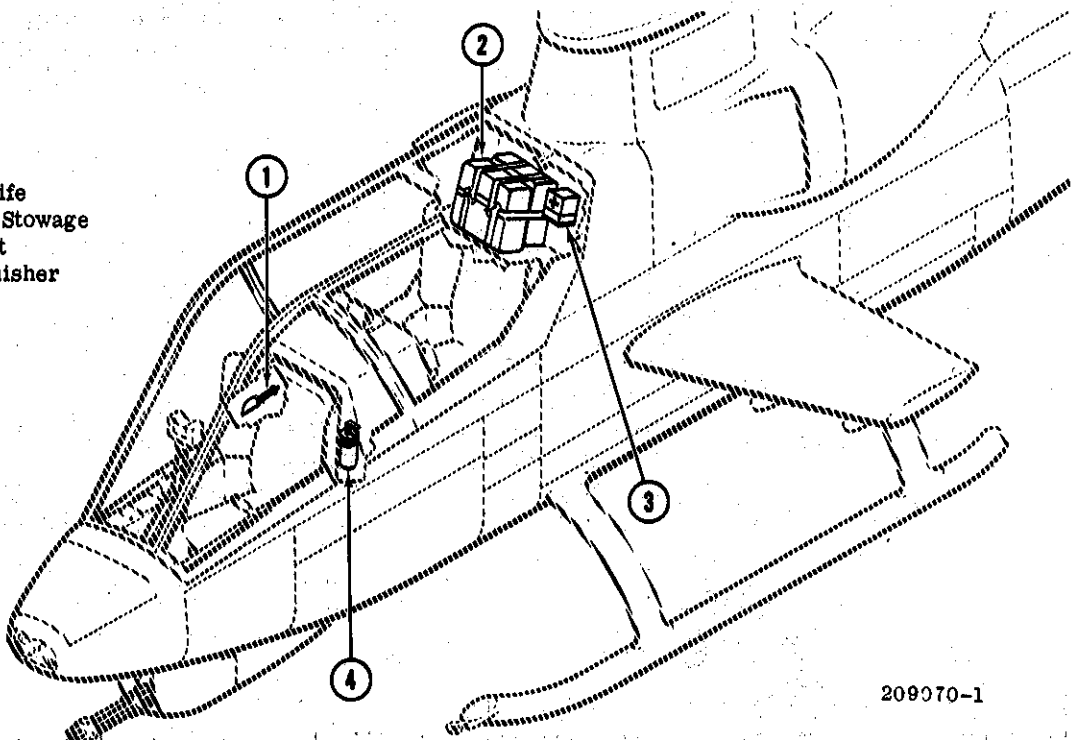

209070-1

Figure 2-27. Emergency equipment

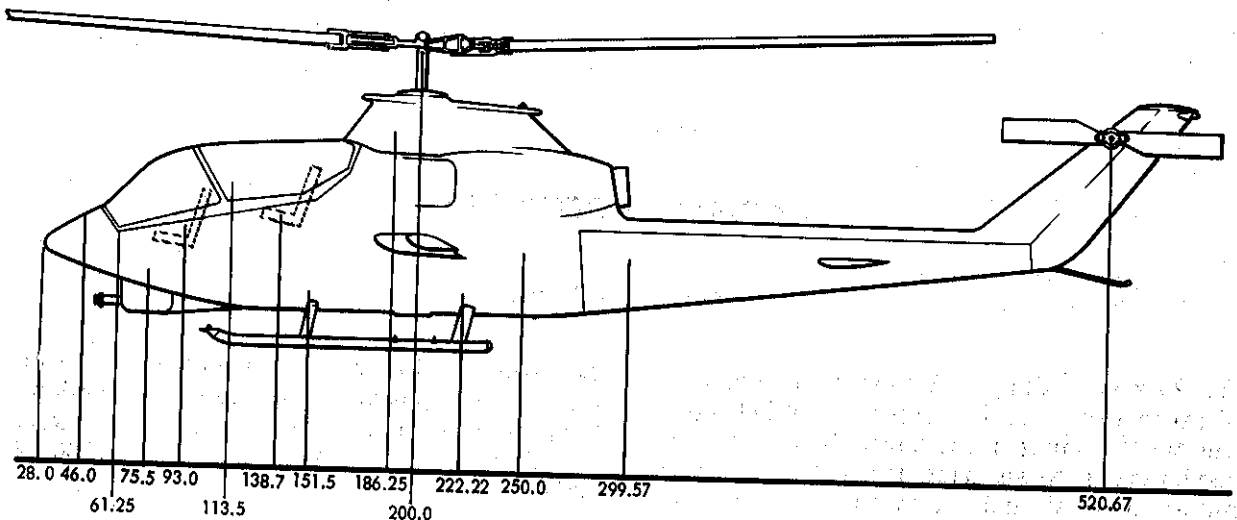

Figure 2-28. Stations diagram

209478-3B

**2-136. Gunner's Seat.** The gunner's seat is a fixed seat (non-adjustable and non-reclining). The gunner's seat is made of ceramic type armor plate. The seat is equipped with a lap safety belt and inertia-reel shoulder harness.

**2-137. Shoulder Harness.** An inertia-reel and shoulder harness is incorporated in the pilot's and gunner's seat with a manual lock-unlock control handle. With the control in the unlocked position, the reel cable will extend to allow the occupant to lean forward; however, the reel will automatically lock when helicopter encounters an impact force of two to three "G" deceleration. Locking of the reel can be accomplished from any position and the reel will automatically take up the slack in the harness. To release the lock it is necessary to lean back slightly to release tension on the lock and move the control handle to the lock and then unlock position. It is possible to have pressure against the seat back whereby no additional movement can be accomplished and the lock cannot be released; if this condition occurs, it will be neces-

sary to loosen shoulder harness. Manual locking of the reel should be accomplished for emergency landings.

**2-138. Stations Diagram.** For station locations refer to figure 2-28.

**2-139. Auxiliary Equipment.** The following auxiliary equipment is described in Chapter 6.

- Ventilating System
- Heating System
- Engine Anti-Icing
- Pitot Heater
- Rain Removal
- Lighting Equipment
- Armament Systems
- Data Case
- Mooring Fittings
- Rotor Tie Down
- Tow Rings
- Tailpipe Cover
- Pitot Tube Cover
- Electrical External Stores Jettison

## CHAPTER 3

## NORMAL PROCEDURES

## Section I — Scope

**3-1. Purpose.** Chapter 3 contains instructions and procedures covering flight of the helicopter from the planning stage through actual flight considerations to securing the helicopter after landing. Normal and standard conditions are assumed in these procedures. Pertinent data in other chapters is referenced when applicable.

**3-2.** Normal procedures are given in checklist form when applicable. A condensed version of these procedures is contained in the condensed checklist Technical Manual TM 55-1520-221-10CL.

## Section II — Flight Procedures

**3-3. Preparation for Flight.** This period should be devoted to matters of general mission planning and a study of special problems involved in operating the aircraft for mission completion.

for detail operating information when planning various types of missions that require use of the data cards.

**3-4. Flight Restrictions.** Refer to Chapter 7 of this Technical Manual for flight restrictions due to helicopter operating limitations.

**3-7. Weight and Balance.** Ascertain proper weight and balance of the helicopter as follows:

**3-5. Flight Planning.** The safe and efficient planning of the mission to be accomplished will provide the pilot with the data to be used during flight. The information to be used can be compiled from the following sources.

a. Consult applicable weight and balance instructions given in Chapter 12, and ascertain that DD Form 365F has been completed properly.

a. Check type of mission to be performed, and destination.

b. Compute take-off and anticipated landing gross weight, checking helicopter CG and location and ascertaining weight of fuel, oil, payload, etc.

b. Select performance charts to be used from Chapter 14.

c. Check that loading limitations, described in Chapter 7, have not been exceeded.

c. Record for in-flight use, the information concerning fuel quantity required, airspeed, power settings, take-off, climb, cruise or hovering condition, landing and fuel consumption for operating gross weight and climatic condition.

**3-8. Pre-Flight Check.** The amplified preflight check includes the exterior and interior checks as outlined.

**3-9. Before Exterior Check.** Check fuel and oil servicing data requirements as given in Chapter 2.

**3-6. Take-Off and Landing Data Cards.** Take-off and landing data cards in format for local reproduction are contained in TM 55-1520-221-10CL. Consult Chapter 14, Performance Data,

**Warning**

Pre-flight should not be initiated until the armament sub-system is determined to be safe.

- a. Check DA Form 2408.
- b. Check Battery Switch — OFF.

**3-10. Exterior Check.** The designated exterior check areas are shown in figure 3-1. The following checks reference these areas.

**Note**

Be certain that helicopter is clear of all obstructions, including other aircraft.

**3-11. Fuselage and Main Rotor — Right Side — Area 1.** a. Canopy — Condition.

b. Landing Gear — Condition and cleanliness, handling wheels and jacking lug removed.

c. Engine Air Intake Shield — Removed.

d. Engine Air Intake — Condition.

e. Cowling Latches — Secured.

f. Wing — Condition of wing and external stores mounting.

g. Transmission Oil Level — Check.

h. Sumps — Drain.

i. Navigation Light — Condition and Cleanliness.

j. Engine Oil Level — Check.

k. Main Rotor — Condition.

**3-12. Tail Section — Right Side — Area 2.** a. Air Ejection Area — Condition and Cleanliness.

b. Elevator — Condition and Security.

c. 42° Gear Box — Visually check oil level.

d. 90° Gear Box — Visually check oil level.

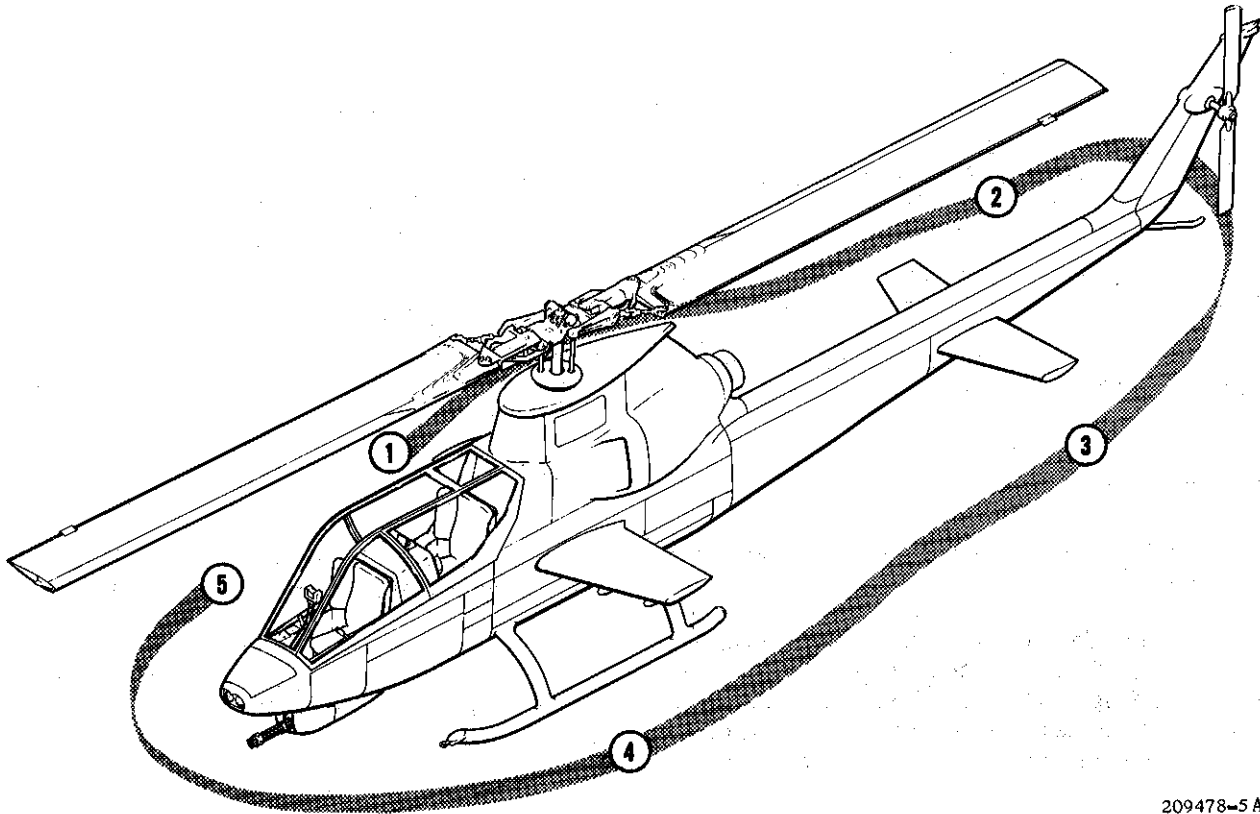

209478-5 A

**Figure 3-1. Exterior check diagram**

e. Upper Fin — Condition.

f. Tail Skid — Condition.

**3-13. Tail Section — Left Side — Area 3.** a. Upper Fin — Condition.

b. Tail Rotor — Condition, free movement on flapping axis.

c. Main Rotor Tie-Down — Removed.

d. Elevator — Condition and security.

e. Tail Pipe Cover — Removed.

f. Air Ejection Area — Condition and cleanliness.

**3-14. Fuselage and Main Rotor — Left Side — Area 4.** a. Main Rotor — Condition.

b. Hydraulic Oil Level — Check.

c. Engine Air Intake Shield — Removed.

d. Engine Air Intake — Condition.

e. Navigation Light — Condition.

f. Wing — Condition of wing and external stores mounting.

g. Landing Gear — Condition and clean, handling wheels and jacking lug removed.

h. Search Light — Condition (If installed).

i. Ammunition Bays — Check, secure door.

j. Canopy — Condition.

**Caution**

If single pilot operation is to be conducted, the following items must be accomplished in the gunner's cockpit at this time.

(1) Safety belt and shoulder harness — Secured.

(2) Loose equipment — Secured or removed.

(3) Canopy hatch jettison handle — Secured and safetied.

(4) ELECTrical PWR switch — fwd, (ON), safetied.

(5) INSTRument LTS switch — OFF.

(6) GOVERNOR switch — AUTO, safetied.

(7) EMERGENCY COLLECTive HYDRAULIC switch — OFF.

(8) Armament Control panel switches — Set.

(9) Sight — Stowed and Secured.

(10) Knife — Stowed.

(11) Gunner's canopy hatch — Closed and locked.

**3-15. Nose Section — Area 5.** a. Landing Light — Condition.

b. Pitot Tube — Cover removed and pitot tube condition.

c. Static ports — Clean.

d. Windshield — Condition and cleanliness.

e. Battery — Condition and connected.

f. Nose Compartment Door — Secured.

**3-16. Armament — See Chapter 6.**

**3-17. Interior Check — After exterior check accomplish interior check.**

a. Gunner.

(1) Canopy hatch — As desired.

**Caution**

An open canopy is susceptible to possible damage from helicopters operating nearby.

(2) Pedals — Adjust.

(3) Safety belts and shoulder harness — Fastened.

(4) Operation of shoulder harness lock — Check.



(5) Canopy hatch jettison handles — Secured and safetied.

(6) ELEctrical PWR switch — fwd (ON), Safetied.

(7) INSTRument LTS — OFF.

(8) GOVernor switch — AUTO, Safetied.

(9) Altimeter — Set.

(10) Armament control panel switches — Set.

(11) Loose equipment — Secured.

(12) CAUTION PANEL switch — Test.

(13) Headset — ON.

b. Pilot.

(1) Canopy hatch — As desired.

**Caution**

An open canopy is susceptible to possible damage from helicopters operating nearby.

(2) Main rotor tiedown, pitot cover, engine intake shields and tailpipe cover — Stowed.

(3) Throttle — OFF.

(4) Landing light switch — OFF.

(5) Search light switch — OFF.

(6) Collective down lock — As required.

(7) ENGINE AIR switch — SCREEN.

(8) RPM WARNING switch — OFF.

(9) FORCE TRIM switch — fwd (ON).

(10) HYDdraulic TEST switch — Centered.

(11) EMERgency COLlective HYDraulic switch — OFF.

(12) FUEL switch — OFF.

(13) SAS POWER switch — OFF.

(14) Armament switches — As required.

(15) MASTER ARM switch — OFF.

(16) Instruments — Check static indications, slippage marks and operating range limits.

(17) COMPASS SLAVING — IN.

(18) BATTery switch — OFF.

(19) GENERator switch — OFF.

(20) Inverter switch — OFF.

(21) NON-ESSential BUS switch — NORMAL (ON).

(22) ANTI-COLLision light switch—OFF.

(23) POSITION Lights switch — OFF.

(24) Intercom — As desired.

(25) Instrument Lights switch — OFF.

(26) CONSOLE Lights switch — OFF.

(27) CABIN Heater switch — OFF.

(28) PITOT Heater switch — OFF.

(29) Circuit breakers (AC and DC) — IN.

(30) Knife — Stowed.

(31) BATTery switch — ON, OFF if using APU.

(32) INVerter switch — MAIN.

(33) Caution panel and master caution lights — TEST.

(34) Caution panel test button — TEST.

**Note**

This button tests the lights in the four chip detector lights (42° gear box, 90° gear box, main transmission and engine).

(35) Fuel gage test switch — TEST.

(36) FUEL switch — ON.

(37) Fuel pressure gage — CHECK.

(38) Throttle — Flight idle, check engine idle stop release and position throttle just below flight idle (for abort start purposes).

(39) GOVERNOR RPM INCREASE — DECREASE switch — Decrease eight to ten seconds.

**3-18. Starting Engine.** Ascertain that the rotor paths are clear and fire guard posted.

**Caution**

The battery should be fully charged prior to initiating a start. A discharged battery may cause a hot start. If voltage drops below 14 vdc, indicated at 10 percent nI speed during start, abort start.

a. Starter Trigger — ENERGIZE.

**Note**

The L-13 inherently starts slower and hotter than the L-11, and in some cases, 30 seconds are required to reach 40 percent nI when using the aircraft battery as a power source.

b. EGT and gas producer gages — MONITOR.

**Caution**

Monitor EGT to avoid a hot start. During starting or acceleration, the maximum EGT is 760°C. Do not exceed 675°C for more than five seconds. If either of the above limits are exceeded, perform hot end inspection.

c. Starter Trigger — Release at 40 percent nI.

d. Throttle — Advance to flight idle.

e. Engine and transmission oil pressures — CHECK.

f. Caution panel — MONITOR.

g. Radios — ON.

h. APU — Disconnect, if applicable, and turn on GENERATOR and BATTERY switches.

i. Collective down lock — RELEASED.

**3-19. Engine Run-Up.** Retard the throttle to the flight idle stop and check the following.

a. Gas Producer — 70 to 72 percent RPM.

b. Engine and transmission oil pressures — CHECK.

c. Fuel Pressure — CHECK.

d. Master Caution Light — OFF.

e. RPM Warning switch — CHECK AUDIO.

f. Throttle — Slowly increase to full open (6000 plus or minus 50 RPM).

g. SAS POWER switch — ON.

h. Engine and Transmission Instruments — NORMAL.

i. ENGINE AIR — DE-ICE, note EGT rise.

j. ENGINE AIR — SCREEN, note EGT decrease.

k. GOVERNOR RPM Increase-Decrease switch — Check range (6000 to 6700) and set at 6600 RPM.

l. RPM WARNING switch — fwd (ON).

m. HYDRAULIC TEST switch — Push and hold to SYSTEM 1.

n. Cyclic and Collective — Check freedom of movement; note HYD PRESS No. 2 warning light on caution panel. Pedal movement should be free.

o. HYDRAULIC TEST switch — Push and hold to position SYSTEM 2.

p. Cyclic and Collective — Check freedom of movement; note HYD PRESS No. 1 system warning light on caution panel. Pedal movement should be stiff.

q. HYDRAULIC TEST switch — RELEASE SWITCH.

r. EMERGENCY COLLECTIVE HYDRAULIC switch — OFF.

s. FORCE TRIM switch — OFF. Check cyclic and pedals for freedom of movement.

increasing power to maximum available torque pressure (not to exceed redline) and assume a 40 knot airspeed attitude. As power is increased, maintain heading by smoothly coordinating tail rotor pedals. When sufficient altitude for obstacle clearance is obtained, smoothly increase airspeed and reduce power to establish a normal climb.

#### Note

The bleed air heater (RAIN REMOVAL-HEAT switch) should be in the OFF position during take-off, landing and other flight conditions requiring maximum engine power available.

**3-25. Crosswind Take-Off.** In the event a crosswind take-off is required, normal take-off procedures are used. As the helicopter leaves the ground, there will be a definite tendency to drift downwind. This tendency can be corrected by holding the cyclic stick into the wind a sufficient amount to prevent downwind drift. When a crosswind take-off is accomplished, it is advisable to turn the helicopter into the wind for climb as soon as obstacles are cleared and terrain permits.

**3-26. After Take-Off.** As the helicopter accelerates from hovering flight to flight in any direction, it passes through a transitional period. If engine power, RPM, and collective pitch are held constant in calm air, a momentary settling will be noted when the cyclic control stick is moved forward to obtain forward speed. This momentary settling condition is a result of the helicopter moving from the ground cushion and the tilting of the tip-path plane of rotation of the main rotor blades to obtain forward airspeed. Wind velocity at the time of take-off will partially eliminate this settling due to the increased airflow over the main rotor blades. As wind velocity increases, this settling will be less pronounced. After the helicopter accelerates forward to 10 to 15 knots airspeed, less power is required to sustain flight due to increase in aerodynamic efficiency as airspeed is increased to best climbing speed. Take-off power should be maintained until a safe autorotative airspeed is attained, then power may be adjusted to establish the desired rate of climb.

**3-27. Climb.** During climbs at low altitude a safe autorotative airspeed should be maintained

so that in the event of engine failure, sufficient but not excessive airspeed is available to accomplish a safe autorotative landing. Airspeeds to avoid at low altitudes are shown on figure 7-3. If necessary to clear ground obstructions after take-off, vertical climbs can be accomplished; however, operation within the shaded area on figure 7-3, should be kept to a minimum. Accelerating the helicopter to the optimum climbing airspeed, in a shallow climb, eliminates critical settling and the possibility of the helicopter striking the ground on take-off.

**3-28. Cruise Checks.** These checks consist of constantly monitoring instruments, to be cognizant of any change in performance or condition.

**3-29. Flight Characteristics.** The helicopter is capable of delivering a maximum thrust commensurate with rotor-engine limitations and the density altitude in which it is operating. Maximum thrust can be utilized to obtain maximum airspeed, optimum rate of climb or at some reduced airspeed, the maximum maneuver potential. The capabilities of the helicopter may be employed with maximum limitations and in accordance with the environment under which operated. The capabilities of the helicopter in stabilized flight conditions are clearly and accurately defined in Chapter 7, and Chapter 14.

**3-30. Before Landing Check.** Before landing accomplish following check.

- a. Alert gunner.
- b. Collective Friction — ADJUST.
- c. Engine RPM — 6400 to 6600 RPM.
- d. Instruments — CHECK WITHIN OPERATING LIMITS.
- e. Shoulder Harness — Lock (Pilot and Gunner).
- f. Armament switches — As required.

**3-31. Approach and Landing Procedures.** Before approach and landing are accomplished, the pilot should evaluate the landing site for suitability of usable area by making a low speed pass into the wind over the intended landing site. Evaluate terrain, check wind direction, velocity and consistency. The gross

weight of the helicopter must be considered; and the final step in evaluation of a landing, is the anticipated helicopter performance during landing and subsequent take-off.

**3-32. Normal Approach.** (See figure 3-2.) The objective of a normal approach and landing is to bring the helicopter to a hover over the spot of intended landing. The airspeed is decreased gradually and a constant approach angle of 8 to 10 degrees established at an engine speed of 6600 rpm. In case of undershooting or overshooting, the approach angle is corrected by increasing or decreasing the power and the collective pitch. As the landing spot is approached the airspeed and the rate of descent are decreased in order to attain a hovering attitude at approximately three feet.

**3-33. Steep Approach.** The steep approach procedure is a precision, power-controlled approach used to clear obstacles and to accomplish a landing in confined areas. The rate of descent in a steep approach should not exceed approximately 400 fpm with a constant approach angle of 12 to 15 degrees and some forward airspeed should be maintained at all times. Since a reasonable amount of power will be required to control the rate of descent (power required is governed by the gross weight and atmospheric conditions) a minimum amount of additional power will remain to accomplish a hover. The airspeed is decreased by holding the cyclic stick aft. The rate of descent is controlled by proper application of power and collective pitch. In the final stages of approach, the collective pitch is increased gradually and the cyclic stick is adjusted to maintain the originally established glide angle in a way which will reduce the rate of descent to zero the moment the hovering altitude is reached.

**Caution**

Never reduce forward airspeed to zero before reaching hovering altitude. If the landing spot has been overshot, execute a go-around immediately.

**Warning**

Due to lag in acceleration, which is inherent in turbine engines, a need for power should be anticipated in time to allow for the acceleration lag. As much as a four second delay may be encountered from low power (bottom pitch) to full power.

**3-34. Normal Landing.** With an engine rpm at 6400 to 6600, decrease collective pitch to effect a constant, smooth rate of descent until touchdown, making necessary corrections with pedals and cyclic control to maintain level attitude and constant heading and to prevent movement over the ground. Upon contact with the ground, continue to decrease collective pitch smoothly and steadily until the entire weight of the helicopter is resting on the ground.

**3-35. Slope Landing.** Make the slope landing by heading the helicopter generally cross-slope. Slope landing should be made cross-slope with skid type gear. Descend slowly, placing the up-slope skid on the ground first. Coordinate reduction of collective pitch with lateral cyclic (into the slope) until the downslope skid touches the ground. Continue coordinating reduction of collective pitch and application of cyclic into the slope until all the weight of the aircraft is resting firmly on the slope. If the cyclic control contacts the stop before the downslope skid is resting firmly on the ground, return to hover, and select a position where the degree of slope is not so great. After completion of a slope landing, and after determining that the aircraft will maintain its position on the slope, place the cyclic stick in neutral position.

**3-36. Crosswind Landing.** Crosswind landings can generally be avoided in helicopter operations. Occasionally, plowed, furrowed or eroded fields, and narrow mountain ridges may require that crosswind landings be made. The crosswind landing, in such instances where terrain features dictate, is utilized to prevent landing at a high tipping angle or dangerous tail low attitude. Crosswind landing may also be accomplished on smooth terrain when deemed advisable by pilot. The following procedures should be observed in accomplishing crosswind landing:

- a. Engine RPM 6600.
- b. Hover helicopter crosswind.
- c. Hold the cyclic control stick into the wind to prevent side drift throughout the landing.
- d. Proceed as in normal landing.

**3-37. After Landing Check.** The engine post-flight check shall be performed after the last

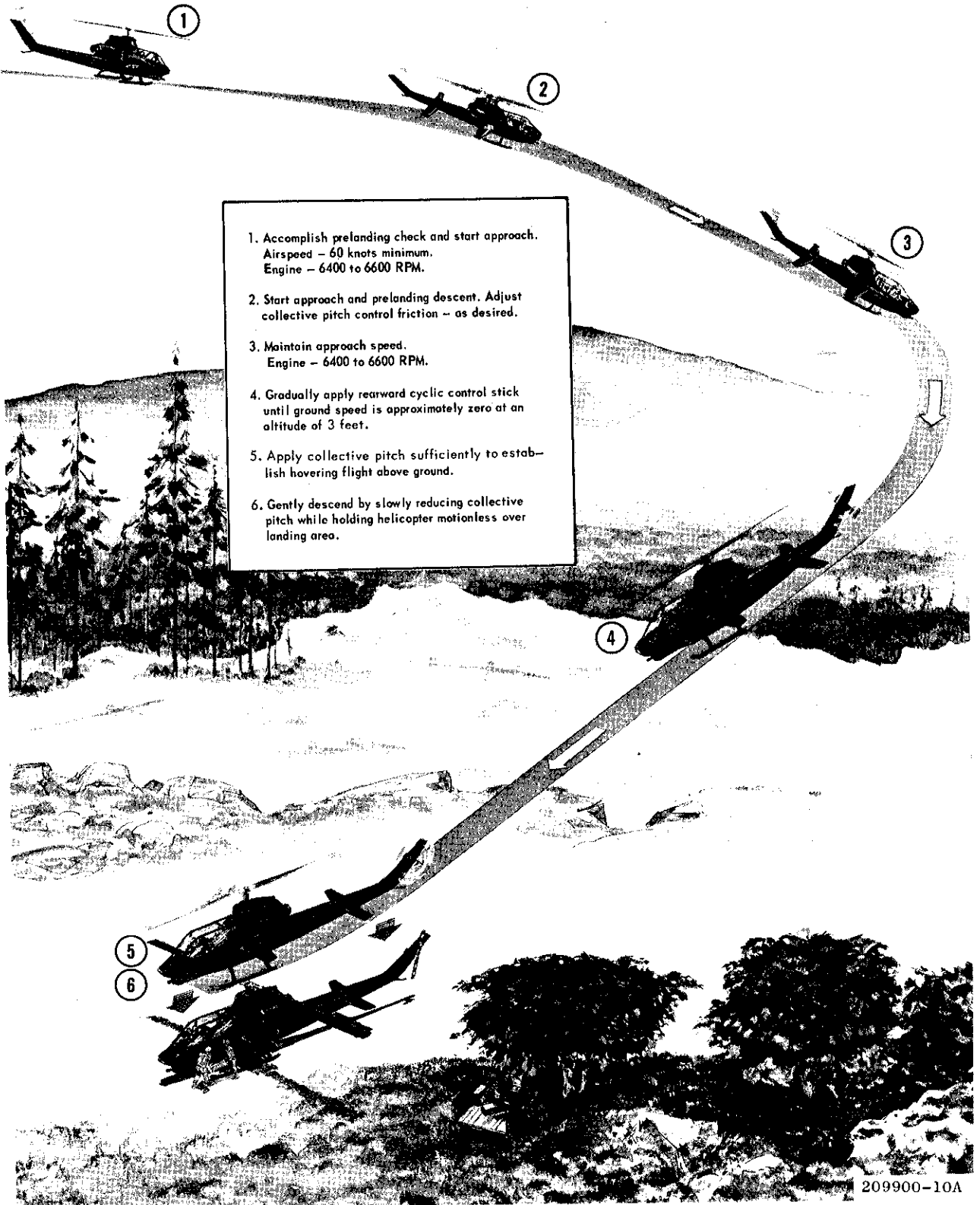

1. Accomplish prelanding check and start approach.  
Airspeed - 60 knots minimum.  
Engine - 6400 to 6600 RPM.
2. Start approach and prelanding descent. Adjust collective pitch control friction - as desired.
3. Maintain approach speed.  
Engine - 6400 to 6600 RPM.
4. Gradually apply rearward cyclic control stick until ground speed is approximately zero at an altitude of 3 feet.
5. Apply collective pitch sufficiently to establish hovering flight above ground.
6. Gently descend by slowly reducing collective pitch while holding helicopter motionless over landing area.

209900-10A

Figure 3-2. Normal approach and landing - Power ON

flight of the day or after any flight if engine malfunction occurs during flight. Enter complete information of engine and helicopter discrepancy, if circumstances require, on DA Form 2408.

- a. Throttle — Flight idle.
- b. Stabilize EGT by allowing engine to operate at flight idle from one to two minutes.
- c. Engine Oil Pressure — 25 psi minimum.
- d. Engine Oil Temperature — 93°C (200°F) maximum.
- e. Transmission Oil Pressure — 30 psi minimum.
- f. Transmission Oil Temperature — 110°C (230°F) maximum.

**3-38. Engine Shut-Down.** Proceed as follows for engine shut down:

- a. GOVERNOR RPM INCREASE - DECREASE switch — Decrease eight to ten seconds.
- b. Throttle — CLOSED.
- c. FUEL switch — OFF.

**Caution**

If a rapid rise in exhaust temperature is noted, with throttle closed and FUEL SWITCH OFF, motor the engine to allow temperature to stabilize within limits. Do not exceed 40 seconds continuous starter application.

Normal purging of the fuel system of the engine allows approximately 2 ozs. of fuel to flow overboard on shutdown. This creates a fire hazard in certain areas as well as damage to macadam surfaces. Extreme care should be utilized to prohibit the fire possibility.

**Note**

After stopping the engine a fuel pressure indication in excess of 30 psi may be observed, due to the expansion of fuel trapped between the fuel control and the fuel shut-off valve. This expansion is caused by radiation from the engine resulting in fuel pressure indication. Check valves located in the fuel system relieve pressure exceeding 40 to 45 psi and permit fuel to bleed into the fuel cells.

The FUEL valve must be closed as soon as engine has been stopped, to ensure that fuel does not drain from the engine fuel control and allow air to enter the fuel system. Fuel valve should remain in CLOSED position at all times when engine is not running.

**3-39. Before Leaving Helicopter.** Check the following:

- a. All electrical switches — OFF.
- b. Radio switches — OFF.
- c. Collective pitch control — FULL DOWN and engage DOWN lock.
- d. Moor aft main rotor blade with mooring block by drawing blade down lightly against static stop and tying web strap to the tail boom.
- e. Install exhaust cover and engine inlet shields.

**Caution**

In addition to the established requirements for reporting any system defects, unusual and excessive operations, the pilot will also make entries in DA Form 2408 to indicate when any limits in the Flight Manual have been exceeded.

## CHAPTER 4

### EMERGENCY PROCEDURES

#### Section I — Scope



**4-1. Scope.** This Chapter clearly and concisely describes the procedure to be followed in meeting any emergency except in connection with auxiliary equipment.

**4-2. Scope of Emergency Procedures.** Procedures in this Chapter describe action to be followed in emergencies, that can within reason be expected. In some cases emergency situations can be avoided by maintaining operation within the limitations described in Chapter 7.

**4-3. Emergency operation of auxiliary equipment** is contained in this Chapter insofar as its

utility affects safety of flight. Detail descriptions of this equipment are given in Chapter 6.

**4-4. Emergency procedures** are given in checklist form when applicable. A condensed version of these procedures is contained in the condensed checklist Technical Manual TM 55-1520-221-10CL.

**4-5. Emergency Exits and Equipment.** Refer to figure 4-1 for location of the emergency exits and equipment.

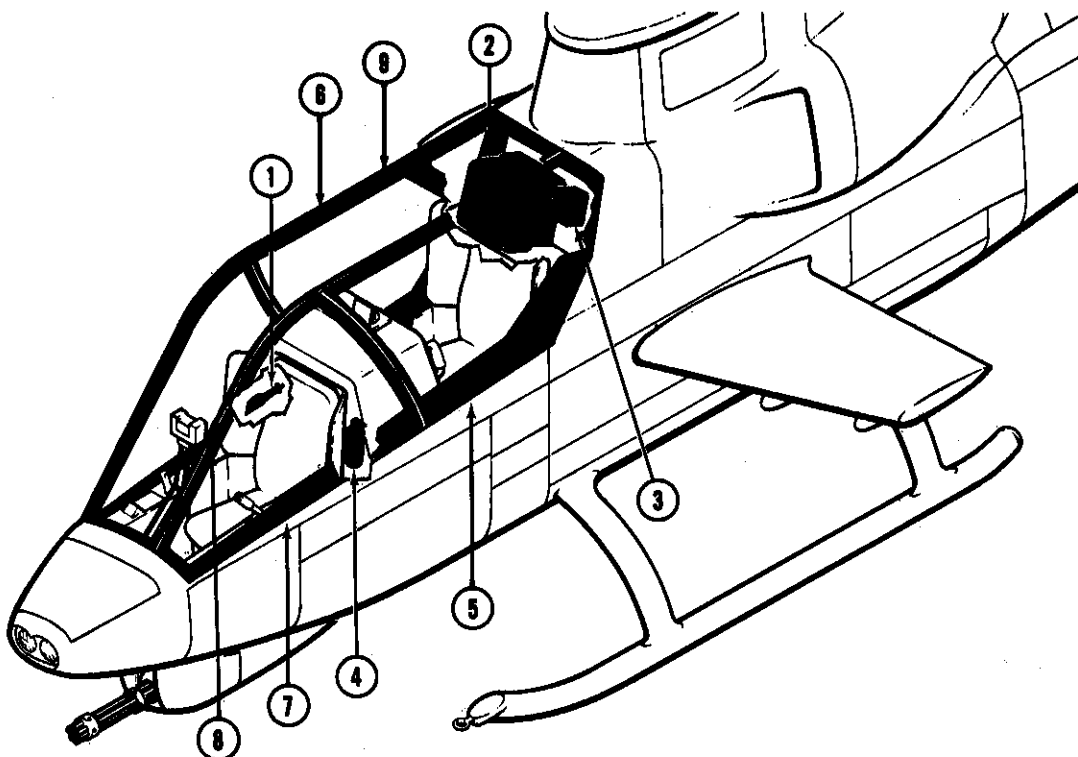

- |   |  |
|---|--|
| <ul style="list-style-type: none"> <li>1. Knife - Canopy Breakout</li> <li>2. Survival Kits Stowage (provisions)</li> <li>3. First Aid Kit</li> <li>4. Fire Extinguisher</li> <li>5. Pilot's Canopy Door</li> </ul> | <ul style="list-style-type: none"> <li>6. Canopy Jettisonable Release (Pilot's)</li> <li>7. Gunner's Canopy Door</li> <li>8. Canopy Jettisonable Release (Gunner's)</li> <li>9. Canopy Area</li> </ul> |
|---|--|

209070-2

**Figure 4-1. Emergency exits and equipment**

## Section II — Engine

**4-6. Engine.** This section sets forth the emergency procedures to be taken in the event of engine failure under various conditions.

**4-7. Flight Characteristics.** The handling characteristics of the helicopter without power are similar to those of a normal power descent. Full control is maintained by autorotative action of the main rotor and ground contact force is reduced by increasing main rotor pitch prior to landing.

**4-8. Autorotation.** Autorotation is the result of aerodynamic forces exerted on the main rotor blades, causing the rotor to continue to rotate without engine power. The rotation of the rotor, caused by the aerodynamic characteristics of the system, allows operating rotor rpm to be maintained, thereby, creating energy which is stored in the rotor system. This energy is utilized by the pilot to make a controlled descent and by application of the collective pitch, just prior to ground contact, a safe landing can be accomplished with a normal touch-down (see figure 4-2).

**4-9. Directional control during autorotation** is obtained through use of the cyclic stick and heading control is provided by the tail rotor which is powered by the main rotor through the transmission. Partial power and simulated autorotational descents shall be accomplished at approach speed not less than shown on power-off landing charts in Chapter 14.

### Note

When making a forward speed autorotation landing with skid gear, carefully increasing collective pitch just prior to ground contact will result in a slower rate of descent. Deceleration is obtained by reducing main rotor pitch after ground contact.

**4-10. Hot Start.** If an engine hot start is imminent, proceed as follows:

### Caution

If engine hot start is imminent (uneven acceleration accompanied by a rapid rise in EGT) abort start under all circumstances and investigate cause.

a. Throttle — Maintain normal start position and continue to energize starter.

b. GOVERNOR switch — EMERGENCY.

### Caution

If EGT rise is not checked below 650°C, abort, start by closing throttle, turning fuel "OFF" and motoring starter for 15 to 20 seconds.

c. Starter trigger — Release at 40 percent nI.

d. EGT — stabilized below 600°C.

e. Throttle — Slowly advance to 60 percent nI.

f. Throttle — Retard to flight idle stop.

g. GOVERNOR switch — AUTOMATIC.

h. Gas producer — 70 to 72 percent.

**4-11. Engine Failure — 0 to 40 Knots Airspeed and below 100 Feet Altitude.** a. From a condition of low airspeed and low altitude flare capability is limited and caution should be used to avoid striking the ground with the tail rotor. Initial collective reduction varies with altitude — from low altitude hover, collective can not be reduced but must be increased — to cushion touch down. From 100 foot altitude and 40 knots, a partial reduction of collective to lose altitude and help maintain rpm — is necessary prior to increasing collective to cushion touch down.

b. After landing.

(1) Throttle — CLOSED.

(2) FUEL switch — OFF.

(3) SAS — OFF.

(4) BATTERY and GENERATOR switch — OFF.

**4-12. Engine Failure — 40 to 120 Knots Airspeed and Above 100 Feet Altitude.** a. From a condition of medium speed and altitudes above 100 feet — cyclic flare and collective should be coordinated as required to maintain rpm and set up a recommended approach speed of 60 to 70 knots.



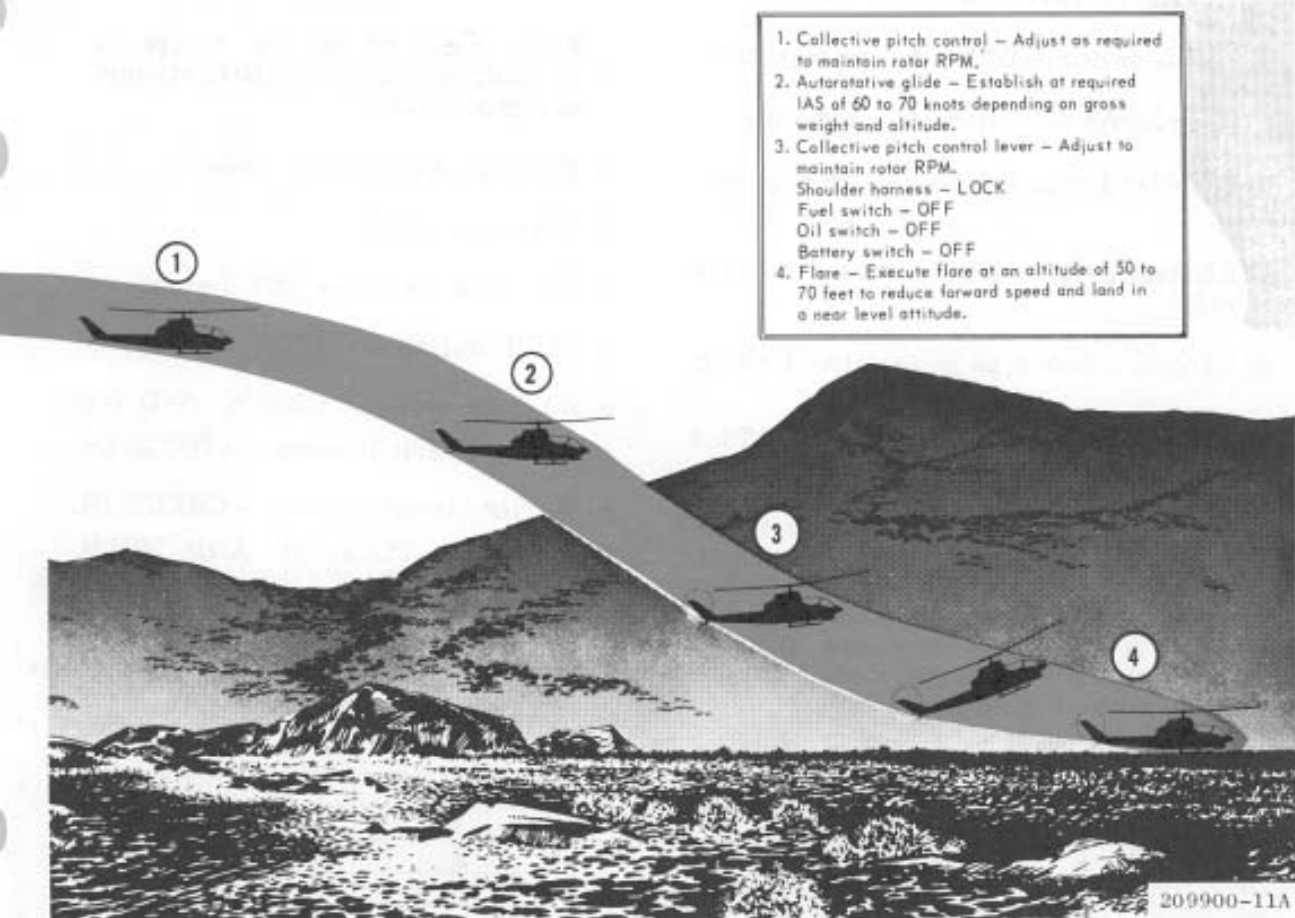

Figure 4-2. Normal approach and landing — power OFF

**Note**

The 60-70 knot speed range is recommended for approach because it is the approximate speed for minimum rate of descent (see figure 4-3) and also because it represents a good compromise between ground speed and flare effectiveness.

- b. FUEL switch — OFF.
- c. Wing Stores — Jettison as appropriate.
- d. Shoulder Harness — Locked (if time permits).
- e. BATTERY switch — OFF (unless lights are required).
- f. Execute a flare type autorotative landing.

**Note**

The flare type landing is recommended, when conditions permit, because of three significant advantages derived from the flare.

- Reduction of rate of descent.
- Reduction of ground speed.
- Increased rotor rpm.

**4-12A. Engine Failure — 120 to 190 Knots Airspeed.**

a. From the higher speed range — FIRST — initiate cyclic flare. The flare and partial collective reduction should be coordinated as required to maintain rpm. The pilot also has the capability of maintaining or in some cases increasing his altitude — depending on speed and the steepness of the flare utilized.

Speed should be reduced to 60-70 knots.

- b. FUEL switch — OFF (if time permits).
- c. Wing Stores — Jettison as appropriate.
- d. Shoulder Harness — Locked (if time permits).
- f. BATtery switch — OFF (unless lights are required).
- g. Execute a flare type autorotative landing.

**Caution**

When cause of engine failure is obviously mechanical DO NOT attempt an engine restart.

- a. Establish Autorotative Glide.
- b. Throttle — OFF.
- c. GOVERNOR switch — EMERGENCY.
- d. FUEL switch — CHECK FWD (ON).
- e. BATtery switch — CHECK FWD (ON).
- f. Igniter Circuit Breaker — CHECK IN.
- g. Starter Circuit Breaker — CHECK IN.
- h. Starter — PULL ON AND HOLD — SIMULTANEOUSLY OPEN THROTTLE SLOWLY.
- i. EGT and Gas Producer Speed — MONITOR.

**4-13. Engine Restart During Flight.** The condition which would warrant an attempt to restart the engine would probably be an engine flameout caused by a malfunction of the fuel control unit or failure of the boost pumps. The decision to attempt an engine restart during flight is the pilot's responsibility and is dependent upon pilot's experience and the operating altitude. If an engine restart is to be attempted, proceed as follows:

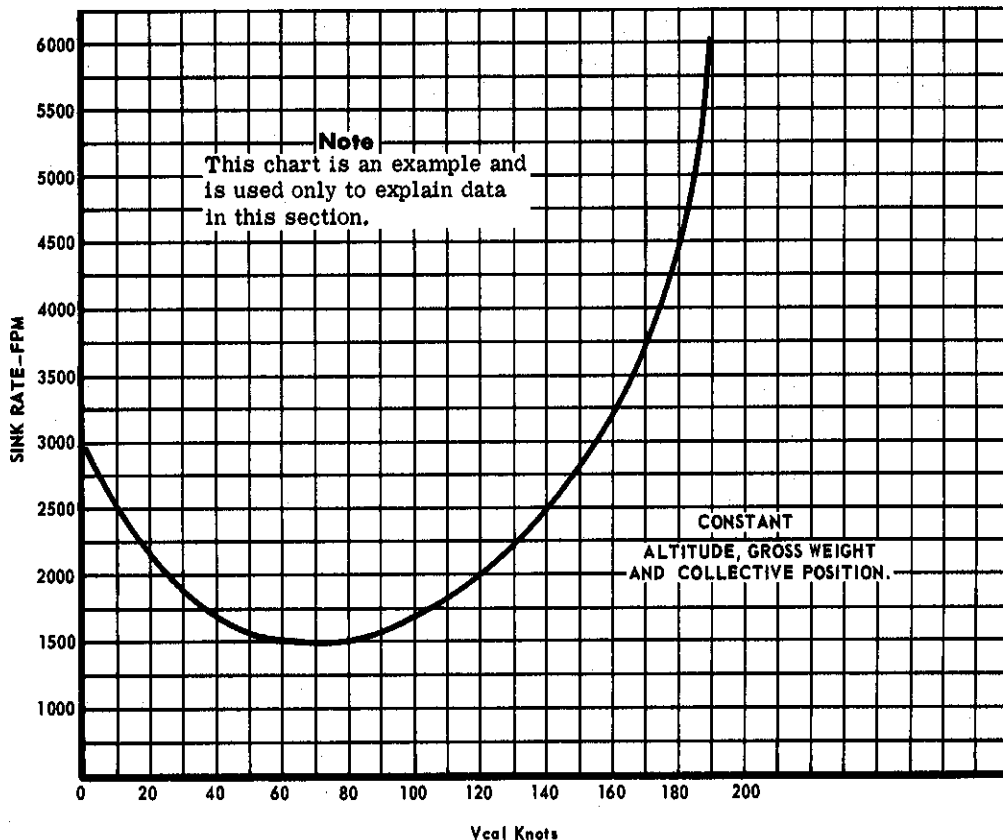

209900-25

Figure 4-3. Rate of descent versus airspeed

j. Starter Trigger — Release at 40 percent nI.

k. Engine Instruments — CHECK.

l. GOVERNOR Switch — LEAVE IN EMERGENCY UNTIL FLIGHT IS TERMINATED.

b. ENG AIR switch — DE-ICE position.

#### Caution

Do not exceed 100 knots IAS with the ENG AIR switch in either the DE-ICE or SCRNBYP position.

### 4-13A. Engine Icing.

#### Note

Engine icing is indicated by illumination of the master caution light and the caution panel segment ENGINE AIR.

a. IAS — 100 knots or less.

**4-14. Minimum Rate of Descent.** The power OFF minimum rate of descent is obtained by maintaining a forward speed of approximately 55 to 65 knots depending on gross weight and altitude.

**4-15. Maximum Glide.** A glide speed of approximately 90 to 100 knots will result in obtaining maximum gliding distance.

## Section III — Tail Rotor

**4-16. Tail Rotor Malfunction.** The following steps are a general discussion of tail rotor malfunctions.

a. A common tendency among helicopter pilots is to attempt to lump all types of tail rotor malfunction, and the corrective actions into a single category with a single solution. This is definitely not correct and any attempt to propose a single solution (emergency procedure) for all types of anti-torque malfunction could prove disastrous. The key to a pilot's successful handling of a tail rotor emergency lies in his ability to quickly analyze and determine the type malfunction that has occurred and to select the proper emergency procedure. Following is a discussion of some types of tail rotor malfunction and the probable effects therefrom.

(1) Complete Loss of Tail Rotor Thrust. This is a situation involving a break in the drive system, such as a severed drive shaft, wherein the tail rotor stops turning and no thrust whatsoever is delivered by the tail rotor. A failure of this type will always result in the tailboom swinging to the left (left sideslip) and a left roll of the fuselage along the horizontal axis. It is likely that powered flight to a suitable area and execution of an autorotative approach is the proper emergency procedure.

(a) In powered flight the degree of sideslip and the degree of roll may be varied by

changing airspeeds and by varying power (throttle or pitch), but neither can be eliminated. Below an airspeed of approximately 30 to 40 knots, the sideslip angle becomes uncontrollable and the tail of the aircraft begins to revolve on its vertical axis.

(b) In power-off flight (autorotation), the sideslip angle and the roll angle can be almost completely eliminated by maintaining an airspeed of 40 to 70 knots. When airspeed is decreased through approximately 20 to 30 knots, streamlining effect is lost and the sideslip angle becomes uncontrollable. Upon pitch application at touchdown, the fuselage will tend to turn in the same direction the main rotor is turning (tail pylon swings right, opposite torque effect) due to an increase of friction in the

transmission system. When normal control manipulations are used, the deceleration and pitch application should not cause excessive changes in sideslip angle.

(2) Fixed Pitch Setting. This is a malfunction involving a loss of control resulting in a fixed pitch setting, such as a severed control cable. Normally under these circumstances the directional pitch setting that is in the tail rotor at the time the cable is severed will, to some degree, remain in the tail rotor system. Whether the tail pylon hangs left or right is dependent upon the amount of pedal (which is related to power) applied at the time the cable is severed. Regardless of pedal setting at the time of malfunction, a varying amount of tail rotor thrust will be delivered at all times during flight.

(a) If the tail rotor pitch becomes fixed during an approach or other reduced power situation (right pedal applied), the tail pylon will swing left when power is applied, possibly to an even greater degree than would be experienced with complete loss of tail rotor thrust, and the overall situation may be even more hazardous. The best solution may be to autorotate immediately. Whether a successful autorotation could be accomplished is not certain, and is dependent upon the amount of pitch applied at the time of malfunction.

(b) If the tail rotor pitch becomes fixed during a takeoff or other increased power situation (left pedal applied), the tail pylon will swing left when power is reduced (as in leveling off with cruise power). The swing to the right upon power reduction will probably be to a lesser degree than the left swing encountered in any previously mentioned situation. Under these circumstances, it appears that powered flight to an airfield and powered landing could be accomplished with little difficulty since the sideslip angle will probably be corrected when power is applied. Due to sideslip increase upon reduction of power to initiate the approach, a higher than normal approach speed may be beneficial. In this instance, powered landing may be the solution; it is likely that autorotation could not be accomplished at all.

(c) If the tail rotor pitch becomes fixed during normal cruise power settings, the helicopter reaction should not be so violent as in the previously described situations and, at

speeds from 40 to 70 knots, the tail pylon should streamline with very little, if any, sideslip or roll angle. In this instance, autorotation may aggravate the situation because a reduction of power (torque) may then result in a right sideslip. It must be considered, however, that an increase in power at touchdown will result in a left sideslip if powered approach is used, although this sideslip should not be of a hazardous magnitude for touchdown.

(3) Loss of the tail pylon, or portion thereof. The gravity of this situation is dependent upon the amount of weight (how much tail pylon) lost. If the loss is small, such as "aft of the 90° gear-box", the situation would be quite similar to "complete loss of tail rotor thrust". If more than that is lost, immediate autorotation may be the only (if any) solution of possible value.

b. Emergency Procedure For In-Flight Anti-torque Malfunction.

(1) If the situation (altitude) permits, immediately reduce collective pitch (power) as an aid in gaining maximum possible control (trim) of the helicopter under the existing circumstances. Rolling off power (throttle) is not considered necessary at this time.

(2) The pilot should immediately analyze the existing emergency to the best of his ability before taking further action. The courses of action available will normally be —

(a) Autorotate immediately to a secure and improved landing area, if such area is available. This should be accomplished where possible under all circumstances, except as described in paragraph below. The autorotative technique to be used is described in paragraph below.

(b) If a safe landing area is not immediately available, continue powered flight to a suitable landing area by gradually applying power to assume a level powered flight circumstance, with an airspeed dictated by the limitations of the emergency condition. This airspeed should be that which is most comfortable to the pilot between 40 and 70 knots, indicated. When the landing area is reached, make a full autorotative landing, securing the engine (switches off) when the landing area is assured. During the descent, an indicated 60

knots airspeed should be maintained and turns kept to an absolute minimum. If the landing area is a level, paved surface, a run-on landing with a touchdown airspeed between 15 and 25 knots should be accomplished. If the field is unprepared, start to flare from about 75 feet altitude, holding so that forward groundspeed is at a minimum when the helicopter reaches 10 to 20 feet; execute the touchdown with a rapid collective pitch pull just prior to touchdown in a level attitude with minimum ground roll (zero, if possible).

(c) If the pilot has determined that the tail rotor pitch is fixed in a "left pedal applied" position (tail rotor delivering thrust to the left) autorotative landing should not be attempted. The pilot should return to powered level flight at a comfortable airspeed, which will be dictated by the degree of sideslip and roll; continue

powered flight to the nearest improved landing area; and execute a running landing with power and a touchdown speed between 20 and 30 knots. In this approach, the sideslip angle will be corrected, to some degree, when power is applied to cushion the touchdown. However, upon decreasing power to initiate the approach to the landing area, the sideslip angle will increase for the duration of the approach, but should be corrected when touchdown power is applied.

c. Emergency Procedure for Antitorque Malfunction While at a Hover. The best solution for antitorque failure while at a hover is normally to autorotate immediately. However, the exception described in paragraph above still applies. In this instance, gradually reduce pitch to accomplish a powered touchdown.

#### Section IV — Fire

**4-17. Engine Fire During Starting.** An engine fire during starting may be caused by an overloading of fuel in the combustion chamber and a delayed ignition of the fuel resulting in flame emitting from the tailpipe. To extinguish fire, proceed as follows:

a. Throttle — Close and continue to energize starter.

b. FUEL switch — OFF.

c. BATTERY switch — OFF (After fire is extinguished).

**4-18. Engine Fire During Flight.** Immediately enter autorotation and prepare for power-off landing and accomplish the following:

a. Fuel Pressure — CHECK, for abnormal indications.

b. EGT and Engine Oil Pressure — CHECK, for abnormal indication. If engine and systems continue to function normally, land immediately.

c. If engine and systems indicate abnormally, proceed as follows:

(1) Throttle — OFF.

(2) Collective Pitch — Adjust as required to maintain rpm within limits.

(3) Cyclic — Adjust to obtain desired airspeed.

(4) FUEL switch — OFF (if time permits).

(5) Wing Stores — Jettison as appropriate.

(6) Shoulder Harness — LOCKED (if time permits).

(7) BATTERY switch — OFF (unless lights are required).

(8) GENERATOR switch — OFF.

(9) Execute an autorotative landing.

(10) Exit helicopter immediately after shutdown.

**Caution**

After landing, do not attempt to restart engine until cause of fire has been determined and corrected.

**4-19. Fuselage Fire.** In the event of a fuselage fire, proceed as follows:

- a. Airspeed — REDUCE to 40 to 60 KNOTS.
- b. GENERator switch — OFF.
- c. BATtery switch — OFF.
- d. Accomplish landing immediately.
- e. Shutdown immediately after landing.

**Note**

Electrical power required for shutdown.

**4-20. Electrical Fire.** The electrical circuits are individually protected by circuit breakers that automatically interrupt power to aid in the prevention of fire when a short circuit or malfunction occurs. To identify and isolate the defective system, if necessary, proceed as follows:

- a. Instruments — CHECK for correct reading.
- b. BATtery and GENERator switches — OFF.
- c. Circuit Breakers — OUT.
- d. GENERator switch — fwd (ON) if generator circuit is shorted, return generator switch to OFF, and BATtery switch fwd (ON).

e. Circuit Breakers — IN one at a time, and allow a short period of time to identify defective circuit.

**Note**

Flight operation can be maintained without battery and generator; however, most instruments will not function, as they are electrically powered.

**4-21. Wing Stores Fire.** In the event of a fire in the wing stores, proceed as follows:

- a. WG STS JETTISON switch — OUTFD position as appropriate.
- b. WG STS JETTISON switch — INBD position as appropriate.

**4-22. Smoke and Fume Elimination.** Smoke or toxic fumes entering the cabin can be exhausted by the following procedure.

**Caution**

Reduce speed to 40 to 45 knots.

- a. Open pilot's and gunner's canopy doors to an intermediate position.
- b. Vent control — Full open position.

**Note**

If smoke or fumes are caused by an electrical fire, isolate the defective circuit as outlined under ELECTRICAL FIRE.

If smoke concentration is high in the cockpit, the pilot's canopy hatch should be jettisoned while in level flight or a slight climb.

**Section V — Fuel System**

**4-23. Helicopter Fuel Boost Pump Failure.** The helicopter's fuel boost system has two separate fuel boost pumps. Either of the pumps is capable of sustaining normal flight. Upon landing, however, both pumps should be put in working condition before new flight.

**4-24. Engine Fuel Control Malfunction.** Malfunction or failure of the engine fuel control unit will be evident by a loss of power due to lack of fuel or feeding too much fuel into the engine, which will cause a repeated number of loud noises to emit from the tailpipe and will

sound like backfiring. This is called compressor stall. In the event of a control unit malfunction or failure, proceed as follows:

- a. Collective Pitch — Adjust to maintain rotor rpm.
- b. Throttle — RETARD TO FLIGHT IDLE.
- c. GOVERNOR switch — EMERGENCY position.
- d. Throttle—ADVANCE slowly and smoothly to obtain engine operating rpm.

**Warning**

When operating on the emergency fuel system, the throttle must be manually adjusted to maintain engine rpm. Throttle movement shall be performed at a slower rate to minimize the possibility of flameout or compressor stall.

**4-25.** The engine fuel system is as near fail-safe as possible, because the fuel pump is a dual element unit, either element is capable of supplying engine fuel requirements. Failure of one pump element will illuminate the master caution light and the caution panel ENG FUEL PUMP warning light.

**Section VI — Electrical System**

**4-26. Electrical Power System Failure.** Complete failure of the electrical system is improbable because the primary dc power normally supplied by the generator will be furnished by the battery in the event of a generator failure. Evidence of generator failure will be provided by illumination of the DC GENERATOR fault light and the MASTER CAUTION light. If the generator has not failed and the circuit has opened, reset as follows:

- a. GEN BUS RESET circuit breaker— Check in.

- b. GEN FIELD circuit breaker — Check in.

- c. GEN switch — Move to RESET then to GEN position.

**4-27. AC Inverter Failure.** Failure of the inverter will be evident by illumination of the master caution light and the INST INVTR fault light on the caution panel. In the event of an inverter failure, check the INVERTER PWR circuit breaker by pushing IN. Position INVERTER switch to STBY position.

**Section VII — Hydraulic System**

**4-28. Hydraulic System.** Due to the higher control loads of the 540 rotor, a dual hydraulic system has been deemed necessary. A failure of either system is of little consequence as the controls are readily moved. A dual hydraulic failure is much more serious and should be treated as an emergency. Procedures for the three combinations of hydraulic failure are described in the following paragraphs.

**4-29. System No. 1 Failure.** a. EMERGENCY COLLECTIVE HYDRAULIC switch (located on instrument panel) —OFF, to prevent depletion of the accumulator.

- b. SAS — Disengage YAW channel.

- c. Land helicopter as soon as practical.

**Note**

Loss of the No. 2 hydraulic system will result in stoppage of the TAT-102A automatic gun and loss of pitch and roll SAS actuators. The TAT-102A turret will return to the stow position in elevation; however, it will not stow in azimuth. Cyclic and collective control feedback may be evident during abrupt maneuvers.

**4-30. System No. 2 Failure.** a. EMERgency Col-  
lective HYDraulic switch (located on instru-  
ment panel) — OFF, to prevent depletion of the  
accumulator.

- b. SAS — Disengage pitch and roll channels.
- c. Land helicopter as soon as practical.

**4-31. System No. 1 and No. 2 Failure.** a. EMER-  
gency COLLECTive HYDraulic switch — OFF, to  
prevent depletion of the accumulator.

**Warning**

If, following loss of both hydraulic sys-  
tems, an immediate landing is planned,  
check that EMERgency COLLECTive  
HYDraulic switch is ON. The decision  
to land immediately should be based on  
the ability to make a flat, straight  
ahead approach, the availability of a  
surface for a touch down of 20 to 25  
knots airspeed and the amount of sup-  
port equipment and personnel at the  
landing site.

Cyclic forces increase abruptly below  
20 knots airspeed.

b. SAS — Disengage all channels.

c. Airspeed — Maintain speed where control  
forces are manageable.

**Note**

Loss of both hydraulic systems will  
result in loss of the SAS actuators,  
cyclic, collective and tail rotor boost  
and stoppage of the TAT-102A auto-  
matic gun. The turret will return to  
the stow position in elevation; how-  
ever, it will not stow in azimuth.

**Caution**

Normal position of the EMERgency  
COLLECTive HYDraulic switch is OFF.  
In the event of a dual hydraulic  
failure, the switch may be momen-  
tarily moved to the ON position to  
adjust collective position, if neces-  
sary and then to the OFF position.  
On final approach, the switch should be  
moved to the ON position and collec-  
tive motion kept to a minimum until  
near touchdown, so that sufficient col-  
lective control remains to accomplish  
a run-on landing. In event the collec-  
tive accumulator is depleted before  
landing is made, it is recommended  
that touchdown airspeed be a mini-  
mum of 35 knots.

d. Wing Stores Jettison.

- (1) Actuate switch to OUTBD position.
- (2) Actuate switch to INBD position.

e. Select a landing site as soon as practical.

**Section VIII — Landing And Ditching**

**4-32. Emergency Descent.** The power off  
minimum rate of descent is obtained by main-  
taining a forward speed glide of approximately  
55 to 65 knots, dependent on gross weight and  
altitude.

**4-33. Emergency Landing.** Emergency land-  
ings can be accomplished without undue diffi-  
culty. They are executed in near the same man-

ner as a power-on landing. The portion of the  
procedure which is different is the final touch-  
down which will be easier to perform with a  
slight forward speed at time of contact. It  
should be remembered that landing distance  
(ground roll) is limited by the skid type landing  
gear and ground surface condition. Refer to  
ENGINE FAILURE DURING FLIGHT pro-  
cedure contained in this Chapter.



**Note**

Loss of the No. 2 hydraulic system will result in stoppage of the TAT-102A automatic gun and loss of pitch and roll SAS actuators. The TAT-102A turret will return to the stow position in elevation; however, it will not stow in azimuth. Cyclic and collective control feedback may be evident during abrupt maneuvers.

**4-30. System No. 2 Failure.** a. EMERgency Col-  
lective HYdraulic switch (located on instru-  
ment panel) — OFF, to prevent depletion of the  
accumulator.

- b. SAS — Disengage pitch and roll channels.
- c. Land helicopter as soon as practical.

**4-31. System No. 1 and No. 2 Failure.** a. EMER-  
gency COLlective HYDraulic switch — OFF, to  
prevent depletion of the accumulator.

**Warning**

If, following loss of both hydraulic sys-  
tems, an immediate landing is planned,  
check that EMERgency COLlective  
HYDraulic switch is ON. The decision  
to land immediately should be based on  
the ability to make a flat, straight  
ahead approach, the availability of a  
surface for a touch down of 20 to 25  
knots airspeed and the amount of sup-  
port equipment and personnel at the  
landing site.

Cyclic forces increase abruptly below  
20 knots airspeed.

b. SAS — Disengage all channels.

c. Airspeed — Maintain speed where control  
forces are manageable.

**Note**

Loss of both hydraulic systems will  
result in loss of the SAS actuators,  
cyclic, collective and tail rotor boost  
and stoppage of the TAT-102A auto-  
matic gun. The turret will return to  
the stow position in elevation; how-  
ever, it will not stow in azimuth.

**Caution**

Normal position of the EMERgency  
COLlective HYDraulic switch is OFF.  
In the event of a dual hydraulic  
failure, the switch may be momen-  
tarily moved to the ON position to  
adjust collective position, if neces-  
sary and then to the OFF position.  
On final approach, the switch should be  
moved to the ON position and collec-  
tive motion kept to a minimum until  
near touchdown, so that sufficient col-  
lective control remains to accomplish  
a run-on landing. In event the collec-  
tive accumulator is depleted before  
landing is made, it is recommended  
that touchdown airspeed be a mini-  
mum of 35 knots.

d. Wing Stores Jettison.

- (1) Actuate switch to OUTBD position.
- (2) Actuate switch to INBD position.

e. Select a landing site as soon as practical.

**Section VIII — Landing And Ditching**

**4-32. Emergency Descent.** The power off  
minimum rate of descent is obtained by main-  
taining a forward speed glide of approximately  
55 to 65 knots, dependent on gross weight and  
altitude.

**4-33. Emergency Landing.** Emergency land-  
ings can be accomplished without undue diffi-  
culty. They are executed in near the same man-

ner as a power-on landing. The portion of the  
procedure which is different is the final touch-  
down which will be easier to perform with a  
slight forward speed at time of contact. It  
should be remembered that landing distance  
(ground roll) is limited by the skid type landing  
gear and ground surface condition. Refer to  
ENGINE FAILURE DURING FLIGHT pro-  
cedure contained in this Chapter.

**Note**

When anticipating a crash landing or ditching and time permitting—Jettison wing stores—locking of the shoulder harness provides an added safety precaution over that of the automatic lock.

**4-34. Landing in Trees.** A power-off landing into heavily wooded area can be accomplished by executing a normal autorotative approach and full flare. The flare should be executed so as to reach zero rate of descent and zero ground speed as close to the top of the trees as possible. As the helicopter settles, increase collective pitch to maximum.

**4-35. Emergency Entrance and Exit.** To gain entrance to the crew compartment, break and/or open canopy hatches and canopy glass. Pull jettisonable releases and remove canopy hatch.

**4-36. Ditching With Engine Power ON.** The pilot's decision to ditch is accomplished in the following manner.

- a. Inform Gunner of intentions.
- b. Wing Stores — Jettison as appropriate.
- c. Airspeed — Hover, in ground effect.
- d. Canopy Hatches — Jettison (Pilot and Gunner).

- (1) Rotate door handle up.
- (2) Rotate jettison handle inboard.
- (3) Push door out.

**Note**

Hover away from hatches and have gunner exit helicopter. Loss of 200 pound gunner will result in a CG shift of 2.5 to 4.0 inches.

- e. SAS — OFF.
- f. MASTER ARM switch — OFF.
- g. BATTERY switch — OFF.

- h. Shoulder Harness — LOCKED.

**Note**

Hover away from gunner.

- i. Throttle — OFF.
- j. Accomplish a hovering autorotation and attempt to roll the helicopter to the left.
- k. Exit helicopter when main rotor stops.

**4-37. Ditching With Power OFF.** Perform an autorotative glide into the wind, by a coordinated movement of the controls, and an airspeed of approximately 60 to 70 knots.

- a. Wing Stores — Jettison as appropriate.
- b. Inform gunner of intentions and inform him to jettison his canopy hatch when the water is contacted.

- (1) Rotate door handle up.
- (2) Rotate jettison handle inboard.
- (3) Push door out.

- c. Shoulder Harness — LOCKED (Pilot and Gunner).

- d. SAS — OFF.
- e. MASTER ARMament switch — OFF.
- f. Throttle — OFF.
- g. BATTERY switch — OFF.

- h. Execute an autorotative landing and attempt to roll the helicopter to the left.

**Note**

Pilot should jettison his canopy prior to contact with water or as the situation allows.

**Section IX — Flight Controls**

**4-38. Flight Control Failure.** The flight control system is a mechanical type with hydraulic servo cylinders connected into the fore and aft cyclic, lateral cyclic, collective and the directional control system. The servo cylinders are installed solely to reduce control forces and lessen pilot fatigue. The design of the control

system's mechanical linkage is sturdy, control movements are positive and the possibility of failure is remote; therefore, an emergency system has not been provided. See hydraulic system failure (Section VII) for hydraulic system failure data. See SAS system failure (Section XII) for SAS system failure data.

**Section X — Bail Out**

**4-39. Bail Out.** Helicopter design, flight characteristics and autorotation qualities reduce the necessity for bail out, however, if a decision is made to bail out, accomplish as follows:

- a. Warn gunner of intent.
- b. Reduce airspeed to approximately 20 knots, if canopy hatches are to be jettisoned.
- c. Jettison canopy hatches.
  - (1) Rotate door handle up.

- (2) Rotate jettison handle inboard.
- (3) Push door out.
- d. Set controls to establish cruise forward speed, nose slightly down, flight attitude.
- e. Bail out when ready.

**Warning**

Delay opening of parachute until well clear of helicopter.

**Section XI — Emergency Jettisoning**

**4-40. Wing Stores Emergency Jettison.** The pilot is provided with electrical jettisoning and emergency electrical jettisoning. The gunner is provided with emergency electrical jettisoning. An emergency jettison switch is located on each instrument panel. To jettison: Wing Stores Jettison switch — UP position.

**Note**

Emergency Jettison operates with battery switch in either position.

The emergency jettison circuit contains a time delay for the inboard stores. The outboard stores are jettisoned first and the inboard stores are jettisoned one-half second later.

**Section XII — Stability Augmentation System**

**4-41. Stability Augmentation System (SAS) Failure.** Hardover failure of a Stability Augmentation System Actuator. A hardover failure of a SAS Actuator will be evident by an abrupt change in pitch, roll or yaw attitude which, when corrected by the pilot will result in an abnormal cyclic or pedal position. If a hardover failure occurs, proceed as follows:

- a. Controls — Adjust to obtain a level flight, zero sideslip condition.
- b. Airspeed — Adjust to a value below the speed for maximum level flight speed.

- c. SAS disengage button — Press.

**Note**

Steps a. through c. may be accomplished simultaneously. After aircraft attitude and airspeed control has been re-established, the pilot may re-engage the unaffected SAS channels, if desired. Airspeed limits with the SAS OFF are the same as with SAS ON and the decision to continue the flight with any or all of the channels disengaged is dependent upon the pilot's experience.

CHAPTER 5  
AVIONICS

Section I — General

**5-1. Scope.** The purpose of this Chapter is to describe the electronic equipment installed in the helicopter. It includes a brief description of the equipment, its purpose, capabilities and location. The Chapter also contains complete operating instructions for all avionic equipment installed in the helicopter.

**5-2. Nomenclature and Common Names.** A list of the avionic equipment installed in the helicopter, with a common name assignment for each piece of equipment, is presented in Table 5-1.

Table 5-1. Nomenclature and common names

<u>NOMENCLATURE</u>	<u>COMMON NAME</u>
Intercommunications Set C-1611/AIC	Interphone Panel
Radio Set AN/ARC-51BX Receiver — Transmitter RT 742/ARC-51BX Control Panel C-6287/ARC-51BX Antenna AT-1108/ARC	UHF Command Set Receiver-Transmitter UHF Control Panel UHF Antenna
Radio Set AN/ARC-54 Receiver-Transmitter RT-348/ARC-54 Control Panel C-3835/ARC-54 FM Homing Antenna FM Communications Antenna-Collins 437S-1 Indicator ID-48( )/ARN	FM Radio Set Receiver-Transmitter FM Control Panel Homing Antenna FM Antenna Course Indicator
Radio Set Wilcox 807A Receiver-Transmitter 97607-101 Control Panel 97733-100 Antenna AT-1108/ARC	VHF Radio Set Receiver-Transmitter VHF Control Panel VHF Antenna
ADF Receiving Set AN/ARN-83 Receiver R-1891/ARN-83 Control Panel C-6899/ARN-83 Antenna Collins Type 137A-7 Antenna 209-030-133	Direction Finder Set ADF Receiver ADF Control Panel Loop Antenna Sense Antenna
Transponder Set AN/APX-44 Receiver-Transmitter, Radar RT-494/APX-44 Transponder Set Control C-2714/APX-44 Antenna AT-884/APX-44	Transponder Set Receiver-Transmitter Control Panel Antenna
AN/ASN-43 Compass Transmitter Induction Compass T-611/ASN Compensator, Magnetic Flux CN-405/ASN Directional Gyro CN-998/ASN-43 Amplifier Electronic Control AM-3209/ASN Indicator Radio Magnetic Compass ID-988/ASN Indicator Radio Magnetic ID-250/ARN	Gyromagnetic Compass Flux Valve Compensator Directional Gyro Amplifier, Servo RMI RMI

Section II — Description and Data

**5-3. Purpose and Use.** The purpose and use of the communication and navigation equipment installed in the helicopter is described in the following paragraphs:

**5-4. Signal Distribution Panel.** The signal distribution panel is a transistorized unit used for intercommunication between the pilot and gunner. The set also amplifies all received or transmitted audio signals to or from other communication and navigation receivers and transmitters. It is used to monitor the communications and navigation receivers singly or in combination. Both intercom stations are connected for full transmit and receive facilities for all communication and navigation equipment. A hot mic is also provided at each station for intercom operation without the use of an external key.

**5-5. UHF Command Set.** The UHF Radio Set provides two-way amplitude modulated voice communications between aircraft in flight, aircraft and ship and aircraft and ground stations. The set operates in the UHF (Ultra High Frequency) band of 225.0 to 399.9 mc. It tunes in 0.05 mc increments and provides 3500 channels. A preset channel selector and 20 preset channels are provided. The set provides monitoring of the guard channel. Transmission and reception are conducted on the same frequency with the use of a common antenna.

**5-6. FM Radio Set.** The FM Radio provides two-way voice communications between aircraft in flight and aircraft and ground stations within the tactical frequency modulation (FM) range of 30.0 to 69.9 mc. In addition to voice communication, the FM radio permits selective calling (TONE) operation. Also when used with the homing antenna and course indicator, the pilot is provided with a homing facility. This permits homing on any station within the 30.0 to 69.9 mc frequency range.

**5-7. VHF Radio Set.** The VHF Radio Set provides voice communication between aircraft in flight and aircraft and fixed or mobile ground stations. It operates in the very high-frequency (VHF) range of 116.000 through 149.975 mc. This provides 1360 channels spaced 25 kc apart. The set transmits and receives amplitude modulated signals on the same frequency with the use of a common antenna.

**5-8. Direction Finder Set.** The direction finder set provides radio aid to navigation. It operates in the frequency range of 190 to 1750 kc. When operating as an automatic direction finder, the system presents a continuous indication of the bearing to any selected radio station. It also provides simultaneously aural reception of audio from the station. When the manual mode of operation is selected, the system enables the operator to find the bearing to any selected radio station by manually controlling the null direction of the directional antenna. The system also operates as a radio range receiver and a conventional low-frequency aural receiver to receive voice and unmodulated transmission.

**5-9. Gyro Magnetic Compass.** The gyro magnetic compass is a direction sensing system which provides a visual indication of the magnetic heading of an aircraft with respect to the magnetic meridian and/or horizontal component of the earth's magnetic field. The information which the system supplies may be used for navigation and to control the flight path of the aircraft. The system may also be used as a free gyro in areas where the magnetic reference is unreliable.

**5-10. Transponder Set.** The Transponder Set receives, decodes and responds to interrogations of the Mark X Identification Friend or Foe (IFF) System supplemented by Selected Identification Features (SIF) and to the interrogation of civil secondary ground radar systems. The transponder set can also be used to transmit specially coded emergency signals or position-identifying signals, even though the set is not being interrogated by a ground based IFF system.

**5-11. Interrogating Signals,** consisting of pairs of pulses spaced to form a code, are transmitted to the transponder, which decodes the interrogation and transmits a coded reply to the question source. The form of coded reply, which can be preset by the transponder set controls, presents positive identification of the nationality and position of the helicopter.

**5-12.** The operational facilities of the transponder set are divided into five categories, each of which may be selected by the pilot. These categories are as follows:

Normal Operation  
Modified (SIF) Operation  
Civil Operation  
Position Identification  
Emergency Operation

**5-13.** Three independent coding modes, or combinations of the three, are available to the pilot. Mode 1 provides 32 possible code combinations, any one of which may be selected while in flight. Mode 2 provides one code combination which is preset prior to flight and may consist of any one of 4,096 possible code combinations. Mode 3 provides 64 additional code combinations, any one of which may be selected by the pilot while in flight.

**5-14. Technical Characteristics.** The technical characteristics of the electronic equipment installed in the helicopter are listed in the following paragraphs. Table 5-2 is a complete listing of the communication and associated electronic equipment installed in the helicopter.

**5-15. UHF Command Set.**

Frequency range 225.0 to 399.9 mc  
Number of channels and spacing 3500 channels, spaces 50 kc  
Modes of operation AM voice  
Type of modulation Amplitude

**Table 5-2. Communications and associated electronic equipment**

FACILITY	NOMENCLATURE	USE	RANGE	LOCATION OF CONTROLS
UHF Command Communications	Radio Set AN/ARC-51BX	Two-way Voice Communications in the frequency range of 225.0 to 399.9 mc	Line of Sight or 50 miles average	Pilot's Station
FM Liaison Communications	Radio Set AN/ARC-54	Two-way Voice Communications in the frequency range of 30.00 to 69.95 mc	Line of Sight or 80 miles average conditions	Pilot's Instrument Panel
VHF Communications	Radio Set Wilcox 807-A	Two-way Voice Communications in the frequency range of 116.00 to 149.95 mc	Line of Sight or 50 miles average conditions	Gunner's Instrument Panel
Inter-Communication	Radio Set C-1611A/AIC	Interphone for Pilot and Gunner; Integrates all Communication Equipment	Stations Within Helicopter	Pilot's and Gunner's Left Instrument Panel Cyclic Stick Grips
FM Homing	Radio Set AN/ARC-54 Used with FM Homing Antenna	Homing on FM Transmission within frequency range of 30.00 to 69.95 mc	80 miles average conditions.	Pilot's Instrument Panel
Automatic Direction Finding	Direction Finder Set AN/ARN-83	Radio Range and Broadcast Reception; Automatic Direction Finding and Homing in the Frequency Range of 190 to 1750 kc	150 or 200 mlie average, depending on terrain interference and noise	Pilot's Console
Magnetic Heading Indications	AN/ASN-43	Navigational Aid		Pilot's Instrument Panel
Identification	Transponder Set AN/APX-44	Transmits a specially coded reply to ground based IFF radar interrogator system	Line of Sight	Pilot's Console

**5-16. FM Radio Set.**

Frequency range	30.00 to 69.95 mc
Number of channels and spacing	800 channels, spaces 50 kc
Modes of operation	FM voice or homing
Type of modulation	Frequency
Distance range	80 miles (average conditions)

**5-17. VHF Radio Set.**

Frequency Range	116.00 through 149.975 mc
Number of channels and spacing	1360 channels, spaces 25 kc
Modes of operation	AM voice
Type of modulation	Amplitude
Altitude range	45,000 feet maximum

**5-18. Direction Finder Set.**

Frequency range:	
Band 1	190 kc to 400 kc
Band 2	400 kc to 850 kc
Band 3	850 kc to 1,750 kc
Modes of operation	Automatic direction finding and aircraft homing
Distance range	Long range

**5-19. Transponder.**

Frequency range:	
Receiver	1030 mc
Transmitter	1090 mc
Types of signals received and transmitted	Pulsated radio frequency
Interrogation rates	15 to 500 per second (normal)
Range	Line of sight

**5-20. Description of Configuration.** The avionic configuration of the helicopter consists of: Two signal distribution panels, headset cordages and keying switches. Additional equipment includes: A UHF radio set, FM radio set, automatic direction finder and a gyrosyn compass. The keying switch is the hat switch on top of the cyclic control grips in both stations. Placing the hat switch in aft position keys the interphone. The forward position of the switch keys the radio selected with transmit-interphone selector switch on the interphone panel. In addition to the hat switch, the gunner has

a foot switch. The foot switch has only one position. It keys the radio or interphone that is selected with the transmit-interphone selector switch on the gunner's signal distribution panel. The gunner's headset cordage connector is aft of the cyclic stick and just forward of the canted bulkhead. The pilot's headset cordage connector is on his left, outboard from the collective control stick. The UHF radio, FM radio and automatic direction finder have only one control panel, which is located in the pilot's station. The UHF radio control panel is located on the pilot's instrument panel. The automatic direction finder control panel is installed in the pilot's right console.

**5-21.** The helicopter's avionic equipment also includes a transponder set and VHF radio set. The transponder control panel is in the pilot's right console. The VHF radio control panel is in the gunner's instrument panel. The FM radio control panel is in the pilot's instrument panel. This configuration has the FM homing facility, and also has external interphone receptacles located in each wing tip. Headset cordages with in-the-line keying switches for adapting the headset to the wing tip receptacles are provided.

**5-22. Description of Components.** The components of the radio sets and electronic equipment installed in the helicopter are described in the following paragraphs:

**5-23. UHF Command Set.** The UHF Command Set includes a receiver-transmitter installed in the tail boom section, a remote control unit installed in the pilot's compartment and a UHF antenna (see figure 5-1) installed inside the forward pylon fairing.

a. The receiver is a pressurized unit. Internal air is cooled by heat exchangers and an externally mounted blower. The blower operates only when the internal temperature of the receiver-transmitter exceeds 95°F. Primary power to operate the set is supplied from the 28-volt dc essential bus. Circuit protection is provided by a circuit breaker marked UHF COMM. The receiver-transmitter is controlled from the UHF remote control panel mounted in the pilot's instrument panel. For description of the control panel, refer to paragraph 5-30.

b. The UHF/VHF antenna is a dual antenna contained in a single housing. Both UHF and

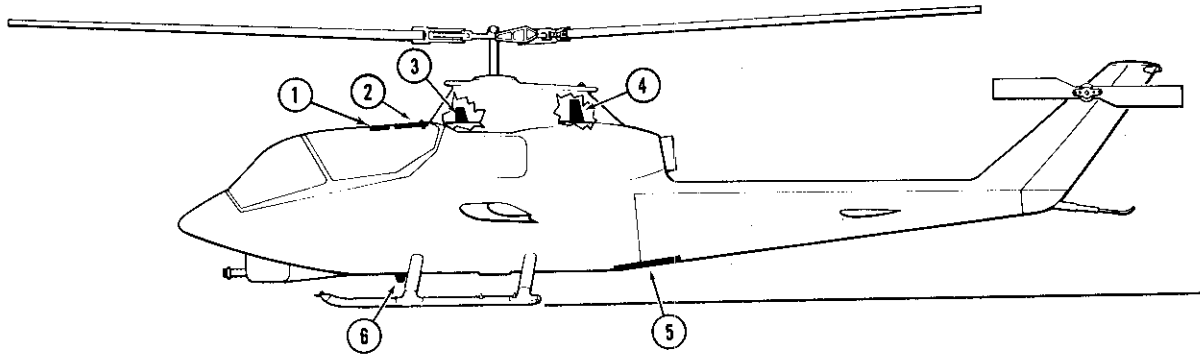

1. AN/ARC-54 Homing Antenna  
2. ARN-83 Loop Antenna

3. AT-1108/ARC UHF - VHF  
Communications Antenna  
4. AN/ARC-54 Communication  
Antenna

5. AN/ARN ADF Sense Antenna  
6. AT-884/APX-44 IFF Antenna

209078-15B

Figure 5-1. Antenna location

VHF antenna elements and connectors are provided which permits the antenna to be used for either UHF, VHF or both.

**5-24. FM Radio Set.** The FM Radio Set includes a receiver-transmitter, FM control panel, communications antenna, homing antenna, and homing (course) indicator.

a. The FM Receiver-Transmitter is installed (in the tail boom section) and is controlled from the FM control panel at the pilot's station. For description of the control panel, refer to paragraph 5-32. Primary power to the radio set is supplied from the helicopter 28-volt dc non-essential bus. Circuit protection is provided by a circuit breaker marked FM RCVR.

b. The FM communication antenna (see figure 5-1) consists of an antenna element, mounting base and coupler, which are installed above the engine, inside the pylon fairing.

c. The homing antenna (see figure 5-1) is installed in the cabin roof plexiglass panel. Data provided by the homing facility is displayed visually on the course indicator in the pilot's instrument panel. For description of the course indicator, refer to paragraph 5-33.

**5-25. VHF Radio Set.** The VHF Radio Set consists of a receiver-transmitter, remote control

panel, and VHF antenna. The receiver-transmitter is installed in the tail boom section. The control panel for the receiver-transmitter is installed in the gunner's instrument panel. For description of the panel, refer to paragraph 5-31. The VHF antenna is contained in the same housing with the UHF antenna and is installed inside the forward pylon fairing (see figure 5-1). Primary power to operate the radio set is supplied from the 28-volt dc non-essential bus. Circuit protection is provided by a circuit breaker marked VHF COMM.

**5-26. Direction Finder Set.** The direction finder set consists of a receiver, a control panel, a loop antenna, a sense antenna, and two indicators.

a. The receiver is a three-band transistorized unit, mounted in the aft fuselage electrical compartment, forward of the tail boom. Primary power to operate the receiver is supplied from the 28 volt dc non-essential bus. The receiver is controlled from a remote control panel mounted in the pilot's right console. For description of the control panel, refer to paragraph 5-34.

b. The loop antenna and sense antenna are part of the direction finder system. The loop antenna is installed above the cabin roof (see figure 5-1). The sense antenna is in one section and is an integral part of the bottom fuselage skin.



c. Information received via the direction finder set is presented visually on the pilot's and gunner's radio magnetic indicators and aurally through the intercom system. For description of the radio magnetic indicators, refer to paragraph 5-35.

**5-27. Gyro Compass AN/ASN-43.** The AN/ASN-43, Compass System consists of a flux valve, gyro and amplifier and two radio magnetic indicators.

a. The compass transmitter or flux-valve is installed in the tail boom. It is the direction sensing unit of the compass system. The unit consists of a hemispherical bowl, which houses the functioning assemblies, and is attached to a mounting flange and compensator.

b. A sealed directional gyroscope and electronic amplifier are mounted on the same base and installed in the aft electrical compartment. The gyro contains automatic leveling circuits and precession coils for slaving the gyro to the magnetic reference in the slaved mode. The precession coils are used in the free gyro mode to provide latitude corrected drift. Primary 115-volt ac power is supplied from the helicopter ac

circuit breaker panel to a power supply in the base. This power supply then, supplies power to operate the gyro and amplifier and to excite the transmitter. The base also contains a relay operated by the COMPASS SLAVING switch to switch operation from the free gyro mode to the slaved mode. For description of the radio magnetic indicators, refer to paragraph 5-35. The COMPASS SLAVING switch is described in paragraph 5-36.

**5-28. Transponder Set.** The transponder set consists of a receiver-transmitter and mounting, a remote control and antenna.

a. The receiver-transmitter is installed in the tail boom section. The set is controlled from the transponder control panel installed in the pilot's right console. For description of the control panel refer to paragraph 5-37. Primary power to operate the set is supplied from the 28-volt dc essential bus.

b. The antenna (see figure 5-1) used with the transponder set is a light weight blade type. It is installed beneath the pilot's station on the fuselage.

### Section III — Operating Controls

**5-29. Signal Distribution Panel.** This panel (see figure 5-2) is marked INT (interphone). Two of the panels are installed in the helicopter. The pilot's panel is in left console, and gunner's panel is in the instrument panel. The system is used for intercommunication and radio control. It may be used in any one of three different modes as determined by the setting of the switches and controls on the panel. The three modes of operation are: Two-way radio communication, radio receiver monitoring and intercommunication between the pilot and gunner. The switches and controls located on the panel and their function are as follows:

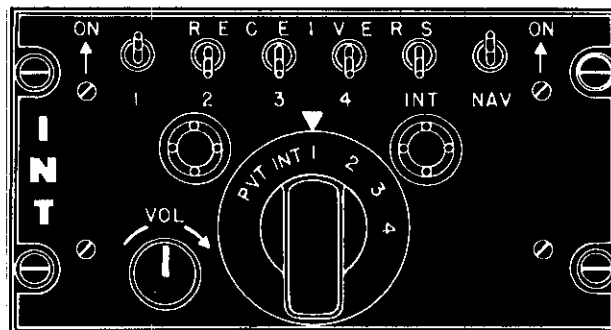

205475-34

Figure 5-2. Signal distribution panel

<u>CONTROL</u>	<u>FUNCTION</u>
RECEIVERS switches 1, 2, 3 and 4	Turns audio from associated receiver ON or OFF.
INT switch	ON position enables operator to hear audio from the interphone
NAV switch	ON position enables operator to monitor audio from the navigation receiver.
VOL control	Adjusts audio on receivers except NAV receivers
Transmit-interphone selector switch	Positions 1, 2, 3, 4 and INT connect INT or associated receiver-transmitter for transmit and receive function. Hat switch or foot switch must be used to transmit. PVT position keys interphone for transmission without the use of an internal switch.

<u>CONTROL</u>	<u>FUNCTION</u>
	T/R plus G — Permits transmission and reception; guard receiver is operative.
	ADF — Not applicable.
VOL control	Controls audio level.
SQ DISABLE switch	ON — Squelch is disabled.  OFF — Squelch is operative.
Mode selector switch	Determines the manner in which the frequencies are selected as follows:  PRESET CHAN — permits selection of one of 20 preset channels by means of preset channel control.

**5-30. UHF Control Panel.** This Control Panel (see figure 5-3) is marked UHF and is installed in the pilot's station. It is used to control the UHF Radio Set. The controls located on the panel and their functions are as follows:

<u>CONTROL</u>	<u>FUNCTION</u>
Function select switch	Applies power to the set and selects type of operation as follows:  OFF—Removes power from the set.  T/R—Applies power to set and permits transmission and reception; guard receiver is not operative.

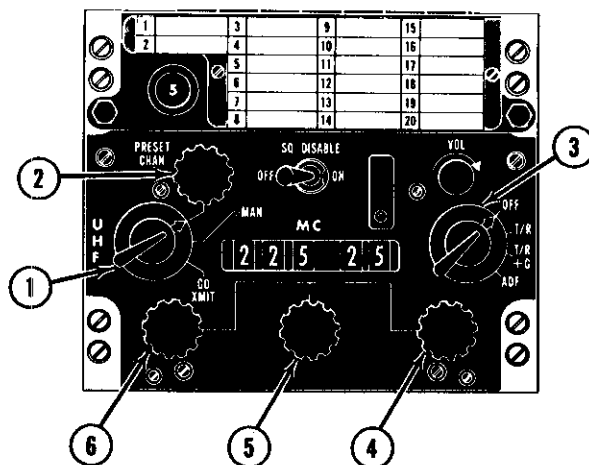

1. Mode Selector
2. Preset Channel Control
3. Function Select Switch
4. 0.05 Megacycle Control
5. 1 Megacycle Control
6. 10 Megacycle Control

205475-30

Figure 5-3. UHF control panel

<u>CONTROL</u>	<u>FUNCTION</u>
	MAN — Permits frequency selection by means of megacycle controls.
	GD XMIT — Receiver-transmitter — automatically tunes to guard channel.
PRESET CHAN	Permits selection of one of 20 preset channels.
Preset channel indicator	Indicates preset channel selected.
Ten megacycle control	Selects first two digits of operating frequency
One megacycle control	Selects the third digit of operating frequency
Five-hundredths megacycle control	Selects fourth and fifth digits of operating frequency

**5-31. VHF Control Panel.** This control panel (see figure 5-4 ) is marked VHF COMM and installed in the gunner's instrument panel. It is used to control the VHF Radio. The controls located on the panel and their functions are as follows:

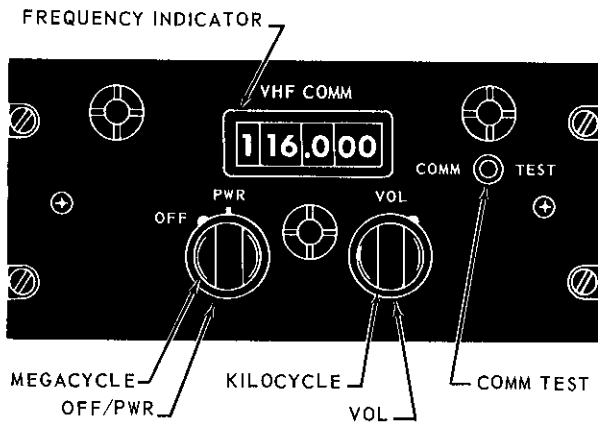

209078-17

Figure 5-4. VHF control panel

<u>CONTROL</u>	<u>FUNCTION</u>
OFF-PWR switch	Turns power to the set ON-OFF
VOL control	Adjusts audio level
COMM — TEST switch	Turns squelch on or off
Megacycle control	Selects whole number part of operating frequency.
Kilocycle control	Selects the decimal number part of operating frequency.

**5-32. FM Control Panel.** The FM panel (see figure 5-5) is marked FM COMM. The panel is installed in the pilot's instrument panel. It is used to control the FM Transceiver. The controls located on the panel and their functions are as follows:

<u>CONTROL</u>	<u>FUNCTION</u>
Mode selector	Selects mode of operation as follows:  OFF—Turns off power. PTT — Applies power  RETRAN — Not applicable  HOME — Connects set to homing antenna and course indicator for homing.
VOL control	Adjust audio level
SQUELCH control	Selects squelch mode as follows:  DIS — Squelch disabled CARR—Squelch operative TONE — Squelch opens only on signals containing 150 cps tone modulation.

<u>CONTROL</u>	<u>FUNCTION</u>
Whole megacycle control	Selects the whole-megacycle digits of the operating frequency
Decimal megacycle control	Selects the decimal megacycle digits of the operating frequency

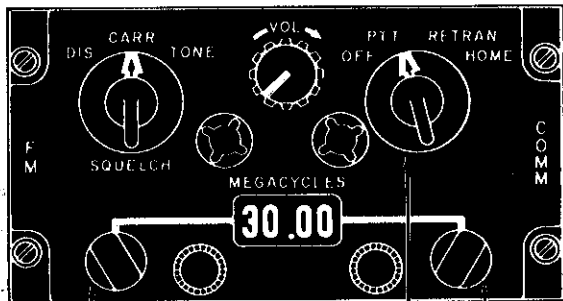

1. Frequency Control Whole - Megacycle
2. Mode Selector Switch
3. Frequency Control Decimal - Megacycle

5-33

Figure 5-5. FM control panel

**5-33. Course Indicator.** The course indicator (see figure 5-6) is located in the pilot's instrument panel. This indicator is used only when the FM Radio is operating in the homing mode. The indicating elements in the indicator and their functions are as follows:

<u>INDICATOR OR CONTROL</u>	<u>FUNCTION</u>
OFF vertical flag	Disappears from view when FM homing circuits are functioning properly. Remains in view when FM homing circuits are not functioning properly.
OFF horizontal flag	Disappears from view when FM homing cir-

<u>CONTROL OR INDICATOR</u>	<u>FUNCTION</u>
-----------------------------	-----------------

Horizontal pointer	Indicates strength of FM homing signal being received. Deflects downward when flying over station being received, when flying away from station or when signal is unreliable.
Vertical pointer	Pointer is in center position when aircraft is flying toward or directly away from the FM homing station being received.
Marker beacon light	Not used.

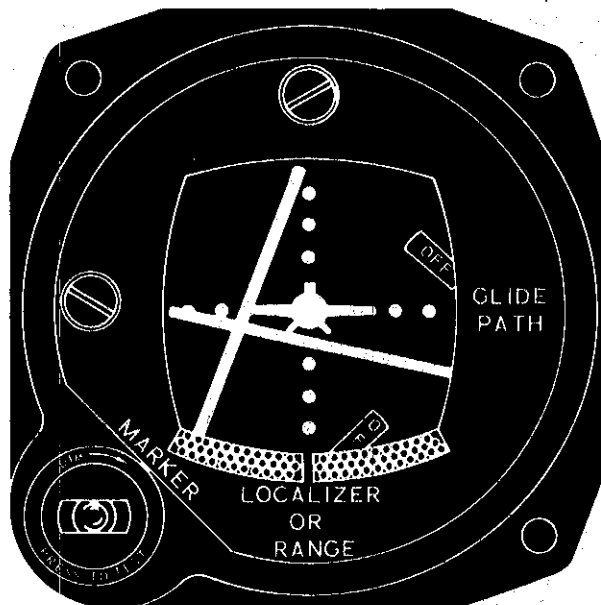

209475-1

Figure 5-6. Course indicator

**5-34. ADF Control Panel.** This panel (see figure 5-7) is marked ADF and is located in the pilot's right console. The panel is used to control the direction finder set and associated loop antenna and to select the sense antenna. The controls and indicators located on the panel and their functions are as follows:

<u>CONTROL</u>	<u>FUNCTION</u>
Band selector switch	Selects the desired frequency band
Tune control	Selects the desired frequency
Tuning meter	Facilitates accurate tuning of the receiver
GAIN control	Adjusts audio level
LOOP L-R switch	Rotates loop antenna to the right or left
BFO switch	Turns BFO, on or off

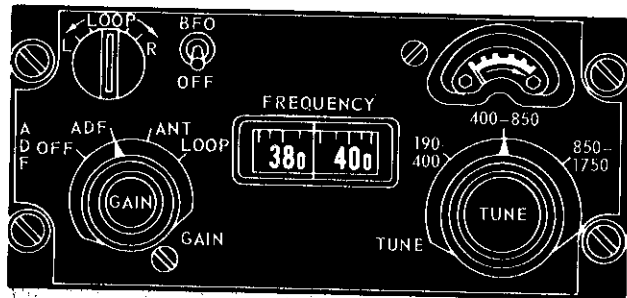

Figure 5-7. ADF control panel.

**5-35. Radio Magnetic Indicator.** A radio magnetic indicator (see figure 5-8) is installed in the pilot's instrument panel. A second radio magnetic indicator (not shown) is installed in the gunner's instrument panel. The gunner's indicator is a repeater type instrument similar to the pilot's indicator except that it has no control knobs. The moving dial on both indicators displays the gyro magnetic compass heading. Both pointers on the indicators indicate the bearing to the station selected on the ADF receiver. The controls located on the radio magnetic indicators and their functions are as follows:

CONTROL OR INDICATOR

FUNCTION

ADF/VOR knob	Selects ADF or VOR, however, only ADF is used on this installation, therefore, switch should remain in ADF position.
Fixed Index	Provides reference mark for rotating dial.
Rotating scale dial	Rotates under fixed index to indicate aircraft heading.
Annunciator	Shows dot (.) or cross (+) to indicate misalignment (non-synchronization of compass system).
Pointer No. 1	Indicates bearing of ADF radio signal.
Pointer No. 2	Indicates bearing of ADF radio signal.
Synchronizing knob	Is manually rotated to null annunciator and synchronize (electrically and mechanically) compass system.
SET HDG KNOB	Moves the heading select cursor to desired heading.
Heading select cursor	Indicates desired heading.
Power failure indicator (not shown)	Shows to indicate loss of power to compass system.

**5-36. Compass Slaving Switch.** The compass controls with the exception of the COMPASS SLAVING switch, are incorporated in the radio magnetic indicator in this configuration (refer to paragraph 5-35). The compass slaving switch (see figure 2-10) is located in the center area of the pilot's instrument panel. When the switch is in the IN position, the system is operating in the slaved gyro mode. When the switch is in the OUT position the system is operating in the free gyro mode.

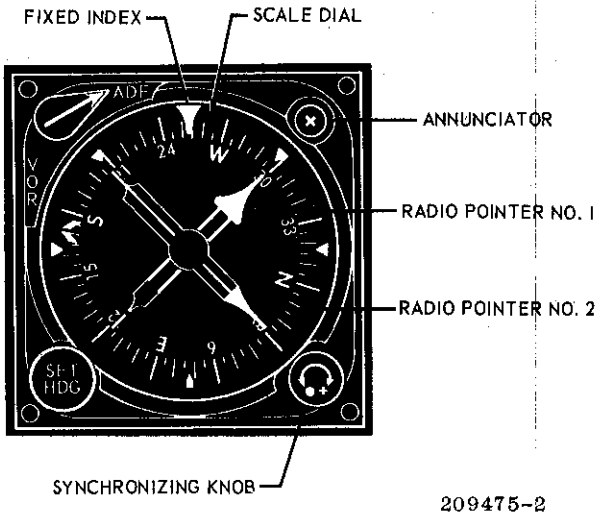

Figure 5-8. Radio magnetic indicator

**5-37. Transponder Control Panel.** This control panel is marked XPDR (transponder) and is installed in the pilot's right console. It provides remote control of the AN/APX-44 Transponder Set. (See figure 5-9.) The controls and indicators on the panel and their functions are as follows:

<u>CONTROL OR INDICATOR</u>	<u>FUNCTION</u>	
Master control	Each position functions as follows:	
	OFF — Removes power from set	
	STBY — Set is in standby condition	
	LOW — Selects low receiver sensitivity	
	NORMAL — Selects normal receiver sensitivity	
Function control	EMER — Transmitter ready for emergency automatic operation	
	Selects operational mode as follows:	
	I/P switch	Enables I/P reply operation as follows:
	MIC	Connects I/P energizing circuits to aircraft microphone key circuits and permits aural I/P for 30 seconds when speaking into the microphone
	OFF — Disconnects microphone keying and I/P initiating circuits	
	I/P — When momentarily actuated initiates I/P operation for 30 seconds	
	Audio switch	ON position permits monitoring transmitted reply pulses
	MODE 2 switch	Provides mode 2 replies for mode 2 interrogations
	MODE 3 switch	Provides mode 3 replies for mode 3 interrogations
	MODE 1 Code control	Selects and indicates the two-digit, mode 1 code number

CONTROL OR INDICATOR

FUNCTION

MODE 3 Code control	Selects and indicates the two-digit, mode 3 code number
Emergency barrier	Prevents accidental placement of master control to the EMER position
Pilot light	Lights when power is applied to the transponder
Lens Shutter	Controls brilliance of pilot light
Test button	Permits test of pilot light

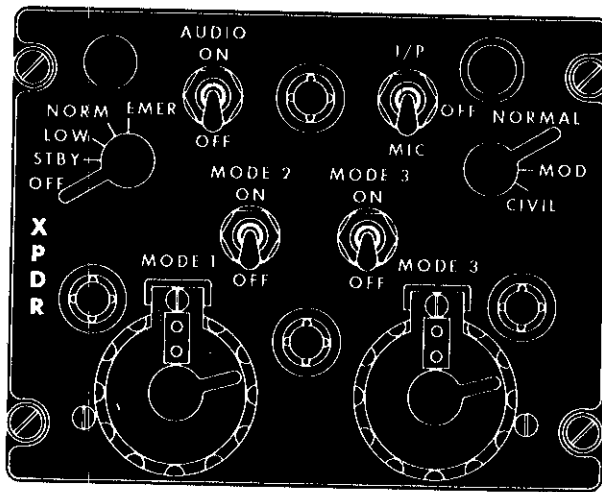

205475-21

Figure 5-9. Transponder control panel

**Section IV — Types of Operating Facilities**

(Not applicable)

**Section V — Preliminary Starting Procedure**

(Not applicable)

**Section VI — Operating Procedures**

**5-38. Interphone Operation.** The procedure for operating the signal distribution panel is presented in the following steps:

- a. Check that helicopter master power switch is on.
- b. Check that ICS circuit breaker is in.
- c. Position transmit interphone selector switch as desired.
- d. Position receiver switches as desired.
- e. Position microphone switch as desired.
- f. Adjust volume control for a comfortable level.

**Note**

No transmission will be made on emergency (distress) frequency channels except for actual emergency purposes in order to prevent transmission of messages that could be construed as actual emergency call messages.

**5-39. UHF Command Set Operation.** The operating procedure for the VHF Command Set is outlined in the following steps:

- a. Check that helicopter master power is on.
- b. Check that UHF XCVR and ICS circuit breakers are in
- c. Set the function selector switch to T/R or T/R plus G as required.
- d. Set the mode selector switch to PRESET CHAN and allow set to warm up.
- e. To monitor the UHF receiver, position RECEIVERS switch No. 2 to forward position.
- f. Rotate PRESET CHAN control to select desired preset frequency.
- g. Position SQ DISABLE switch to OFF.
- h. Adjust VOL control for a comfortable level.
- i. To transmit set the transmit interphone selector switch to position 2.
- j. Position hat switch on cyclic stick to forward position and speak into the microphone.

**5-40. UHF Guard Frequency Operation.** To transmit and receive on the guard frequency, set up the equipment as outlined in paragraph 5-39, steps a., b., and c. Set the mode selector switch to GD XMIT to tune automatically to the guard frequency. Complete steps g., h., i. and j., in paragraph 5-39.

**5-41. Stopping Procedure.** To turn the UHF Command Set off, rotate the function selector switch to OFF position.

**5-42. FM Radio Operation.** The operating procedures for voice transmission and reception,

FM homing and stopping procedure for the FM Radio are presented in the following steps:

- a. Check that helicopter master power is on.
- b. Check that FM XCVR, and ICS circuit breakers are in.
- c. Set the mode selector switch to PTT.
- d. Adjust the frequency control knobs to select the desired operating frequency.

**Note**

A channel changing tone should be heard in the headset while the radio set is tuning. When the tone stops the radio set is tuned.

- e. Set the VOL control on the FM panel to mid position.
- f. Set the SQUELCH control to CARR or as required.
- g. To monitor the FM receiver, set No. 1 of the RECEIVERS switches on the INT panel to forward position.
- h. Adjust VOL on INT panel to a comfortable level.
- i. To transmit set the transmit-interphone selector switch on the INT panel to No. 1 position.
- j. After the set has warmed up, position hat switch on cyclic stick to forward position. (Gunner may use foot switch) and speak into microphone. Note that sidetone is heard in the headset.

**5-43. FM Homing Operation.** The procedure for operating the FM Radio Set in the homing mode is presented in the following steps:

- a. Perform steps a. and b., paragraph 5-46.
- b. Set the mode selector switch to HOME.
- c. Adjust the frequency controls to the frequency of the homing station. The sufficiency of the signal will be indicated by the disappearance of the flags in the course indicator.



d. Set the SQUELCH control to CARR or as required.

e. Fly the course that keeps the vertical pointer of the course indicator in the center of the indicator scale. To insure that the aircraft is not heading away from the station, change the heading slightly and note that the course indicator vertical pointer deflects in the opposite direction to the turn.

f. Over-the-station position is indicated by rapid deflection of the vertical pointer from side to side.

**5-44. Stopping Procedure.** When the equipment is not needed, set the mode control on the FM control panel to OFF.

**5-45. VHF Radio Operation.** The operating procedure for the VHF Radio Set is outlined in the following steps:

a. Check that helicopter master power is on.

b. Check that VHF XCVR and ICS circuit breakers are in.

c. Set the OFF/PWR switch to PWR (power) and allow set to warm up.

d. Rotate the megacycle and kilocycle selector knobs to select the desired frequency.

e. To monitor the VHF receiver position RECEIVERS switch No. 3 to forward position.

f. Adjust VOL control for a comfortable audio level. If signal is not audible with VOL control full clockwise press COMM TEST switch to unsquelch circuits.

g. To transmit, set the transmit interphone selector switch to position 3.

h. Position hat switch on cyclic stick to forward position (gunner may use foot switch) and speak into the microphone.

i. To turn set off, position OFF/PWR switch to OFF.

**5-46. Direction Finder Set Operation.** The ADF control unit mode selector switch enables the selection of three operating modes: ADF mode for automatic direction finding, homing

to a radio station, and position fixing; ANT mode for radio range navigation or use as a radio broadcast station receiver; and LOOP mode for manual direction finding or when using aural null for homing and position fixing. In any operating mode, the direction finder set will provide an aural output of any audio modulating the radio station rf carrier. A beat frequency oscillator (BFO) aids in tuning for zero beat or supplying audio for continuous-wave (cw) signals. To operate the direction finder set in any particular mode, perform the following preliminary steps:

a. Check that helicopter master power is on.

b. Check that ADF RCVR and ICS circuit breakers are in.

c. Set the ADF control unit mode selector switch as desired and allow set to warm up.

**5-47. ADF Operation.** To operate the direction finder set in the ADF mode, perform the preliminary starting procedure in paragraph 5-46 and perform the following steps:

a. Set the mode selector switch to ADF and allow set to warm up.

b. Set the BFO-OFF switch to OFF.

c. Set the band selector switch to the frequency range of a radio range station, an outer marker, or a broadcast station. The range selected will appear in the FREQUENCY window.

d. Rotate TUNE control to the frequency of a radio station and tune for maximum signal level on tuning meter.

e. If audio is desired set NAV switch on INT panel forward to ON and adjust GAIN control on ADF panel for a comfortable sound level. If radio station transmission is continuous wave, set BFO-OFF switch to BFO.

**5-48. Antenna Operation.** When the mode selector switch is set to ANT the direction finder set may be used either for reception of radio broadcast stations or radio range navigation stations. In this mode, the ADF pointers 1 and 2 of radio magnetic indicator are inoperative.

a. Radio Broadcast Reception. Complete the preliminary steps in paragraph 5-46 and perform the following steps:

(1) Set the mode selector switch to ANT.

(2) Set the band selector switch to the frequency range of the desired radio station and tune in radio station for a maximum tuning meter indication.

(3) Set NAV switch on INT panel forward to ON position, and adjust GAIN control on ADF panel for desired sound level.

b. **Radio Range Navigation.** To make a radio range orientation procedure, complete the preliminary steps in paragraph 5-46 and perform the following steps:

(1) Set the mode selector switch to ANT.

(2) Set band selector switch to the frequency range of the radio station.

(3) Set NAV switch on INT panel forward to ON position. While tuning the station in, adjust GAIN control ADF panel for minimum audio output and tune for maximum tuning meter indication. As the range station is approached, the audio output will increase.

(4) Maneuver helicopter to the nearest inbound bisector heading while listening for an increase or decrease in audio level in headset.

(5) Identify the radio beam by making a 180 degree turn to the right after passing through the on-course signal area. If a beam is intercepted before completing the 180 degree turn the helicopter has intercepted the beam forming the left quadrant. Intercepting a beam after completing the turn, means the beam forming the right quadrant has been intercepted.

(6) After identifying the beam, fly on the leg the inbound or outbound heading of which is nearest the desired heading.

**5-49. Manual Loop Operation.** This mode of operation is used for aural null homing and manual direction finding. Aural null homing is useful when ADF bearings are unreliable due to night effect, weather, or another radio station causing hunting or oscillation of the pointer in the radio magnetic indicator. For manual loop operation, perform the preliminary steps in paragraph 5-46, and complete the following:

a. Set the mode selector switch to ANT and band selector switch to the frequency range of radio station to be used.

b. Set the BFO-OFF switch to BFO. Set NAV switch on INT panel forward to on position. Adjust GAIN control on ADF panel for minimum audio output. Tune for zero beat on radio station. Turn BFO-OFF switch OFF.

c. Set mode selector switch to LOOP.

d. Using LOOP switch allow the bearing indicator pointer to rotate to a null. (No sound in headset.) The bearing indicator pointer will stop on this null.

e. In the manual LOOP mode of operation, the null, or indicated bearing may be the true bearing or its reciprocal. Unless the aircraft position is known definitely, this ambiguity must be resolved to determine the bearing from the aircraft to the station.

**5-50. Stopping Procedure.** To turn the direction finder set off, set the mode selector switch to OFF.

**5-51. AN/ASN-43 Gyro Magnetic Compass Starting Procedure.** This compass may be operated magnetically slaved (compass slaving in) or free gyro (compass slaving out). To operate the equipment in either mode, perform the following procedures.

a. Check that helicopter master power is on.

b. Check that GYRO CMPS circuit breakers are in.

c. Check radio magnetic indicator (pilot's only) to ensure power failure indicator is not in view.

**5-52. Slaved Gyro Mode Preflight Operation.** Perform steps a., b., and c. as instructed in paragraph 5-51 and perform the following procedures:

a. Set the COMPASS SLAVING switch to IN.

b. Turn the synchronizing knob, on the radio magnetic indicator, in the direction indicated by the annunciator until the annunciator is centered (nulled).

**Note**

The AN/ASN-43 system does not have a "fast-slewing" feature. If the compass is 180 degrees off the correct aircraft heading when the system is energized it will take approximately 30 minutes for the compass to slave to the correct headings.

c. Check to see that the magnetic heading indicated on the radio magnetic indicator scale dial agrees with a known magnetic heading.

**5-53. Free Gyro Mode Preflight Operation.** Perform steps a., b., and c. as instructed in paragraph 5-51 and perform the following procedures:

a. Set the COMPASS SLAVING switch to OUT.

b. Set the LATITUDE knob (located on the gyro base, in aft fuselage electrical compartment) to the local latitude and set the LATITUDE switch (beside the latitude knob) to N position for northern hemisphere operation or to S position for southern hemisphere operation.

c. Rotate the synchronizing knob on the radio magnetic indicator to set the scale dial to a known heading reference.

d. Check to see that the annunciator moves to the center position and then does not change (annunciator is de-energized in the free gyro mode).

**5-54. Inflight Operation.** For inflight operation of the gyro magnetic compass system perform the following steps:

a. Set the COMPASS SLAVING switch to IN or OUT as desired for magnetically slaved or free gyro mode of operation. Free gyro mode is recommended when flying in latitudes higher than 70 degrees.

b. When operated in the slaved mode, the system will remain synchronized during normal flight maneuvers. During violent maneuvers the system may become unsynchronized, as indicated by the annunciator moving off center. The system will slowly remove all errors in synchronization; however, if fast synchronization

is desired turn the synchronizing knob in the direction indicated by the annunciator until the annunciator is centered again.

c. When operating in the free gyro mode, periodically update the heading to a known reference by rotating the synchronizing knob.

d. The compass system is turned off when helicopter electrical power is turned off.

**5-55. Transponder Set Operation.** The preliminary starting procedure and different modes of operation for the AN/APX-44 Transponder Set are given in the following paragraphs:

a. Preliminary Starting Procedure. Set the controls on the control panel as follows:

- (1) Master control — OFF.
- (2) AUDIO switch — OFF.
- (3) I/P switch — OFF.
- (4) MODE 2 switch — OFF.
- (5) MODE 3 switch — OFF.
- (6) MODE 1 control — To read 00.
- (7) MODE 3 control — To read 00.
- (8) Function control — NORMAL.

b. Starting Procedure.

- (1) Check that master helicopter power is on.
- (2) Check that IFF XPDR circuit breaker is in.
- (3) Place the master control in STBY position. The pilot light should light.
- (4) If the pilot light does not light, press the test button. If the light does not light when the test button is pressed, either light is burned out or operating power is not reaching the transponder set.
- (5) Adjust the pilot light to the desired brilliance by opening or closing the lens shutter.
- (6) Allow transponder set to warm up.

**5-56. Normal Operation.** The normal operating procedure is outlined in the following steps:

a. For Mode 1 operation, set the controls as follows:

- (1) Function control — NORMAL.
- (2) Master control — LOW or NORM as required.
- (3) MODE 2 switch — OFF.
- (4) MODE 3 switch — OFF.
- (5) I/P switch — Refer to paragraph 5-59.
- (6) AUDIO switch — Refer to paragraph 5-60.

b. Combined modes 1 and 2. Set the controls as follows:

- (1) Function control — NORMAL.
- (2) Master control — LOW or NORM as required.
- (3) MODE 2 switch — ON.
- (4) MODE 3 switch — OFF.
- (5) I/P switch — Refer to paragraph 5-59.
- (6) AUDIO switch — Refer to paragraph 5-60.

c. Combined modes 1 and 3. Set the controls as follows:

- (1) Function control — NORMAL.
- (2) Master control — LOW or NORM as required.
- (3) MODE 3 switch — ON.
- (4) MODE 2 switch — OFF.
- (5) I/P switch — Refer to paragraph 5-59.
- (6) AUDIO switch — Refer to paragraph 5-60.

d. Combined modes 1, 2 and 3. Set the controls as follows:

- (1) Function control — NORMAL.
- (2) MODE 2 switch — ON.
- (3) MODE 3 switch — ON.
- (4) Master control — LOW or NORM as required.
- (5) I/P switch — Refer to paragraph 5-59.
- (6) AUDIO switch — Refer to paragraph 5-60.

**5-57. Modified Operation.** The procedure for operating with the function selector at MOD position is outlined in the following steps:

a. MODE 1. Set the controls as follows:

- (1) Function control — MOD.
- (2) MODE 1 code control — Assigned two digit code number.
- (3) Master control — LOW or NORM as required.
- (4) MODE 2 switch — OFF.
- (5) MODE 3 switch — OFF.
- (6) I/P switch — Refer to paragraph 5-59.
- (7) AUDIO switch — Refer to paragraph 5-60.

b. Combined Modes 1 and 2. Set the controls as follows:

- (1) Function control — MOD.
- (2) MODE 1 code control — Assigned two digit code number.
- (3) MODE 2 switch — ON.
- (4) Master control — LOW or NORM as required.
- (5) MODE 3 switch — OFF.
- (6) I/P switch — Refer to paragraph 5-59.
- (7) AUDIO switch — Refer to paragraph 5-60.

c. Combined Modes 1 and 3. Set the controls as follows:

- (1) Function control — MOD.
- (2) MODE 2 switch — OFF.
- (3) MODE 3 switch — ON.
- (4) MODE 1 code control — Assigned two digit code number.
- (5) MODE 3 code control — Assigned two digit code number.
- (6) Master control — LOW or NORM as required.
- (7) I/P switch — Refer to paragraph 5-59.
- (8) AUDIO switch — Refer to paragraph 5-60.

d. Combined modes 1, 2 and 3. Set the controls as follows:

- (1) Function control — MOD.
- (2) Mode 1 code control — Assigned two digit code number.
- (3) MODE 2 switch — ON.
- (4) MODE 3 switch — ON.
- (5) MODE 3 code control — Assigned two digit code number.
- (6) Master control — LOW or NORM as required.
- (7) I/P switch — Refer to paragraph 5-59.
- (8) AUDIO switch — Refer to paragraph 5-60.

**5-58. Civil Operation.** The procedure for operating with the function selector at civil position is outlined in the following steps:

a. Combined Civil and Military Mode 1. Set the controls as follows:

- (1) Function control — CIVIL.
- (2) MODE 3 code control — Assigned two digit code number.

(3) MODE 3 switch — ON.

(4) MODE 2 switch — OFF.

(5) MODE 1 code control — Assigned two digit code number.

(6) Master control — LOW or NORM as required.

(7) I/P switch — Refer to paragraph 5-59.

(8) AUDIO switch — Refer to paragraph 5-60.

b. Combined Civil and Military Mode 1 and 2. Set the controls as follows:

- (1) Function control — CIVIL.
- (2) MODE 3 code control — Assigned two digit code number.
- (3) MODE 3 switch — ON.
- (4) MODE 2 switch — ON.
- (5) MODE 1 code control — Assigned two digit number.
- (6) Master control — LOW or NORM as required.
- (7) I/P switch — Refer to paragraph 5-59.
- (8) AUDIO switch — Refer to paragraph 5-60.

**5-59. I/P (Position Identification) Operation.** The pilot may identify the position of his helicopter without being interrogated by a ground based IFF system. This type of operation is initiated by the pilot upon receipt of request via communications set, or upon arrival at the pre-established check points. The transponder set will transmit position identifying signals when either of the following procedures are used:

a. Procedure No. 1. To transmit position-identifying signals, momentarily hold the I/P switch in the I/P position.

b. Procedure No. 2, perform the following steps.

- (1) Place the I/P switch in MIC position.

(2) Momentarily press the switch on the microphone; the transponder set is now transmitting position identifying signals.

(3) Place the I/P switch in the OFF position.

**Note**

The I/P switch may remain in the MIC position for the duration of a flight. This permits position-identifying signals to be transmitted each time the radio-telephone equipment is operated.

**5-60. Monitoring.** Monitor the reply pulses transmitted by the transponder set as follows:

a. Place the AUDIO switch in the ON position. Transmitted reply pulses, following interrogation, will be audible in the pilot's headset.

b. Immediately following completion of the monitoring procedure, place the AUDIO switch in the OFF position.

**5-61. Emergency Operation.** In the event of an emergency or distress condition, the transponder set may be used to transmit specially coded emergency signals. These emergency signals are automatically set up and will be transmitted as long as the master control of the transponder set remains in the EMER position. Even after the transponder set is interrogated by a ground-based IFF system, these signals will continue to be transmitted automatically, regardless of any mode and function combination previously set up, and will provide indications

to the ground-based IFF system that the helicopter is in an emergency or distress condition. For emergency operation, set the controls as follows:

a. Depress and hold the emergency barrier button.

b. Turn the master control to the EMER position.

c. Release the barrier button.

d. Permit the master control to remain in the EMER position for the duration of the emergency.

e. When the emergency is over, return the master control to the NORM or LOW position.

**5-62. Stopping Procedure.** To turn off the transponder set, set the controls on the control panel as follows:

a. Master control — OFF.

b. AUDIO switch — OFF.

c. I/P switch — OFF.

d. MODE 2 switch — OFF.

e. MODE 3 switch — OFF.

f. MODE 1 code control — To read 00.

g. MODE 3 code control — To read 00.

h. Function control — NORMAL.

**Section VII — Inspection**

(Not applicable)

**Section VIII — Operation Of Electronic Equipment  
In Conjunction With Other Items**

(Not applicable)

## CHAPTER 6

### AUXILIARY EQUIPMENT

#### Section I — Scope

**6-1. Scope.** This Chapter includes the description, normal operation and emergency operation of all equipment not directly contributing to flight, but which enables the helicopter to perform certain specialized functions.

**6-2.** Much of the equipment discussed in this Chapter is highly specialized or interchangeably used in many aircraft. Coverage for specialized or interchangeable equipment of this type will be brief, since complete coverage is available in publications devoted entirely to that equipment.

#### Section II — Heating and Ventilation

**6-3. Ventilating System.** The ventilating air is supplied by an air inlet located on the leading edge of the pylon fairing. The outside air is routed to the transmission mounted blower for boosting. The transmission mounted blower has no controls and is supplying air any time the transmission gear system is turning. The pilot has adjustable outlets on his instrument panel and deck type outlets on each side of the instrument panel shroud. The outlets located on the instrument panel shroud are to provide defrosting air for the canopy area. The ventilating air is also routed to and through the pilot's seat and back cushion. The gunner has two instrument panel mounted ventilating diffusers. The ventilating air is also routed to and through the gunner's seat and back cushions. The amount of air that is supplied through the ventilators, is regulated by the internal butterfly in the diffuser. The air is exhausted out of the cockpit area into the compartment just aft of the pilot. The air is then used to cool components located in this area.

**6-4. Ventilating System Control.** The main ventilating system control is located in the lower right area of the pilot's instrument panel (see figure 6-1). The control handle is round with a spring loaded center push-to-release button. When the control is full IN the ventilating system is off and when the control is pulled full

OUT the maximum system air volume is provided. The pilot is provided a control valve, located at the top left corner of his seat back, to control the volume of air for cushion ventilation.

**6-5. Operation.** Rotate diffusers to desired output and position internal valve for desired quantity. Actuate instrument panel mounted heat-vent control handle to desired position. With control full out maximum air is utilized.

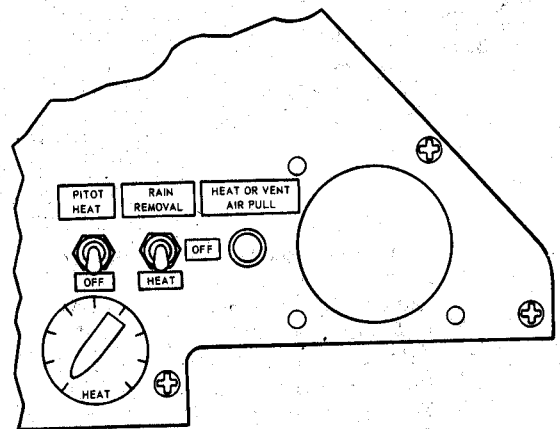

209070-9

Figure 6-1. Heater controls

**6-6. Heating System.** The helicopter's heating system (see figure 6-2) consists of tube assemblies, temperature selector, noise suppressors, ducts, outlets, and control panel. Heat is supplied from the engine compressor bleed

air. Engine bleed air is mixed with ambient air through a temperature sensing device and mixing valve to provide thermostatic control of cockpit temperature. Electric power for the system is furnished from the non-essential bus.

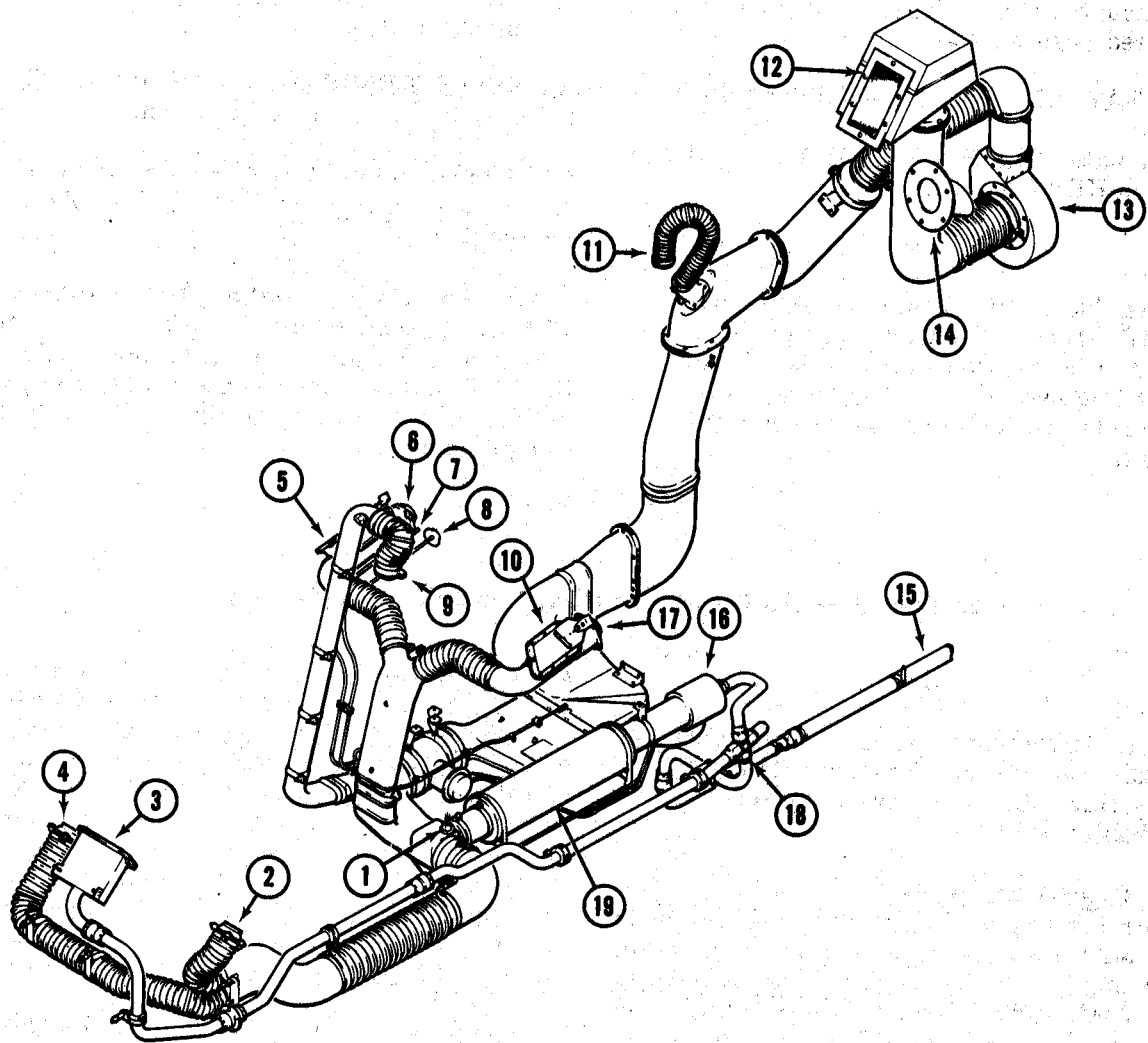

- |                                  |                                    |
|----------------------------------|------------------------------------|
| 1. Thermal Switch                | 11. Pilot's Cushion Air Supply     |
| 2. Gunner Compartment Air Outlet | 12. Air Inlet                      |
| 3. Rain Removal Outlet           | 13. Transmission Mounted Blower    |
| 4. Gunner Compartment Air Outlet | 14. Compartment Exhaust Outlet     |
| 5. Defroster Outlet              | 15. Bleed Air Supply From Engine   |
| 6. Pilot Compartment Air Outlet  | 16. Mixing Valve                   |
| 7. Heat and Vent Manual Control  | 17. Pilot's Compartment Air Outlet |
| 8. Temperature Selector          | 18. Heat-Rain Removal Valve        |
| 9. Gunner's Cushion Air Supply   | 19. Noise Suppressor               |
| 10. Defroster Outlet             |                                    |

209070-15

Figure 6-2. Heating and ventilation system



**6-7. Crew Compartment Heater Controls.** The heater controls are located in the lower right corner of the pilot's instrument panel. There are three controls: Heat-Rain Removal switch, Temperature switch and Heat-Vent Control.

**6-8. Heating System Operation.** a. Set instrument panel mounted HEAT (rheostat switch) control to desired position (see figure 6-1).

b. HEAT-VENT control — Full OUT.

c. Actuate RAIN REMOVAL — HEAT switch to HEAT position.

**Note**

The bleed air heater (RAIN REMOVAL-HEAT switch) should be in the OFF position during take-off and landing and other flight conditions requiring maximum engine power available.

d. Adjust diffuser outlets to desired volume and position.

**Note**

Reset instrument panel HEAT rheostat control as temperature requirements change.

e. RAIN REMOVAL — HEAT switch — OFF to deactivate heating system.

**6-9. Heating System Emergency Operation.** There is no emergency operation of the bleed air heating system.

**6-10. Defrosting — Defogging — Anti-icing of Crew Compartment.** Defrosting, defogging and anti-icing is operative continually and the pilot has no control except that the panel outlets may be closed to direct all air to the canopy area.

### Section III — Anti-icing, De-icing And Defrosting Systems

**Note**

The defrosting system is combined with the heating system. Refer to Heating and Ventilation Systems — Chapter 6, Section II.

**6-11. Engine Anti-icing.** The anti-icing system for the engine functions to prevent icing of the air inlet areas when engine is operating at freezing temperatures. The system consists of an electrically operated hot-air valve. The system is electrically operated and powered by the 28 volt dc essential bus.

**6-12. Principles of Anti-icing Operation.** The ENGINE AIR caution light is illuminated when its pressure switch senses a negative pressure in the engine induction system. The illumination of this caution light notifies the pilot and gunner that the engine induction system screen is restricting the flow of engine air. This condition may result from foreign material or ice accumulation on the screen. The bypass should be opened when the ENGINE AIR caution light is illuminated and if ice accumulation is suspected the ENGINE AIR switch should be

actuated from the FILTER position forward to the FILTER BYPASS or DE-ICE position as required by climatic conditions. Refer to Chapter 7, Section II for limitations on opening of bypass door. With the ENGINE AIR switch in the FILTER BYPASS position, filter bypass door circuit is energized and bypass door will open. With ENGINE AIR switch in DE-ICE position the bypass door circuit is energized and the hot air valve circuit is de-energized allowing hot air to be extracted from the annular manifold within the diffuser housing. This hot air is then directed through five of the six hollow inlet housing support struts to de-ice the air inlet area. Hot scavenge oil draining the lower strut into the accessory drive gear box, de-ices the bottom of the air inlet area. Hot air is also directed into the inlet guide vane area and through an annulus around the region of the temperature sensing element of the main fuel control to prevent ice formation in the area of the ambient temperature sensing bulb. Small openings in the bottom of the inlet guide vanes allow hot air to bleed back into the compressor area. The valve of the air flow shut-off regulator is "fail safe" loaded in the OPEN or ON position but must

be manually operated by the ENGINE AIR switch, when electrical power is available to the system. In the event of electrical failure, anti-icing becomes continuous.

**6-13. Pitot Heater.** The pitot heater is installed on the pitot head and functions to prevent ice forming in the pitot tube. Electric power for the pitot heater operation is supplied from the 28 volt non-essential bus. Circuit protection is provided by a circuit breaker, marked PITOT TUBE HTR.

**6-14. Pitot Heater Switch.** The pitot heater switch is located on the instrument panel (see figure 6-1). The switch is two-position with up position ON and down position OFF.

**6-15. Operation Pitot Heater System.** The pitot heater switch should be in the up position to prevent ice forming in pitot tube. To shut off pitot heater, position switch to OFF position (down).

**6-16. Rain Removal.** Rain removal is accomplished by the bleed air heater system. The

bleed air is directed at the base of the windshield and removes the rain. The electrical power for the operation of the rain removal system is provided by the 28 volt dc non-essential bus.

**6-17. Rain Removal Operation.** The rain removal system is controlled by the RAIN REMOVAL-HEAT switch. Place switch in RAIN REMOVAL position and bleed air is directed to base of windshield.

**Note**

When RAIN REMOVAL is being utilized the cabin heat system will be non-functional.

The bleed air heater (RAIN REMOVAL-HEAT switch) should be in the OFF position during take-off and landing and other flight conditions requiring maximum engine power available.

**Section IV — Lighting Equipment**

**6-18. Position Lights.** The position lights consist of three lights. A green light is located in the right wing tip, a red light is located in the left wing tip and a white light is located on the upper section of the ventral fin. Electrical power is supplied from the 28 volt dc system. Circuit protection is provided by the POSITION lights circuit breaker.

**6-19.** The position lights are controlled from the LIGHTS control panel (see figure 6-3). Two switches are provided for the control of the position lights FLASH-STEADY and BRT-DIM. The Flash-steady switch is a three position switch with the circuit de-energized when the switch is in the center position (OFF). The BRT-DIM switch is a two position switch and when in the forward position the bright circuit of the position lights is energized. The aft position energizes the dim circuit.

**6-20. Anti-Collision Light.** The anti-collision light is mounted on top of the pylon fairing.

Electrical power for the anti-collision light circuit is provided by the 28 volt dc non-essential bus.

**6-21.** The anti-collision light switch is located in the LIGHTS control panel (see figure 6-3). The switch is a two-position toggle switch marked ANTI-COLL LT and OFF. The forward position energizes the anti-collision light circuit.

**Caution**

Under instrument conditions, particularly at night, through conditions of reduced visibility, unnecessary operation of the anti-collision light should be avoided. Uncommon reflections on the helicopter's windows caused by rotating light being reflected back from the clouds through the whirling blades may cause vertigo.

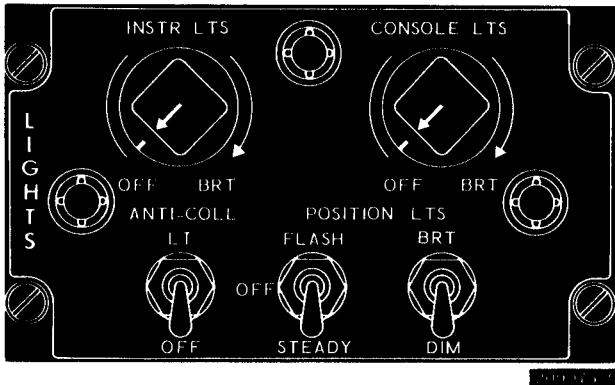

Figure 6-3. Lights control panel

**6-22. Landing Lights.** Two controlled landing lights are located inside the transparent nose section. The lights are controlled by a single actuator that provides travel for the lights for 10 degrees up and 20 degrees down from the helicopter's horizontal center line. Electrical power for the landing lights is supplied by the 28 volt dc essential bus. The electrical control of the light is supplied by the 28 volt dc non-essential bus. The landing light switch is located on the control head of the pilot's collective stick.

**6-23. Search Light.** The controllable search light is provided in the lower section of the fuselage just aft of the ammunition compartment. Electrical power for the search light is supplied by the 28 volt dc essential bus. The electrical control of the light is supplied by the 28 volt dc non-essential bus. The search light switch is located on the collective stick control head.

**6-24. Crew Compartment Lights.** The pilot's cockpit light is located overhead on the canopy frame. The gunner's cockpit light is located above and aft of the gunner. Rheostat operating switches for each light are mounted on the light assembly body. Brightness is controlled by operation of the rheostat. The rheostat is also the ON-OFF switch for the light assembly. Electrical power for the light circuit is supplied from the 28 volt dc non-essential bus.

**6-25. Pilot's Instrument Lights Control Panel.** The pilot's instrument lights control (figure 6-3) is located in the pilot's right console. This panel contains two switch type rheostats for activating and dimming various instrument lights. The switch type rheostats are marked INSTRUMENT LTS and CONSOLE LTS. Electrical power for the instrument lights is supplied by the 28 volt dc non-essential bus.

**6-26. Pilot's Instrument Lights.** The pilot's instruments are all provided with a hooded type light. These lights are all on one circuit and are controlled by the switch type rheostat labeled INSTRUMENT LTS. Clockwise rotation of rheostat knob turns on the lights and increases brilliance. Counterclockwise rotation of the knob dims lights and the final motion (OFF) deactivates the electrical circuit to the instrument lights.

**6-27. Pilot's Console Panel Lights.** The console panel lights furnish the illumination for both the right and left side console panels. Each panel is individually illuminated and brilliance control is accomplished by means of a rotary type rheostat located in the right console. Clockwise rotation of the rheostat knob activates the console panels circuits and increases the brilliance. Counterclockwise rotation of the knob dims, with final movement (OFF) deactivating the electrical circuit.

**6-28. Gunner's Instrument And Panel Lights.** The gunner's instrument and panel lights are controlled by the switch type rheostat located in the miscellaneous control panel (Chapter 2, figure 2-20) in the gunner's left console. The gunner's lights are activated and brilliance controlled by means of a switch type rheostat. Clockwise rotation of the rheostat knob activates all gunner instrument and control panel lights and increases brilliance. Counterclockwise rotation of the knob dims with final movement deactivating the circuit. Electrical power for the gunner's instrument and panel lights circuit is supplied from the 28 volt dc non-essential bus.

## Section V — Oxygen System

(Not Applicable)

## Section VI — Auxiliary Power Unit

(Not Applicable)

## Section VII — Armament Systems

**6-29. TAT-102A Armament Subsystem.** The TAT-102A Armament Subsystem is a single gun, hydraulically and electrically operated system providing wide angular coverage and rapid fire. The system is gunner controlled as a fully flexible system, and pilot controlled as a forward firing system with gun stowed. The system consists essentially of five main subassemblies: turret, gunner's sighting station, gunner's

control panel, electronic control subassembly and ammunition feed system (see figure 6-4).

**6-30.** The hydraulically driven turret is housed inside an aerodynamically designed fairing located forward and below the gunner station. The turret mounts a 7.62 mm automatic gun which is capable of short bursts or prolonged firing at rates of 1300 or 4000 rounds per minute. The turret can position the automatic gun

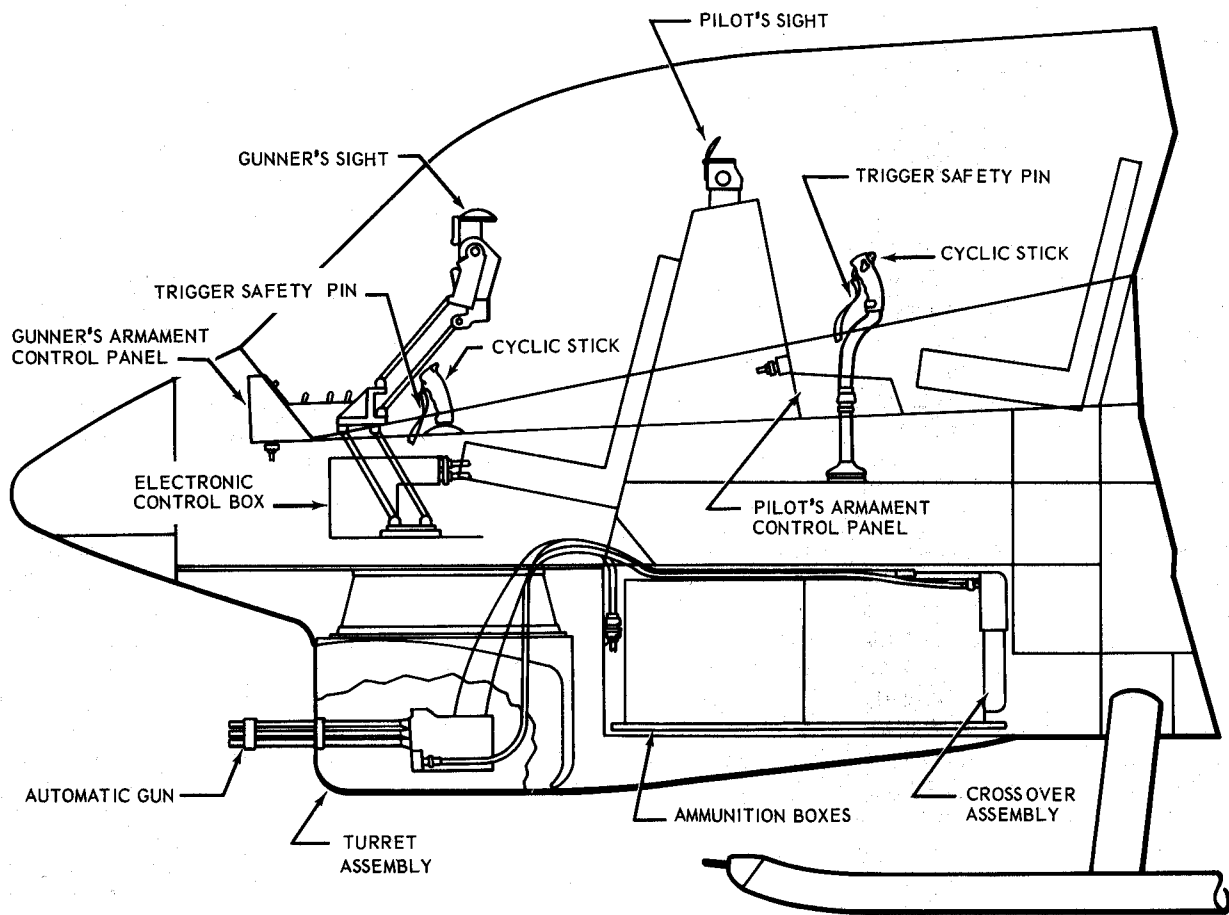

209071-3A

Figure 6-4. TAT-102A armament subsystem

(GAU-2B/A) 115 degrees left and right of the forward position. Gun elevation is variable from 15 to 25 degrees, depending on the azimuth position of the turret. Gun depression is 50 degrees at all azimuth positions.

**6-31.** The sighting station consists essentially of a simple compensating sight head and hand grip assembly attached to the aircraft floor. The sighting station, mounted in the gunner station forward of the gunner, allows the gunner to train and fire the gun. Air data sensor input and estimated range data are fed to azimuth and elevation resolver and amplifier circuits within the sighting station to provide gross correction due to aircraft speed.

**6-32.** The gunner's control panel contains the controls and indicators required by the gunner to operate and monitor the system. The control panel is located in the gunner station in the right deck forward of the flight controls.

**6-33.** The electronic control subassembly contains the azimuth and elevation amplifiers, power supplies, dither and coincidence circuits, and control circuits required to operate the system. The electronic control subassembly is located below the gunner's control panel. Electrical power for the armament system is supplied by the 28 volt dc non-essential bus.

**6-34.** The ammunition feed system consists basically of ammunition storage boxes, a crossover assembly, a flexible ammunition feed chute, and a synchronized cartridge drive assembly. The ammunition stowage boxes are mounted in the aircraft aft of the turret. The flexible feed chute guides the ammunition from the stowage boxes to the gun feeder. The cartridge drive assembly is connected by a flexible shaft to the gun drive. The flexible shaft synchronizes the transportation of cartridges to the gun.

**6-35.** The pilot's control panel is not a part of the TAT-102A Armament Subsystem; however, the gun may be fired in the stowed position from the pilot station.

**6-36. Gunner's Control Panel.** The gunner's control panel (figure 6-5) contains the controls and indicators necessary to operate and monitor the armament system. Emergency provisions on the control panel are available for the gunner to take command and fire the system in case the pilot is disabled.

a. Controls. Following is a list of gunner's control panel controls and their functions:

(1) TURRET POWER Switch. The TURRET POWER switch, when placed in the fwd position, energizes the azimuth and elevation stow lock release solenoids which mechanically unstow the turret. The switch also energizes the turret power relay to provide plus 28 volt dc and minus 28 volt dc to the system and applies 28 volt dc to the contacts of the action and compensation switches in the sighting station. The turret power indicator illuminates (green) when the TURRET POWER switch is placed in the forward position.

(2) TURRET MODE Switch. The TURRET MODE switch, when placed in the AREA position, energizes a circuit which causes the gun to oscillate 60 mils in azimuth about its trained position. Placing the switch in the POINT position de-energizes the circuit and allows the gun to remain stable in its trained position.

(3) AMMO FIREOUT Switch — The last round switch in the ammunition box crossover chute opens when the last round of ammunition passes over the switch, thereby interrupting the electrical signal to the gun drive control valve. The rounds remaining in the crossover and flexible chute facilitate the reloading of ammunition. In an emergency, the ammunition remaining in the crossover and flexible chute may be fired by placing the AMMO FIREOUT switch to the fwd position. This permits the electrical signal to bypass the last round switch and allows the remaining rounds to be fired.

(4) WP UNCLR — WPN CLEAR switch.

(a) With the WPN UNCLR — WPN CLEAR switch in the WPN-CLEAR position at the end of firing cycle, a delayed dropout relay prolongs the electrical signal to the gun drive control valve for a period of time sufficient to rotate the gun through at least one full revolution. The gate on the feeder closes as soon as the trigger is released. The closed gate prevents the cartridges from chambering in the gun and since the gun rotates at least one full revolution with gate closed, this assures that gun is clear of live rounds.

(b) With the WPN UNCLR — WPN CLEAR switch in the WPN-UNCLR position the delayed dropout relay is bypassed and the weapon stops almost instantaneously with release of triggers. The gun may have live rounds in it. This mode is incorporated only to conserve ammunition and should be used only in combat. When switch is in WPN UNCLR position, the indicator illuminates (amber).

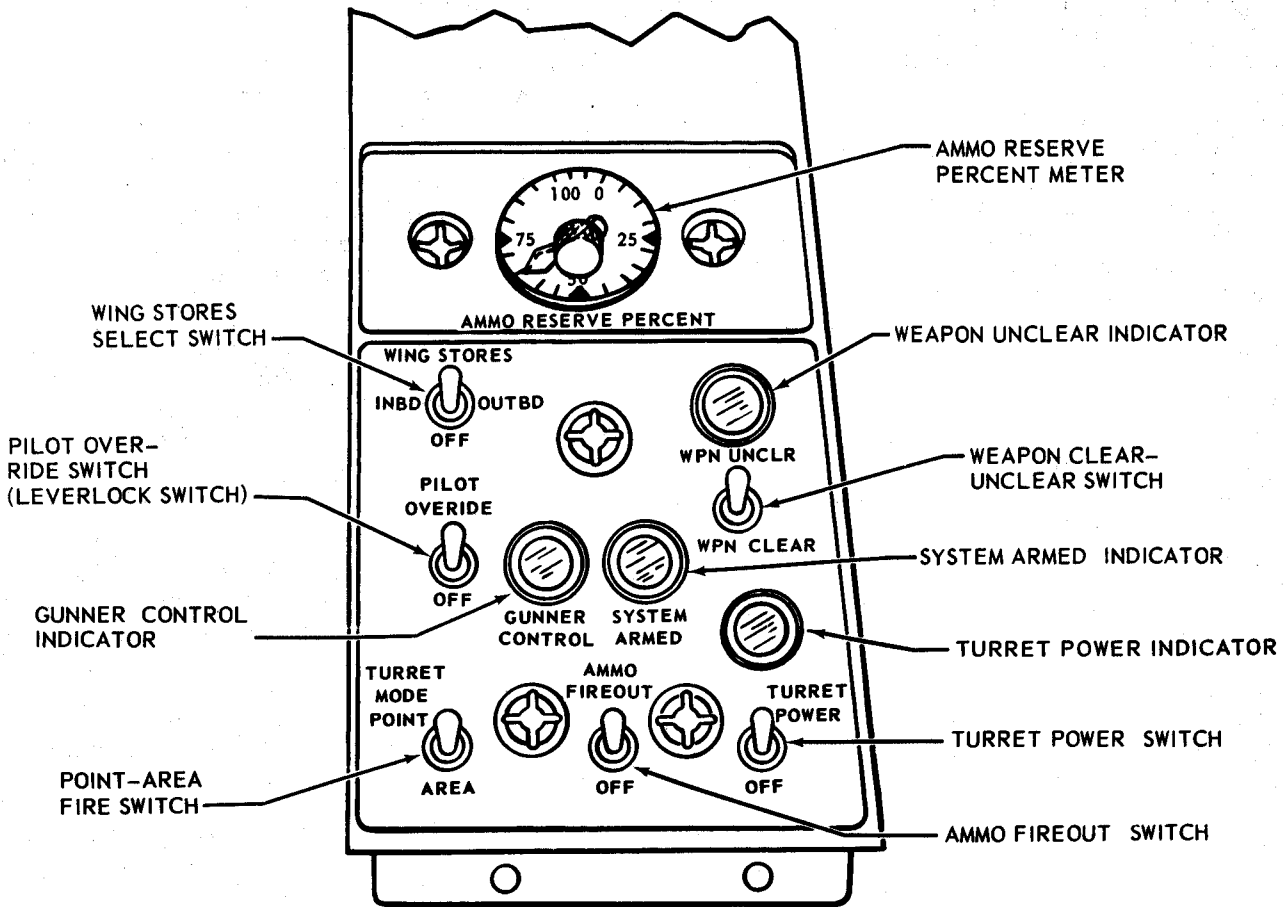

2 09071-5B

Figure 6-5. Gunner's armament control panel

(5) **PILOT OVERRIDE Switch.** The **PILOT OVERRIDE** switch is an emergency switch which permits the gunner to take command of the armament system when the pilot is incapacitated. Placing the switch in the fwd position energizes the pilot override relay and transfers control of the armament system and the wing pods to the gunner. In this condition, the system is fired using the triggers on the gunner's cyclic control. The system **ARMED** indicator illuminates (amber) and the **GUNNER CONTROL** indicator illuminates blue when the switch is placed in the **PILOT OVERRIDE** (fwd) position.

(6) **WING STORES Switch.** If the **PILOT OVERRIDE** switch is in the fwd position, the **WING STORES** switch may be used to select

either inboard or outboard wing pods for firing. Pod stores are fired by using the thumb button on the gunner's cyclic control.

b. **Indicators.** Following is a list of gunner's control panel indicators and their functions.

**Note**

The incandescent lamps in the indicators on the gunner's control panel may be tested by pressing the indicator lens. The lamp intensity may be varied by rotating the indicator lens.

(1) **SYSTEM ARMED Indicator.** The **SYSTEM ARMED** indicator illuminates (amber) when the pilot's **MASTER ARMED** switch is

placed in the ON position or when the gunner's PILOT OVERRIDE switch is placed in the fwd position, indicating that the turret control system is energized.

(2) TURRET POWER Indicator. The TURRET POWER indicator illuminates (green) when the TURRET POWER switch is placed in the fwd position.

(3) GUNNER CONTROL Indicator. The GUNNER CONT indicator illuminates when the CONTROL SELECTOR switch on the pilot's control panel is in the GUNNER position, indicating that the gunner has control of the system. Also the indicator illuminates when the PILOT OVERRIDE switch is placed in the fwd position.

(4) WEAPON UNCLEAR Indicator. The WEAPON UNCLEAR indicator illuminates (amber) when the WPN UNCLEAR-WPN CLEAR switch is in the WPN UNCLR position.

(5) AMMO RESERVE PERCENT Meter. The AMMO RESERVE PERCENT meter receives electrical impulses from the rounds counter switch in the ammunition storage box crossover chute and indicates the percent of ammunition remaining in the ammunition box.

**6-37. Sighting Station.** The sighting station (figure 6-6) provides the means for the gunner to train and fire the turret gun. The sighting station is located in the gunner station and is mounted on the floor of the aircraft forward of the gunner. The sighting station may be positively stowed in an out-of-the-way position when not in use.

**6-38.** The purpose of the sighting station is to provide a line of sight for accurate firing of the gun. Training the gun is accomplished by a sighting head which projects a collimated reticle image to provide the gunner with a line of sight. Air speed and estimated range data may be fed to resolver and amplifier circuits within the sighting station to provide gun line correction.

**6-39.** The sighting station consists of a simple compensating sight head mounted in a gimbal assembly which pivots on the support structure. Two hand grips, which allow the gunner to position the turret and fire the gun, are attached to the elevation gimbal. Movement of

the sight head generates electrical signals which are fed through the sighting station to the turret assembly positioning circuits.

a. Positioning the turret. Azimuth and elevation movement of the turret is accomplished by using either, or both, of the sighting station hand grips. Depressing the action switch on the hand grip and rotating the sight horizontally will rotate the turret about its azimuth axis; rotating the sight vertically will rotate the gun about its elevation axis. When the hand grips are released, the action switches open and the turret slews to its stowed position.

b. Firing the gun. Firing the gun is accomplished by using either, or both, of the hand grips. Depressing the action switch and the low rate firing trigger on top forward side of the grip will fire the gun at a rate of 1300 rounds per minute; then depressing the high rate firing button on the aft side of the grip will fire the gun at a rate of 4000 rounds per minute. The gun cannot be fired at the high rate unless the low rate trigger is first depressed.

**Note**

Both firing rates have a plus or minus 400 rounds.

c. Turret coincidence. If the action switch is depressed and the sight rotated at a speed greater than the turret maximum angular velocity, the firing circuit is interrupted and the sight reticle blinks until the gun line is coincident within eight degrees to the line of sight.

d. Controls. Following is a list of sighting station controls and their functions.

(1) Action Switches. The action switches are located on the lower forward side of the hand grips. Depressing either, or both, of the action switches applies voltage to the trigger switches and energizes circuits which put the turret assembly under the control of the sighting station. Releasing the action switch(es) allows the turret assembly to return to stow position.

(2) Low Rate Firing Triggers. The low rate firing triggers are located on top forward side of the hand grips. Depressing the action switch and either, or both, low rate firing

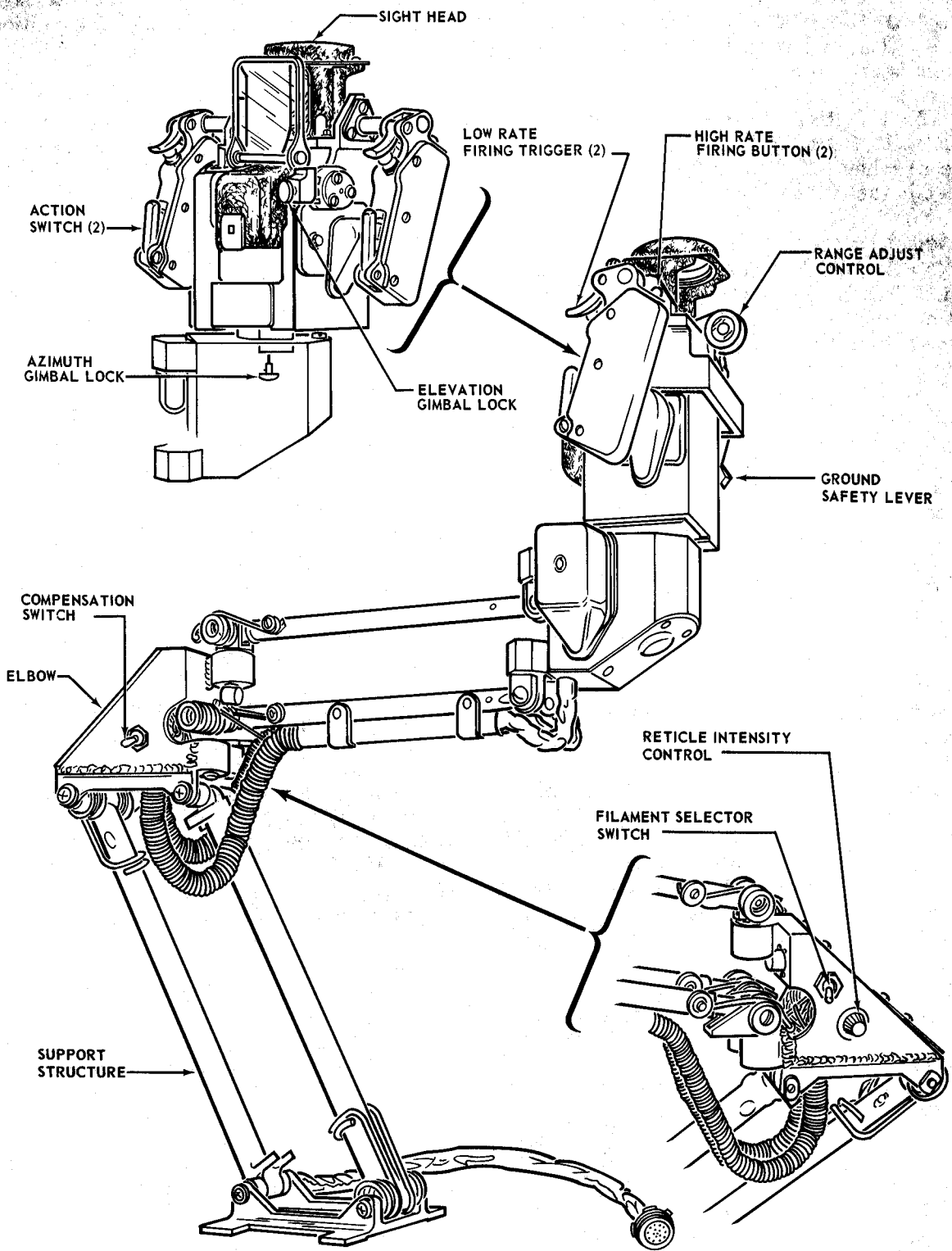

209071-6B

Figure 6-6. Gunner's sighting station



triggers energizes control circuits which cause the gun drive motor to drive the gun at the 1300 rounds per minute rate.

(3) **High Rate Firing Button.** The high rate buttons are located on the upper aft side of the hand grips. To fire the gun at a high rate, the action switch and the low rate firing trigger must be depressed first. Then depressing either, or both, high rate button switches energizes control circuits which cause the gun drive motor to drive the weapon at the 4000 rounds per minute rate.

(4) **COMPensation Switch.** The compensation switch is located on the left side of the support structure elbow. When the compensation switch is placed in the IN position, the compensation relay is energized and airspeed data and estimated range data are fed to the turret positioning circuits to provide gun line correction. When the compensation switch is in the OUT position, gun line correction is achieved manually by adjusting the impact area.

(5) **FILament Selector Switch.** The filament selector switch is located on the right side of the support structure elbow. The filament selector switch is used to select either filament of the dual-filament reticle incandescent lamp.

(6) **Reticle Intensity Control.** The reticle intensity control is a variable resistor which is mounted on the right side of the support structure elbow. The control adjusts the intensity of the sight reticle.

(7) **Range Adjust Control.** The range adjust control is a variable resistor, mounted above the right hand grip. The range adjust control knob is calibrated in meters. When the compensation switch is in the IN position, the control allows the gunner to supply an estimated range input to the turret positioning circuits for gun line range correction.

(8) **Ground Safety Lever.** The ground safety lever is a mechanical device, located on the left side of the azimuth gimbal. The lever, when positioned down, mechanically prevents the sight elevation gimbal from being depressed

more than 20 degrees below horizontal. This assures that the gun will not be driven into the ground during ground testing of the aircraft. During flight, the lever should be positioned up to allow full depression of the gun.

(9) **Azimuth and Elevation Gimbal Locks.** The azimuth and elevation gimbal locks mechanically lock the sight gimbals.

**6-40. Turret.** The turret (figure 6-7) is located in an aerodynamically designed fairing forward and below the gunner station. It contains the 7.62 mm automatic gun, azimuth and elevation gimbals, a flexible ammunition chute, and the necessary hydraulic and electrical components for operating the turret and firing the gun.

**6-41.** The turret responds to electrical signals generated in the sighting station. When the subsystem is energized, and the gunner does not control the turret assembly through the sighting station, the turret assembly remains at zero elevation and zero azimuth (stow position).

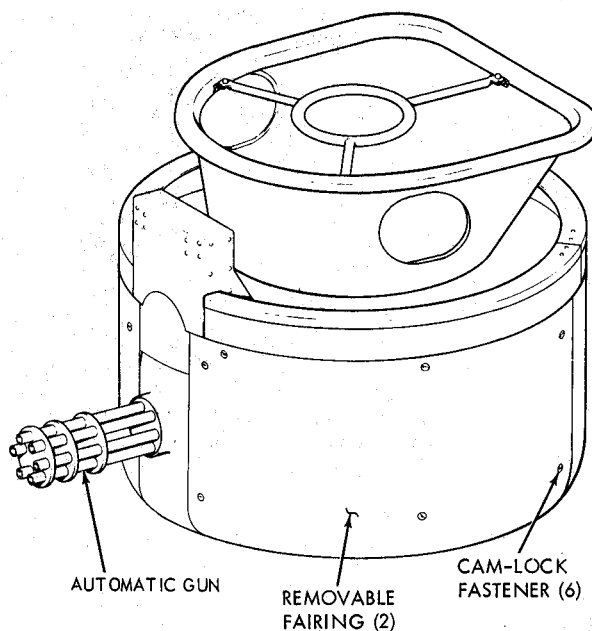

209071-7A

Figure 6-7. Turret assembly

**Warning**

Do not manually rotate barrel assembly because gun may fire.

6-42. The turret hydraulic pressure is boosted momentarily by the turret system pressure intensifier assembly. The pressure from the intensifier assembly is released each time the turret trigger switch is actuated. When the turret firing circuit is energized the intensifier provides a hydraulic pressure boost (3000 psi) for the gun drive motor initial starting torque.

6-43. Deleted.

6-44. **Electronic Control Subassembly.** The electronic control subassembly (figure 6-8) is located below the gunner's control panel in the

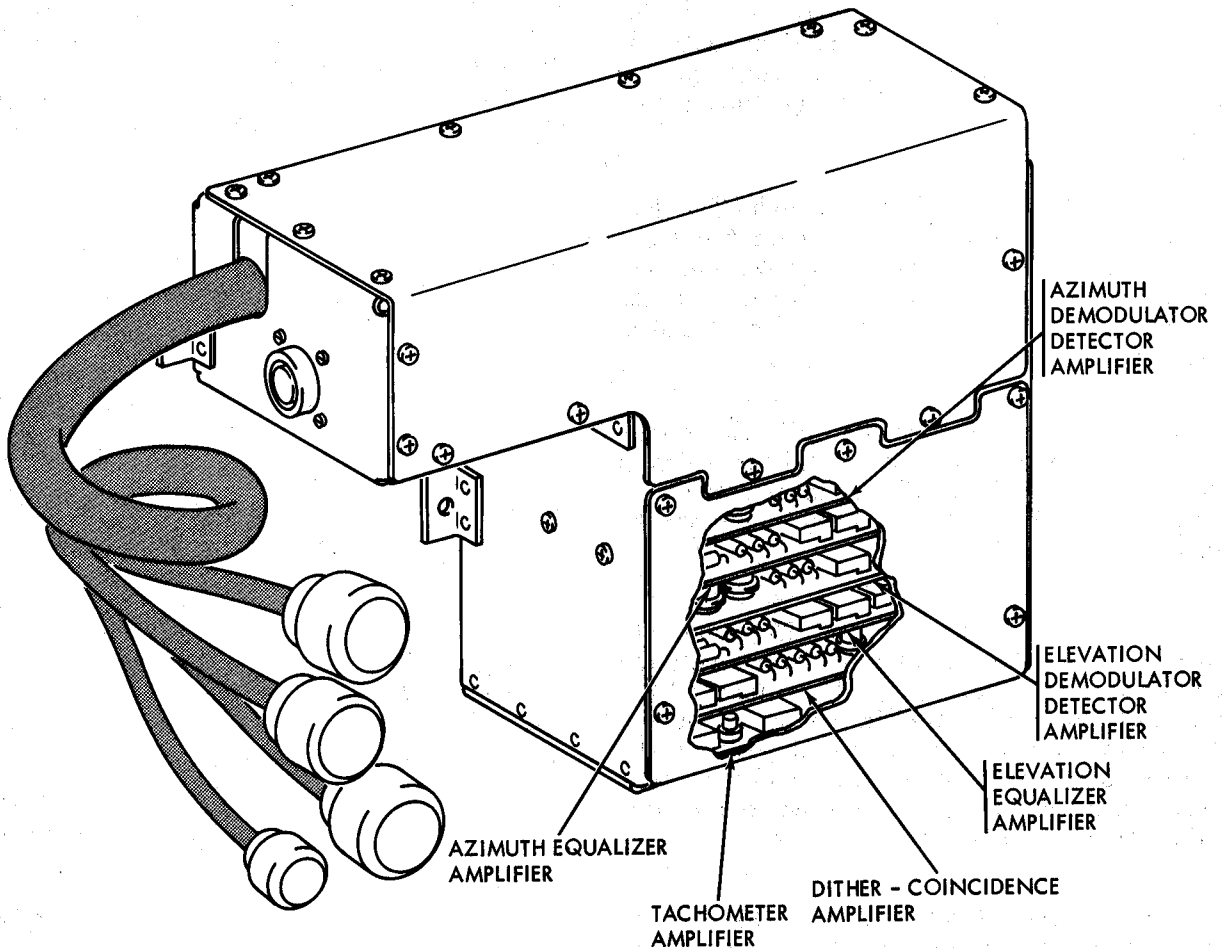

Figure 6-8. Electronic control subassembly

209071-8

gunner station. The subassembly contains amplifiers, relays and electronic components utilized by the control circuit, firing circuit, and master armed bus. Located in the subassembly are six removable plug-in circuit card assemblies which provide control and amplification of turret assembly control signals.

**6-45. Ammunition Feed System.** The ammunition stowage and feed system (figure 6-9) is used to store 8000 rounds of 7.62 mm ammunition in standard metal links, and transports the ammunition to the gun. Each link is separated from the cartridge and belt, and is discarded at the gun feeder prior to entry into the gun chamber.

**6-46.** The ammunition feed system consists of the following items: four rectangular compartmented, metallic ammunition stowage boxes, a crossover mechanism, a feed chute and a synchronized cartridge drive assembly.

a. **Ammunition Stowage Boxes.** Each ammunition stowage box is divided into two bays; each bay is divided into two compartments. Each ammunition box has two spring loaded handles. A lid covers all four boxes.

b. **Crossover Mechanism.** The crossover mechanism is attached to the rear of the ammunition boxes. The crossover mechanism connects each bay of ammunition and forms a continuous transportation path between adjacent stowage boxes. The crossover mechanism contains four separately engaged sprockets which are driven by the synchronized cartridge drive assembly. Three idler rollers are located at the bottom of the crossover for guiding the ammunition through the crossover. Three detent switches are located above the rollers for engaging the sprocket clutches. The crossover mechanism also contains a last round switch and a rounds counter switch.

c. **Feed Chute.** A flexible ammunition feed chute guides the selected path of the ammunition from the exit of the crossover to the gun feeder. The chute allows the ammunition to be delivered to the weapon in any of its azimuth and elevation positions.

d. **Synchronized Cartridge Drive Assembly.** A flexible shaft connects the cartridge drive assembly to the gun drive. This shaft synchronizes the extraction and transportation of

cartridges to gun fire demand, ensuring no gun stoppage due to different acceleration or feed rates between separate cartridge drives and the gun.

e. **Ammunition Feed System Operation.** Ammunition is fed from the stowage boxes in the following manner. Cartridges are extracted from the ammunition box compartments in sequence. Cartridges in the successive compartment are immobile until all cartridges in the preceding compartment are depleted. Upon depletion of the first bay, the tension on the idler roller in the crossover trips the detent switch and engages the clutch for the next bay sprocket drive. Ammunition flows over the extracting sprocket, around the lower (idler) roller, over the primary drive sprocket, through the feed chute and into the gun until all boxes are emptied. As the last cartridge of the ammunition belt passes over the last round switch, gun firing and ammunition feed is automatically stopped and the cartridge belt is left in the feed chute with its last round accessible for joining to the cartridge in a reloaded box. A rounds counter switch electrically counts the number of rounds fired and relays the information to the AMMO PERCENT REMAINING meter.

### 6-47. Leading Particulars.

#### ARMAMENT SYSTEM

Weight (including ammunition) .....	767 lbs.
Power Requirements	
Electrical .....	28 VDC at 28 amperes 115 volts 400 cycles
Hydraulic .....	1500 psi at 5.8 gpm (MIL-H-5606 fluid)

#### TURRET

Movement	
Azimuth .....	115° left, 115° right
Elevation .....	Variable, dependent on azimuth position

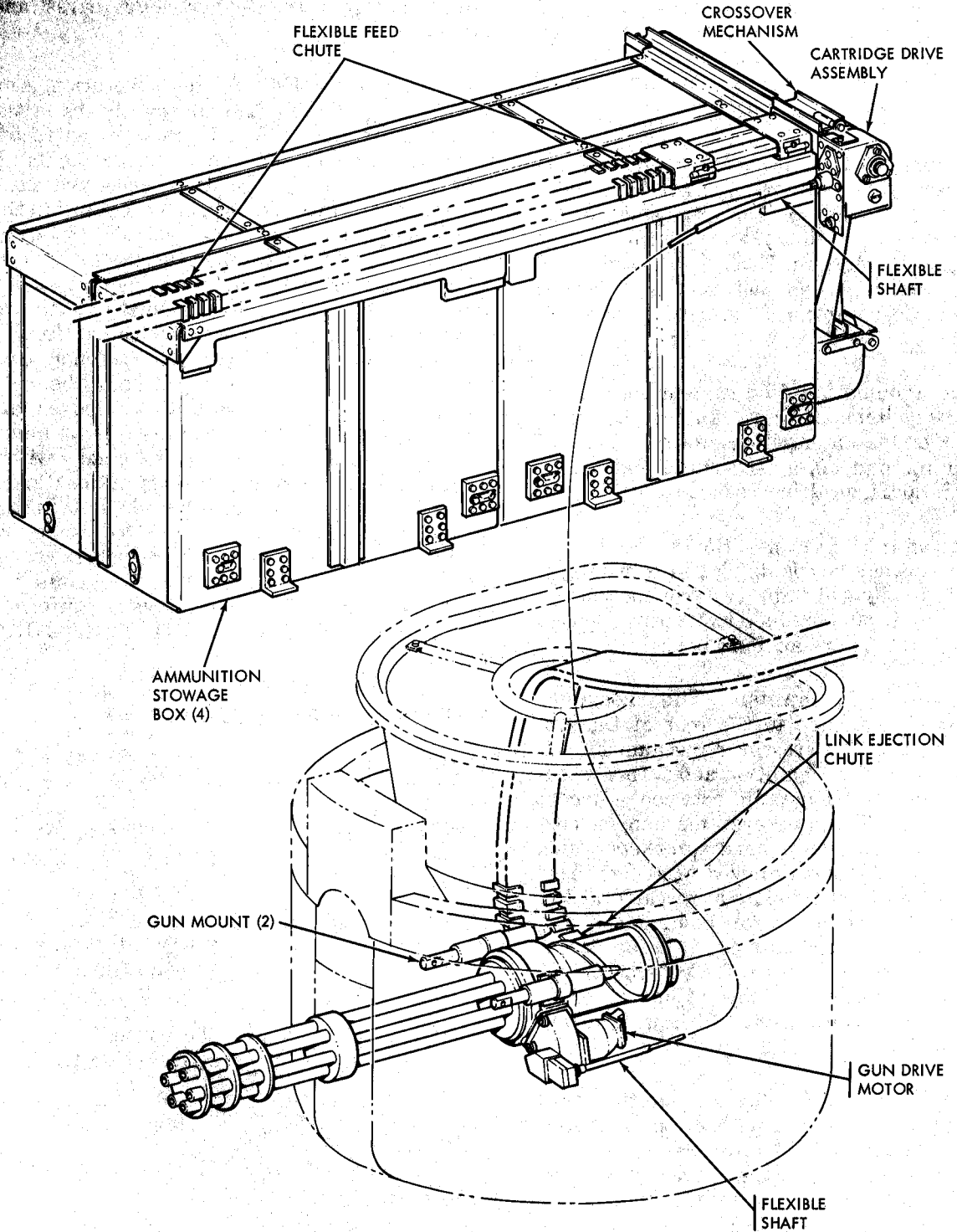

209071-9

Figure 6-9. Ammunition feed system

Azimuth Position	Elevation
0°	20°
25°	23°
35°	24°
45°	25°
60°	24°
90°	19°
115°	15°

**6-49. Pilot's Operating Procedures. a. Preliminary Procedure.**

(1) Place pilot's MASTER ARMED switch in the ON position.

(2) Place pilot's CONTROL SELECTOR switch in the PILOT position.

**b. Operating Procedures.**

(1) Place POINT-AREA FIRE switch in either the POINT or AREA position. Position of switch is dependent on intended use.

(2) To fire turret gun, depress trigger switch on cyclic control.

Depression ..... 50°

Angular Velocity

Azimuth ..... 80° per second

Elevation ..... 60° per second

**GUN (GAU-2B/A)**

Caliber .....	7.62 mm
Firing rate	
Low .....	1300 rounds per minute (plus or minus 400 rounds)
High .....	4000 rounds per minute (plus or minus 400 rounds)
Operation .....	fixed or flexible
Rounds .....	8000 stored in ammunition boxes

**Note**

Partially depressing trigger switch will fire the gun at a low rate of speed (1300 rounds per minute). Completely depressing the trigger switch will fire the gun at a high rate of speed (4000 rounds per minute).

(3) To fire wing stores, select inboard or outboard wing stores using POD SELECT switch and depress Thumb button on cyclic control.

(4) Prior to returning to base, place the CONTROL SELECTOR and MASTER ARMED switches in the OFF position.

**Note**

After landing, place the INVERTER switch and the circuit breakers in the OFF position.

**6-50. Gunner's Operating Procedures. a. Preliminary procedures.**

**Note**

The pilot's MASTER ARMED switch must be in the ON position. The pilot's CONTROL SELECTOR switch must be in the GUNNER position. Observe that SYSTEM ARMED indicator and GUNNER CONTROL indicator are illuminated.

(1) If use of the armament subsystem is anticipated, place the TURRET POWER switch

**Caution**

Do not use fluted case dummy cartridges.

**6-48. Normal Operating Procedures.**

**Note**

The aircraft armament circuit breakers and INVERTER switch must be in the fwd (ON) position.

in the fwd position to warm up amplifiers. Observe that TURRET POWER indicator is illuminated.

(2) Disengage sight station gimbal locks.

(3) Place sight station ground safety lever in up position.

**Caution**

Depression of the sight head will cause the barrel assembly to strike the ground resulting in damage to the turret.

b. Operating Procedures.

(1) Place TURRET MODE switch in either POINT or AREA position. Position of switch is dependent upon intended use.

(2) For combat mission, place WPN UNCLR-WPN CLEAR switch in UNCLR position. For training mission, place switch in WPN CLEAR position.

(3) Place compensation switch in IN position if gun line correction for air speed and range is desired.

(4) Index estimated range on RANGE ADJUST knob (applicable only if compensation switch is at IN position).

(5) Depress action switches and move sight to position target in reticle image.

(6) Fire gun.

(a) For low rate of fire, depress the low rate firing triggers.

(b) For high rate of fire, depress low rate firing triggers; then depress high rate firing buttons.

**Note**

If gun ceases firing due to ammunition being expended from ammunition stowage boxes, place the FIREOUT switch to the fwd position to allow ammunition in flexible chute to be fired.

(7) Prior to returning to base, place WPN UNCLR-WPN CLEAR switch in WPN

CLEAR position and fire gun for short burst. Observe that WPN UNCLR indicator is not illuminated.

**6-51. Emergency Operating Procedure.** The emergency procedures for the automatic gun are covered in the following three paragraphs.

**6-52. Gunner's Emergency Procedures.** (Pilot disabled). a. Place PILOT OVERRIDE switch in fwd position.

b. To fire gun, depress trigger switch on cyclic control.

**Note**

Partially depressing trigger switch will fire gun at a low rate of speed (1800 rounds per minute). Completely depressing the trigger switch will fire the gun at a high rate of speed (4000 rounds per minute).

c. To fire wing stores, select inboard or outboard wing stores using WING STORES switch and depress thumb button on cyclic control.

d. Prior to returning to base, place PILOT OVERRIDE switch in OFF position.

**6-53. Pilot's Emergency Procedure (Runaway Gun).** In the event of a runaway gun, place MASTER ARMED switch in the OFF position.

**6-54. Pilot's Emergency Procedure (No. 2 Hydraulic System Failure).** Should a hydraulic failure occur, gun will remain in azimuth when failure occurred but will return to zero (stow position) elevation or higher. Gunner should visually check azimuth position of gun and advise pilot, as gun will not be cleared and necessary precautions must be taken.

**6-55. Operation — Preflight Check.** Perform the following operations.

a. EXTERIOR CHECKS.

(1) 7.62mm automatic gun — Secure.

(2) Ammunition box assemblies—Loaded.

(3) Electrical connectors — Connected.

(4) Hydraulic connectors — Connected.

(5) Flexible shaft and ammunition chute — Connected.

b. INTERIOR — PILOT.

- (1) Clear area in front of helicopter.
- (2) MASTER ARM switch — OFF.

c. INTERIOR — GUNNER.

- (1) TURRET POWER switch — OFF.
- (2) WING STORES switch — OFF.
- (3) PILOT OVERRIDE switch — OFF.
- (4) AMMO FIREOUT switch — OFF.
- (5) WPN UNCLR-WPN CLEAR switch — WPN CLEAR.
- (6) AMMO RESERVE PERCENT meter — 100.
- (7) Indicator lights — Illuminate.
- (8) Sighting Station — Stowed.
- (9) Ground Safety Lever — Down.

**6-56. Inflight Operation.** To fire the TAT-102A turret system perform the following operations.

a. PILOT. (Pilot to fire gun).

- (1) MASTER ARM switch — ON.
- (2) TURRET CONT switch — PILOT.
- (3) TURRET MODE switch — Select.
- (4) Cyclic Turret switch — Depress.

b. GUNNER. (Gunner to fire gun).

- (1) TURRET CONT switch (Pilot's) — GUNNER.
- (2) MASTER ARM switch (Pilot's) — ON.
- (3) TURRET POWER switch — fwd (ON).

(4) Sight Station Gimbal Locks — Disengage.

(5) Sight Station Ground Safety Lever — Up.

(6) TURRET MODE switch — Select.

(7) WPN UNCLR-WPN CLEAR switch — Select.

(8) COMPensation switch — Select.

(9) Range Adjust Knob — Adjust.

(10) Action switch — Depress as required.

(11) Low Rate Firing Trigger — Depress as required.

(12) High Rate Firing Button — Depress as required.

**6-57. Inflight — Turret Securing.** Perform the following prior to returning to operational base.

a. GUNNER.

(1) WPN UNCLR-WPN CLEAR switch — WPN CLEAR.

(2) Action switch — Momentarily depress.

(3) Low Rate Firing Trigger — Momentarily depress.

(4) Sight Station Ground Safety Lever — Down.

(5) Sight Station Gimbal Locks — Engaged.

(6) TURRET POWER switch — OFF.

b. PILOT.

(1) TURRET CONT switch — OFF.

(2) MASTER ARMED switch — OFF.

**6-58. Before Leaving Helicopter.** Perform the following operations.

a. PILOT.

(1) MASTER ARM switch — OFF.

(2) TURRET CONT switch — OFF.

b. GUNNER.

- (1) TURRET POWER switch — OFF.
- (2) WING STORES switch — OFF.
- (3) PILOT OVERRIDE switch — OFF.
- (4) AMMO FIREOUT switch — OFF.
- (5) WPN UNCLR-WPN CLEAR switch — WPN CLEAR.
- (6) Sighting Station — Stowed.
- (7) Ground Safety Lever — Down.

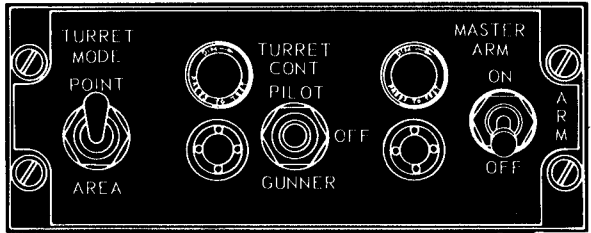

209075-4

Figure 6-11. Pilot's turret control panel

firing the TAT-102A turret in the stowed position and podded guns and rockets on the wing stores.

**6-61. Cyclic Stick Armament Switches.** The cyclic stick provides two armament switches: Wing Stores and Turret (see figure 6-10).

**6-62. Wing Stores.** The lower thumb button on the cyclic stick is used to fire the wing stores. After presetting the wing stores selection switch, the wing stores may be fired. An interrupter circuit is installed to interrupt the turret firing when the thumb button is depressed.

**6-63. Turret.** The turret trigger switch will fire the turret mounted gun. The pilot may fire the turret, at his discretion, when the turret is in the stowed position. When the gunner has the turret in a slew mode, the pilot cannot fire the turreted gun. The pilot may override the gunner at any time by actuating the TURRET CONT switch to the PILOT position. When this switch is actuated, the turret will return to stow and the pilot will have control. The gun may then only be fired from the pilot and gunner cyclic triggers.

**6-64. Pilot's Turret Control Panel.** The pilot's turret control panel (see figure 6-11) is located at the forward area of the pilot's station. The control panel contains the following: TURRET MODE switch, indicator light, TURRET CONT switch, indicator light and MASTER ARM switch. The functions of the switches and indicator lights are as follows:

**6-60. Pilot Sighting Station.** The pilot is provided with a fixed illuminated reticle sight for

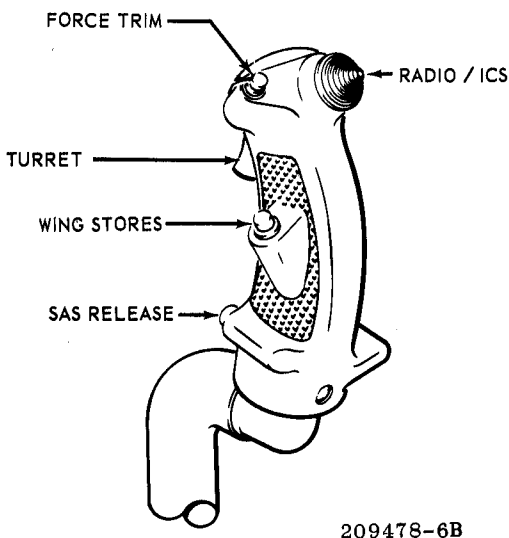

209478-6B

Figure 6-10. Cyclic stick armament switches



<u>CONTROL OR SWITCH INDICATOR</u>	<u>POSITION</u>	<u>FUNCTION</u>	<u>CONTROL OR SWITCH INDICATOR</u>	<u>POSITION</u>	<u>FUNCTION</u>
TURRET MODE (Switch)		This is a two position switch: POINT — AREA	MASTER ARM (Light)		This light illuminates (amber) when the MASTER ARM switch is in the ON position, and the armament systems are in standby.
	POINT	With the switch in this position, the gun is slaved to the sight.			
	AREA	With the switch in this position, the gun oscillates laterally to give a scattered lateral pattern on the selected area. Switch will override gunner's selection.			
TURRET CONT (Light)		This light illuminates (blue) when the TURRET CONT switch is in the PILOT'S position. Authority for this light is TURRET CONT switch.	MASTER ARM (Switch)	ON	This position arms the basic weapons systems including wing stores, turret, and smoke grenade dispenser. These weapons are, however, not hot until the following three switches are energized, TURRET CONT, WG STS ARM and SMK GRENADE.
				OFF	This position de-energizes the armament circuits.
TURRET CONT (Switch)		This is a three position switch. PILOT-OFF-GUNNER.	MASTER ARM (Switch)		This is a two position (guarded) switch: ON-OFF.
	PILOT	With the switch in this position the turret is hot and the pilot has control.			
	OFF	Turret power is "OFF".			
	GUNNER	With the switch in this position the turret is hot and the gunner has control.			

**6-65. Pilot's Wing Stores Control Panel.** The pilot's wing stores control panel (figure 6-12) is located in the forward area of the pilot's station. The control panel contains the following: Armed light, WG STS Jettison switch, RKT PR SEL switch, WG STS Arm switch and SMK Grenade switch. The function of the switches and indicator lights are as follows:

<u>CONTROL OR INDICATOR</u>	<u>SWITCH POSITION</u>	<u>FUNCTION</u>	<u>CONTROL OR INDICATOR</u>	<u>SWITCH POSITION</u>	<u>FUNCTION</u>
ARMED (Light)		This indicator light will illuminate (amber) when the Wing Stores Arm switch is in the OUTBD or INBD position.	WGS STS ARM (Switch)		fired in pairs according to the preselected position of the switch.
	WG STS JETTISON (Switch)	This is a three position Wing Stores jettison lever lock switch with the following positions: OUTBD, OFF and INBD.			This is an arm toggle switch with three positions as follows: OUTBD, OFF and INBD.
	OUTBD	This position jettisons the outboard wing stores.		OUTBD	This position arms the outboard wing stores.
	OFF	This position deactivates the wing stores jettison system circuit.		OFF	This position deactivates the wing stores arm circuit.
	INBD	This position jettisons the inboard wing stores.		INBD	This position arms the inboard wing stores.
RKT PR SEL (Switch)		This is a rotary rocket pair selector switch with five positions as follows: 1, 2, 4, 7 and 19.	SMK GRENADE (Switch)		This is a momentary, spring loaded center position, Fire No. 1, OFF and Fire No. 2.
	1	This position energizes the wing stores circuit to fire one pair of rockets.		FIRE NO. 1	This position drops colored smoke grenade that is controlled by the No. 1 circuit.
	2, 4, 7 and 19	With selector in these positions the quantity of rockets are		OFF	This position deactivates the smoke grenade circuit.
				FIRE NO. 2	This position drops colored smoke grenade that is controlled by the No. 2 circuit.

**6-66. External Stores.** Four attachment points are provided, two under each wing panel. These are located 42.5 inches and 60.0 inches from the center line of the helicopter.

**6-67. Pylons.** The pylon assemblies include special 14 inch external store racks, sway braces and standard electrical connections for the external stores. The entire assembly is enclosed in a fairing that matches the lower contour of the wing. Primary and emergency electrical jettison provisions are provided for the gunner.

**6-68. Pods.** The external stores for the helicopter are listed in the following paragraphs.

**6-69. Rockets.** The 2.75 inch folding fin aerial rockets (FFAR) are carried in either a 19 tube rocket pod or a 7 tube rocket pod. The wing stores will provide for a maximum of four 19 tube pods — 76 rockets.

**6-70. Guns.** Provisions are included for the XM-18 automatic gun pod at each inboard station. This pod has the 7.62 mm automatic gun installed with a self-contained electric power supply. Each pod carries 1500 rounds and is fired at a 4000 rounds per minute rate. These fixed guns are aimed by flying the helicopter directly at the target.

**6-71. Rocket Launcher — XM-157.** The XM-157 launcher is reusable. It fires seven 2.75 inch FFAR's. The wings have two hard point locations on each wing which provides locations for four XM-157 launchers. See figure 6-13 for rocket firing order.

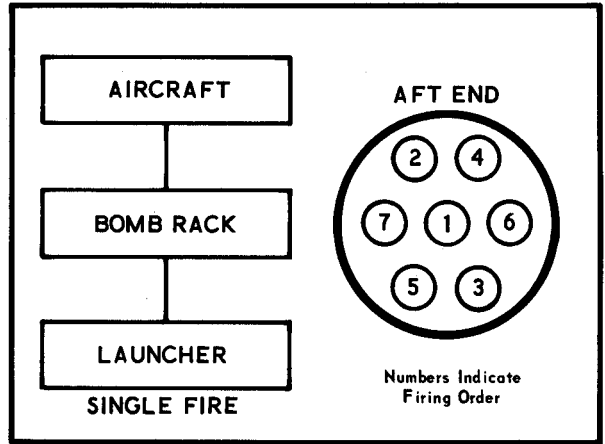

209071-1

Figure 6-13. XM-157 rocket launcher firing order

**6-72. Rocket Launcher — Tabulated Data.**

Weight per Launcher (Empty)	51.5 pounds
Weight per Launcher (Loaded)	202.5 pounds
Capacity (2.75 inch FFAR)	7 rockets
Cross Section	9.8 in. Diam.
Length	49.87 inch

**6-73. Controls.** The pilot and gunner are provided with controls for operation of the wing stores armament. The primary controls are located on the pilot's left console. The gunner's armament control panel is located in his right console. The gunner's panel has a POD SELECT switch and a PILOT OVERRIDE switch. The pilot has a MASTER ARM switch, POD SELECT switch and ROCKET PAIR SELECT switch.

**6-74. Operation — Preflight Check.** Perform the following operations:

- a. INTERIOR — GUNNER.
  - (1) Clear area in front of helicopter.
  - (2) WING STORES switch — OFF.

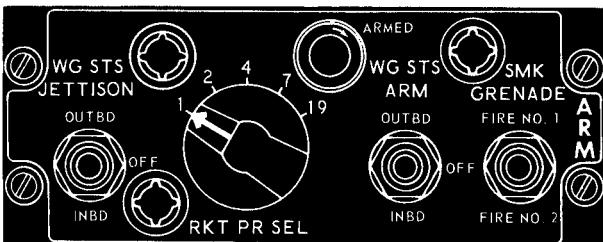

209075-3A

Figure 6-12. Pilot's wing stores control panel

(3) PILOT OVERRIDE switch — OFF.

b. INTERIOR — PILOT.

(1) Clear area in front of helicopter.

(2) WG STS JETTISON switch — OFF.

(3) RKT PR SEL switch — As desired.

(4) WG STS ARM switch — OFF.

(5) MASTER ARM switch — OFF.

c. EXTERIOR.

(1) Rockets loaded and detents secure.

(2) Check that arming procedures have been completed and electrical connection between helicopter and launcher is connected.

**6-75. Inflight Operation.** Perform following operations.

- a. WING STORES circuit breaker — IN.
- b. MASTER ARM switch — ON.
- c. RKT PR SEL switch — As desired.
- d. WG STS ARM switch — OUTBD or INBD.
- e. Align fixed sight on target.
- f. Depress cyclic firing thumb button.

**Warning**

Failure to fire may result if the firing switch is not closed for at least one-tenth of a second.

**6-76. Before Leaving Helicopter.** Perform following operations.

- a. WG STS ARM switch — OFF.
- b. MASTER ARM switch — OFF.
- c. WING STORES circuit breakers — OUT.

**6-77. Rocket Launcher — XM-159.** The 159 launcher is reusable. It fires nineteen 2.75 inch

FFAR's. The wings have two hard point locations on each wing which provides for XM-159 launchers. See figure 6-14 for rocket firing order. When both the XM-157 and XM-159 launchers are installed the XM-159 launchers shall be on the inboard hard points.

**6-78. Rocket Launcher — Tabulated Data.**

Weight per Launcher (Empty)	102 pounds
Weight per Launcher (Loaded — 6 lb. warhead)	512 pounds.
Capacity (2.75 inch FFAR)	19 rockets
Cross Section	15.5 inch diam.
Length	49.87 inches

**6-79. Operation — Preflight Check.** Refer to paragraph 6-74.

**6-80. Inflight Operation.** Refer to paragraph 6-75.

**6-81. Before Leaving Helicopter.** Refer to paragraph 6-76.

**6-82. Gun Pod — XM-18.** The XM-18 gun pod houses a 7.62 mm automatic gun. The gun pod is carried on the inboard hard points of

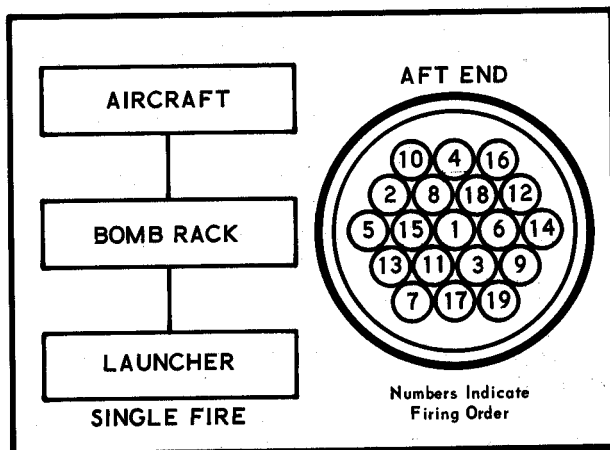

Figure 6-14. XM-159 rocket launcher firing order

each wing. The gun pod carries its own electrical system and space for 1500 rounds of 7.62 mm ammunition. The pod is a self-contained unit with a battery recharging system.

**6-83. Gun Pod — Tabulated Data.**

Weight Empty (each pod)	245 pounds
Weight Loaded (each pod)	378 pounds
Length	85 inches
Diameter	12 inches
Maximum Burst Length	Full Complement
Capacity	1500 rounds
Gun and Feed System	Electric

**6-84. Operation — Preflight Check.** Perform the following operations:

a. INTERIOR — GUNNER.

- (1) Clear area in front of helicopter.
- (2) POD SELECT switch — OFF.
- (3) PILOT OVERRIDE switch — OFF.

b. INTERIOR — PILOT.

- (1) Clear area in front of helicopter.
- (2) WGS STS JETTISON switch — OFF.
- (3) WGS STS ARM switch — OFF.
- (4) WING STORES circuit breakers — IN.
- (5) MASTER ARM switch — OFF.

c. EXTERIOR.

(1) Check pod for general condition and security.

(2) Check for correct indicator reading (quantity of rounds).

**6-85. Inflight Operation.** Perform following operations:

- a. WING STORES circuit breakers — IN.
- b. MASTER ARM switch — ON.
- c. WG STS ARM switch — INBD.
- d. ARMED light — Illuminated.
- e. Align fixed sight on target.
- f. Depress cyclic firing thumb button.

**6-86. Before Leaving Helicopter.** Perform following operations.

- a. WG STS ARM switch — OFF.
- b. MASTER ARM switch — OFF.
- c. WING STORES circuit breakers — OUT.

**6-87. Operation.** The weapon system of the helicopter can be used in the following modes of operation.

**Rocket and Flex Turret** This mode of operation allows the gunner to select a separate target while the pilot is firing the rockets. The pilot uses his fixed sight and estimates the range. The gunner is able to fire the automatic gun at both 1300 and 4000 rounds per minute. The rocket fire switch will momentarily cut off the gun fire to prevent the bullets from hitting the rockets.

**Turret Flex** This mode of operation allows the gunner full control of turret and gun.

**Turret Stowed** The chin turret is stowed in both azimuth and elevation to a predetermined bore sight reference. If the gunner is flying the helicopter he can fire the gun from this fixed position at both 1300 and 4000 rounds per minute. The gunner must use a reference of some type (i.e. grease pencil mark on windshield) and must correct fire by tracers

or impact reference. The pilot may also fire in this mode with the aid of his fixed sight.

Gun Pod

When gun pods are carried (inboard wing stores only) the pilot fires them essentially the same way as rockets. The pilot's fixed sight is bore-sighted to the wing pods. The flex turret will be cut out when the gun pods are fired.

Rocket and Stowed Turret

The cyclic stick trigger switch will fire the gun at 1300/4000 rounds per minute. The gun fire is momentarily cut off when rockets are fired. The quantity of rockets fired must be predetermined by the RKT PR SEL switch.

**6-88. Missions.** Typical mission configurations, armament panel switch position and fire power is as follows:

**Rocket Run — Turret Flex**

SWITCH	POSITION	LOCATION	FUNCTION
MASTER ARM	ON	Pilot's Turret Control Panel	<p>Pilot's cyclic stick thumb button (see figure 6-11) fires rockets. When pilot depresses thumb button turret gun fire is interrupted. Gunner has turret freedom at 1300/4000 rounds per minute using sight trigger switch or cyclic trigger switch. The first detent fires 1300 rounds per minute and the second detent fires 4000 rounds per minute.</p> <p style="text-align: center;"><b>Note</b></p> <p>When the TURRET CONT is in the GUNNER position the gunner's TURRET MODE switch has priority over the pilot's TURRET MODE switch.</p>
TURRET CONT	GUNNER	Pilot's Turret Control Panel	
TURRET MODE	POINT or AREA	Gunner's Armament Control Panel	
TURRET POWER	Fwd (ON)	Gunner's Armament Control Panel	
AMMO FIRE OUT	ON or OFF as desired	Gunner's Armament Control Panel	
WPN UNCLR-WPN CLEAR	WPN CLEAR or WPN UNCLR as desired	Gunner's Armament Control Panel	
WG STS ARM	OUTBD or INBD (as dictated by rocket loading)	Pilot's Wing Stores Armament Panel	
RKT PR SEL	1, 2, 4, 7 or 19 (as required by fire power)	Pilot's Wing Stores	

**Turret Run — Turret Flex**

SWITCH	POSITION	LOCATION	FUNCTION
TURRET CONT	GUNNER	Pilot's Armament Control Panel	<p>The gunner has control of turret. Turret can be actuated and will fire 1300/4000 rounds per minute. Sight and cyclic stick switches are armed. First detent fires 1300 and second detent fires 4000 rounds per minute.</p> <p style="text-align: center;"><b>Note</b></p> <p>When the TURRET CONT is in GUNNER position the gunner's TURRET MODE switch has priority over the Pilot's TURRET MODE switch.</p>
MASTER ARM	ON	Pilot's Armament Control Panel	
TURRET POWER	Fwd (ON)	Gunner's Armament Control Panel	
TURRET MODE	POINT or AREA (as desired)	Gunner's Armament	
AMMO FIREOUT	ON or OFF (as desired)	Gunner's Armament Control Panel	
WPN UNCLR-WPN CLEAR	WPN UNCLR or WPN CLEAR (as desired)	Gunner's Armament Control Panel	

**Rocket Run — Fixed Turret**

SWITCH	POSITION	LOCATION	FUNCTION
TURRET MODE	POINT or AREA as desired	Pilot's Armament Control Panel	<p>Pilot cyclic trigger fires 1300/4000 rounds per minute and turret fire can be used for target marking. Thumb button automatically interrupts turret gun firing to fire rockets. Turret is held in stowed position.</p> <p style="text-align: center;"><b>Note</b></p> <p>When the TURRET CONT is in PILOT position the pilot's TURRET MODE switch has priority over the gunner's TURRET MODE switch.</p>
TURRET CONT	PILOT	Pilot's Armament Control Panel	
MASTER ARM	ON	Pilot's Armament Control Panel	
RKT PR SEL	1, 2, 4, 7 or 19 (as required by fire power)	Pilot's Wing Storage Armament Panel	
WG STS ARM	OUTBD or INBD (as dictated by rocket loading)	Pilot's Wing Stores	

**6-89. Target Marking.** Two smoke grenade dispensers are located in the aft fuselage and holds six smoke grenades each. The dispensers

may be individually selected and fired by a switch on the Pilot's Wing Stores Control Panel (see figure 6-12).

### Section VIII — Photographic Equipment

(Not Applicable)

### Section IX — Aerial Delivery Equipment

(Not Applicable)

### Section X — Miscellaneous Equipment

**6-90. Data Case.** A data case for maps, flight reports and etc. has been provided. The data case is located beneath the pilot's seat.

**6-91. Mooring Fittings.** The mooring fittings are provided on the helicopter fuselage and at each outboard wing stores. One fitting is located on the fuselage just forward of the tail boom attachment fittings and one fitting is located aft of the chin turret. These fittings are accessible when their access plate has been removed. The wing stores fitting is installed in the outboard racks discharge cartridge location. All mooring fittings are of the dual purpose jackpoint and mooring fitting.

**6-92. Tow Rings.** To facilitate towing the helicopter, with ground handling wheels lowered, a tow ring has been provided at the forward end of each landing gear skid tube. These rings will receive a standard tow bar.

**6-93. Rotor Tie Down.** Rotor tie down is provided for use in mooring the aft blade of the main rotor. To prevent the rotor from seesawing when the helicopter is parked. The tie down can be stowed in the gunner's compartment.

**6-94. Pitot Tube Cover.** A cover for the pitot tube is supplied. This cover is made of olive drab duck material. The cover has a streamer to warn personnel. The streamer is printed with "REMOVE BEFORE FLIGHT."

**6-95. Tail Pipe Cover And Engine Inlet Shield.** Covers are provided of olive drab, duck material to cover the engine inlet and tail pipe during storage or tie down. Streamers are sewed on to warn personnel to remove before flight. The engine inlet shield is of polyurethane foam covered with duck material. The shield is held in place by compressing the shield into the engine inlet openings.

**6-96. Canopy Cover.** A canopy cover is provided to cover the transparent area of the crew compartment. The cover is made of cotton twill material and is held in place by four nylon cords. Stencils are located at the forward outside edges to indicate the forward edge of cover.

**6-97. Electrical External Stores Jettison.** An electrical jettison assembly is attached to both of the right and left wing store supports. The electrical release assemblies are activated by a jettison switch located on the pilot's armament panel. Emergency electrical jettison switches for both pilot and gunner are located on the left side of the respective instrument panels. This emergency system is independently wired to the battery bypassing the battery ON-OFF switch. The inboard pylon incorporates an electrically primed cartridge used to force eject the stores under a 6 G for a loaded XM-159 pod. The inboard stores eject at a 34 degree angle outboard to clear the skid gear and outboard pod. The outboard stores ejects a fully loaded XM-159 with a 2 G force in a vertical plane.



**CHAPTER 7**  
**OPERATING LIMITS**

**Section I — Scope**

**7-1. Scope of Operating Limitations Data.** All important limitations that must be observed during normal operations of the helicopter are provided in this Chapter.

**7-2.** Limitations that are characteristic only to a specialized phase of operation are not repeated here.

**Section II — Limitations**

**7-3. Introduction.** The flight and engine limitations set forth in this Chapter are the direct result of numerous flight test programs and actual operation experiences. Compliance with these limits will allow YOU, THE PILOT, to safely perform the assigned missions and permit YOU to derive maximum utility from the helicopter, when used for intended purpose. Limits concerning maneuvers, "CG" and "G" loadings are also covered in this Chapter. Close attention must be given to the instrument markings, since they represent limitations that are not necessarily repeated in the text. The operating limits decal (see figure 7-1) will serve as a constant reminder during operations.

**7-4. Minimum Crew Requirements.** The minimum crew requirements for the tactical helicopter consists of only the pilot. The pilot can control all fire power from the aft cockpit. For better fire power coverage and control however, the mission should carry a gunner and a pilot. With a gunner the flexible capability of the turret gun can be employed.

**7-5. Instrument Markings.** The operating ranges for both the helicopter and engine are listed below and shown on figure 7-2

OPERATING LIMITS		
DENSITY ALTITUDE FEET	AIRSPEED KNOTS	
	XM 159	
324 RPM	W/O	WITH
SL-3000	190	180
6000	170	156
9000	150	130
12000	130	110
15000	100	90
REDUCE AIRSPEED IF VIBRATION EXCESSIVE		

209070-11

Figure 7-1. Operating limits decal

**INSTRUMENT MARKINGS**

**FUEL GRADE  
JP-4 or JP-5**



**FUEL PRESSURE**

■ 5 to 20 PSI Continuous Operation



**ENGINE OIL PRESSURE**

■ 25 PSI Minimum  
■ 100 PSI Maximum



**ENGINE OIL TEMPERATURE**

■ 93 °C Maximum



**TRANSMISSION OIL PRESSURE**

■ 30 PSI Minimum  
■ 40 to 60 PSI Continuous Operation  
■ 70 PSI Maximum



**TRANSMISSION OIL TEMPERATURE**

■ 110 °C Maximum

209078-12-1A

*Figure 7-2. Instrument markings (Sheet 1 of 2)*

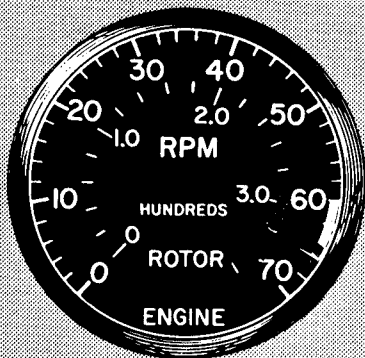

**ROTOR TACHOMETER**

- █ 294 to 324 RPM Continuous Operation
- █ 339 RPM Maximum for Autorotation

**ENGINE TACHOMETER**

- █ 6000 to 6400 RPM 0 - 70 Knots
- █ 6400 to 6600 RPM Continuous Operation
- █ 6600 RPM Maximum

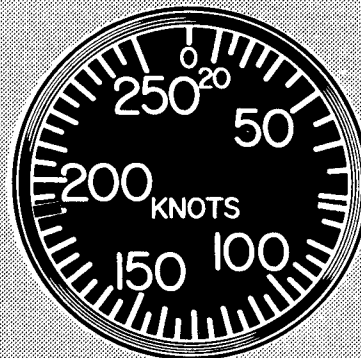

**AIRSPEED**

- █ Above 70 Knots - 6400 RPM Minimum

- █ 190 Knots Maximum

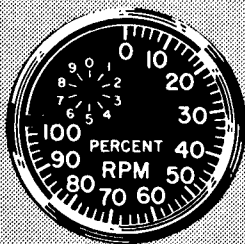

**GAS PRODUCER TACHOMETER**

- █ 101.5 Percent Maximum

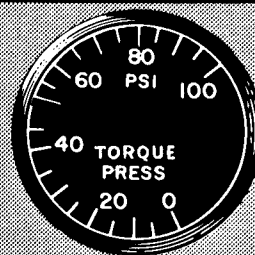

**TORQUE PRESSURE**

- █ 50 PSI Maximum

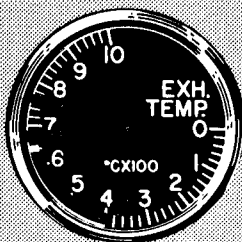

**EXHAUST TEMPERATURE**

- █ 400°C to 625°C Continuous Operation
- █ 625°C to 645°C 30 Minute Limit
- █ 675°C 5 Second Limit for Starting and Acceleration
- █ 760°C Maximum for Starting and Acceleration

**FUEL GRADE  
JP-4 or JP-5**

Figure 7-2. Instrument markings (Sheet 2 of 2)

**Fuel Pressure**

5 to 20 psi Continuous operation

**Engine Oil Pressure**

25 psi Minimum  
100 psi Maximum

**Engine Oil Temperature**

93°C Maximum

**Engine Tachometer**

6000 to 6400 rpm  
6400 to 6600 rpm Continuous Operation  
6600 rpm Maximum

**Gas Producer**

101.5 Percent rpm Maximum

**Engine Exhaust Temperature**

400°C to 625°C Continuous Operation  
625°C to 645°C 30 minute limit  
675°C 5 second limit for starting and acceleration  
760°C Maximum for starting and acceleration

**Torque Pressure**

50 psi Maximum

**Transmission Oil Pressure**

30 psi Minimum  
40 to 60 psi Continuous Operation  
70 psi Maximum

**Transmission Oil Temperature**

110°C Maximum

**Rotor Tachometer**

294 to 324 rpm Continuous operation  
339 Maximum for autorotation

**Airspeed**

190 Knots maximum

**7-6. Engine Limitations.** The T53-L-13 gas turbine power plant in this installation is rated to an output torque value equivalent to 1400 hp at 6600 rpm for military rating and 1250 hp at 6600 rpm for normal rating; however the transmission is restricted to a maximum of 1100 shp at 6600 rpm.

**7-7. Deleted.**

**7-8. Engine Air Screens.** The maximum speed at which the Engine Air Screens can be actuated is 100 knots.

**7-9. Rotor Limitations.** The normal operating range of the main rotor is 294 to 324 rpm and is marked on the dual tachometer as a green arc on face of the instrument. Autorotation main rotor speed shall not exceed 339 rpm. Main rotor speeds in excess of 339 rpm shall be recorded in DA form 2408.

**7-10. Airspeed Limitations.** The maximum permissible indicated forward speed is 190 knots. Sideward and rearward airspeeds should be limited to 30 knots which must be estimated because instruments required to provide these indications have been considered unnecessary.

**7-11. Canopy Hatch Limitations.** The canopy hatch shall not be opened above 45 knots.

**7-12. Prohibited Maneuvers.** In-flight maneuvers are restricted as follows:

a. No aerobatic maneuvers permitted.

b. Protracted rearward flight and downwind hovering are prohibited.

c. The speed for any and all maneuvers shall not exceed the speeds as stated in Airspeed Limitations.

d. Partial-power descents shall be accomplished at landing approach speed not less than shown on the Landing Power Off Chart, Chapter 14.

**7-13. Hovering Limitations.** Hovering performance limits for the helicopter are shown in Chapter 14. Your attention is called to the fact

that hovering in-ground-effect at altitudes from contact to 10 feet does not involve a time element.

**7-14. Center of Gravity Limitations.** The maximum center of gravity limitations are: Station 190.0 to station 201.3 (see figure 7-3).

**7-15. Height Velocity Diagram.** The height velocity diagram (see figure 7-4) is based on operating experience of the UH-1B.

**7-16. Towing Limitations.** Towing the helicopter on the ground handling wheels on unprepared surfaces at gross weight in excess of 9000 pounds will cause permanent set in the aft cross tube.

**7-17. "G" Loading.** General structural design "G" loadings are as follows:

a. Crash landing loads for items whose failure would cause a hazard to the occupants.

- (1) Forward 15.0 G Ultimate
- (2) Lateral (plus or minus) 5.0 G Ultimate
- (3) Vertical-down 15.0 G Ultimate

b. Transmission and pylon crash loading.

- (1) Forward 8.0 G Ultimate
- (2) Lateral (plus or minus) 8.0 G Ultimate
- (3) Vertical (Down) 8.0 G Ultimate

c. Flight and landing load factors at design gross weight.

- (1) Positive 3.5 G
- (2) Negative -0.5 G
- (3) Landing 4.5 G

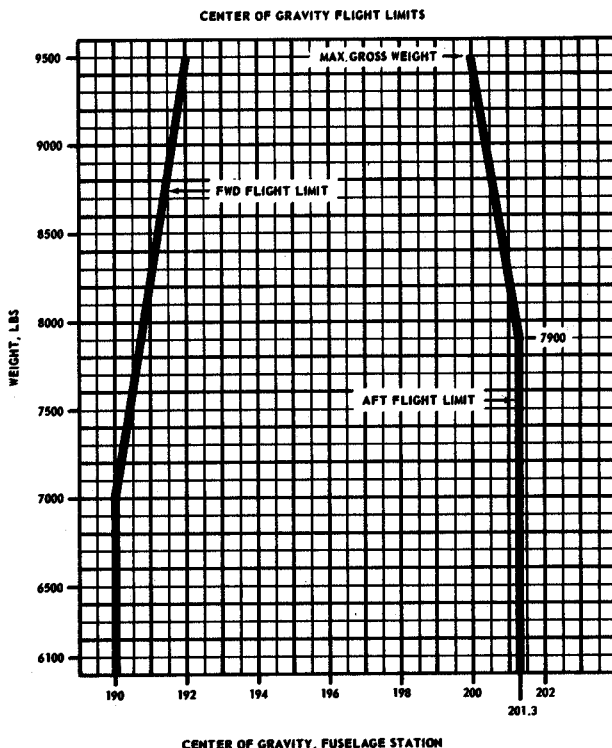

209900-27

Figure 7-3. Center of gravity limits

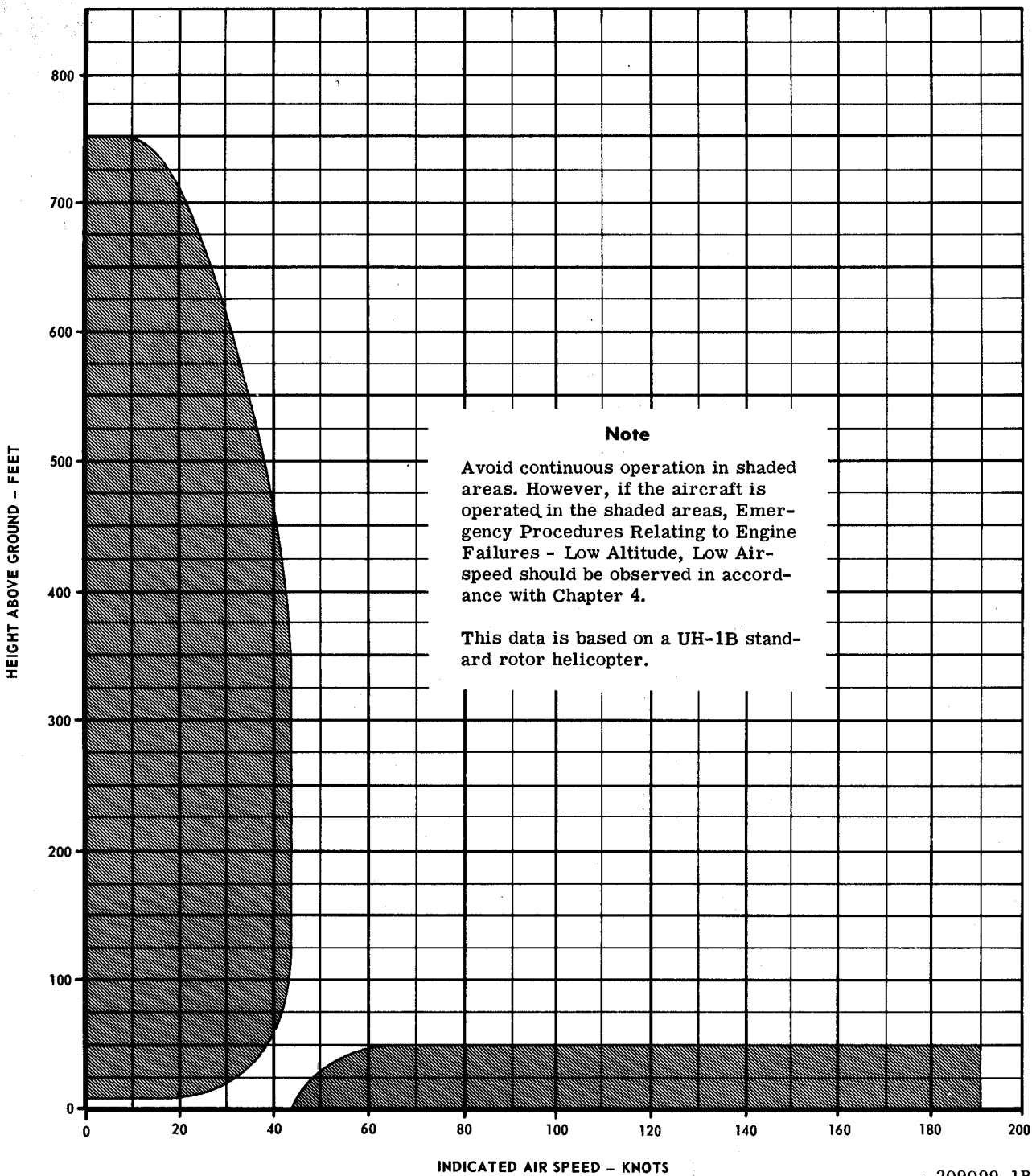

Figure 7-4. Height velocity diagram

d. Partial-power descents shall be accomplished at landing approach speed not less than shown on the Landing Power Off Chart, Chapter 14.

**7-13. Hovering Limitations.** Hovering performance limits for the helicopter are shown in Chapter 14. Your attention is called to the fact that hovering in-ground-effect at altitudes from contact to 10 feet does not involve a time element.

**7-14. Center of Gravity Limitations.** Center of gravity limitations are: Station 190.0 to station 202.0.

**7-15. Height Velocity Diagram.** The height velocity diagram (see figure 7-3) is based on operating experience of the UH-1B.

**7-16. Towing Limitations.** Towing the helicopter on the ground handling wheels on unprepared surfaces at gross weight in excess of 9000 pounds will cause permanent set in the aft cross tube.

**7-17. "G" Loading.** General structural design "G" loadings are as follows:

a. Crash landing loads for items whose failure would cause a hazard to the occupants.

- |                             |                 |
|-----------------------------|-----------------|
| (1) Forward                 | 15.0 G Ultimate |
| (2) Lateral (plus or minus) | 5.0 G Ultimate  |
| (3) Vertical-down           | 15.0 G Ultimate |

b. Transmission and pylon crash loading.

- |                             |                |
|-----------------------------|----------------|
| (1) Forward                 | 8.0 G Ultimate |
| (2) Lateral (plus or minus) | 8.0 G Ultimate |
| (3) Vertical (Down)         | 8.0 G Ultimate |

c. Flight and landing load factors at design gross weight.

- |              |        |
|--------------|--------|
| (1) Positive | 3.5 G  |
| (2) Negative | -0.5 G |
| (3) Landing  | 4.5 G  |

## CHAPTER 8

### FLIGHT CHARACTERISTICS

#### Section I — Scope

**8-1. Purpose.** The purpose of this Chapter is to describe the flight characteristics of the aircraft. Emphasis has been placed on the advantageous as well as the dangerous flight characteristics.

**8-2.** The information herein is based on operations at maximum gross weight.

#### Section II — General Flight Characteristics

**8-3. Operating Characteristics.** The flight characteristics of this helicopter in general are similar to other single rotor helicopters. The particular noticeable difference is the additional stability that is evident during take-off, hovering and all flight speeds. This stable condition is the result of the Stability Augmentation System (SAS). The control system, with hydraulic servo assist, provides the pilot with a light force required for control movements; however, control feeling is induced into the cyclic stick and tail rotor control pedals by means of a force trim system. To increase helicopter forward speed, simultaneously apply forward control stick and increase main rotor pitch; power is automatically adjusted to maintain constant rpm. Constant altitude is maintained throughout the entire range of forward flight speeds by fore and aft use of the cyclic control stick in coordination with power and main rotor pitch application. Direction and heading are controlled by the application of lateral cyclic control and the appropriate tail rotor control pedal.

**8-4. Blade Stall.** Blade stall is caused by a high angle of attack on the retreating blade and starts at the inboard section and progresses outboard with increased airspeed. However, this condition will not cause adverse handling qualities when the helicopter is operated within the limits imposed in the preceding Chapters of this manual. Blade stall is the result of numerous contributing factors such as gross

weight, rotor rpm, airspeed, acceleration and altitude. The condition is most likely to occur at the high airspeeds and low operating rpm; it also follows that the condition will occur sooner with higher values of altitude and gross weight. One of the more important features of the two-bladed, semi-rigid system is its warning to the pilot of impending blade stall. Prior to progressing fully into the stall region the pilot will feel a marked increase in airframe vibration. Consequently, corrective action can be taken before the stall condition becomes severe.

#### Note

When the rotor stall progresses into a severe state, feedback may occur primarily in the cyclic control.

**8-5. Blade Stall — Corrective Action.** When blade stall is evident the condition may be eliminated by accomplishing one or a combination of the following corrective actions.

- a. Reduce collective.
- b. Reduce airspeed.
- c. Increase operating rpm.
- d. Descend to lower altitude.
- e. Decrease the severity of the maneuver.



**8-6. Rotor Capabilities.** The helicopters are capable of delivering a maximum thrust commensurate with rotor-transmission engine limitations and the density of the atmosphere in which they are operating. Maximum thrust can be utilized to obtain maximum airspeed, optimum rate of climb, or, at some reduced airspeed, the maximum maneuver potential. The pilot may employ the capabilities of the helicopter within maximum limitations and in accordance with the environment under which he is operating.

**8-7.** During maneuvering turns, a greater "G" load, which varies with the angle of bank, is exerted on the rotor. In a stabilized angle of bank a constant load intensity will result. As the bank attitude is increased, the weight imposed on the rotor will increase. For instance, a 30 degree bank will produce 1.15 "G's", a 45 degree bank 1.4 "G's", a 60 degree bank 2.0 "G's". Based on the fact that the rotor experiences a 1.0 "G" load in level flight, it can readily be seen that this factor increases 100% in a stabilized bank of 60 degrees. The observed airspeed should be reduced during maneuvers to prevent excessive "G" loads.

**8-8.** A descending turn or autorotational turn at a given angle of bank and stabilized rate of descent imposes the same "G" load on the rotor. Hence, if the turn is too abrupt (tight) and rotor limits are exceeded, further application of controls will not check the rate of descent if the turn is continued. In order to alleviate this condition the pilot must roll out of the turn

to reduce the rotor load and provide control response, and reduce rate of descent. The permissible bank angles vs altitudes and gross weights will affect the turning radius of the helicopter. A light gross weight helicopter turns within an area comparable in size to that contained within the boundaries of a football field. The same helicopter at normal gross weight and at a density altitude of 12,000 feet will require a much larger area to accomplish the same turn.

**8-9. Maneuvering Flight.** Action and response of the controls during maneuvering flight is normal at all times when the helicopter is operated within the limitations set forth in this manual.

**8-10. Hovering Capability.** Hovering capability is affected by in-ground-effect (IGE), out-of-ground effect (OGE), outside air temperature (OAT), density and pressure altitude, wind speed, engine torque (power available), and gross weight of the helicopter. Hovering IGE performance is better than OGE because during IGE the rotor sets up a current flow between the helicopter and the ground, providing a cushion of air to partially support the helicopter weight. Temperature variations affect engine and rotor performance. Hovering with heavier gross weights or at higher altitudes is possible with lower temperatures and higher wind velocities. Lower temperatures increase engine efficiency and wind represents airspeed; therefore, either condition or both will increase hovering performance due to the ability of the main rotor to provide more lift.

### Section III — Control Characteristics

**8-11. Level Flight Characteristics.** The level flight characteristics of this helicopter are normal throughout the operating limits range. All control response is immediate and gives positive results.

**8-12. Autorotation Characteristics.** Due to the wide speed range capability of the AH-1G, it is felt that some discussion of the POWER OFF characteristics of the rotor system is essential.

**8-13. Main Rotor.** The following steps explain the necessity of maintaining the rotor rpm in its normal range (295 to 339).

a. Normal rotor speed. The normal rotor speed assures the pilot that he will retain adequate Control Effectiveness. Low rpm (under-speed) causes a proportional loss of response to control inputs. High rpm (overspeed) can cause structural damage to the rotor system.

b. Rotor flapping. The angle between the tip path plane and the mast increases at low rpm. By maintaining rotor rpm in the normal range, the pilot assures safe clearance between the rotor and the tail boom.

c. Rotor inertia. Rotor inertia is a characteristic which tends to prolong the effectiveness of collective control in the autorotation landing. This effectiveness decreases with rpm. Normal rotor rpm assures the pilot that he will have normal inertia and normal collective control response with which to arrest the sink rate in the autorotation landing.

**8-14. Rotor RPM.** The following steps list the factors which affect power-off rotor rpm.

a. Airspeed. In autorotation, rotor rpm varies with airspeed. For steady state, stabilized conditions, the speed range for maximum rotor rpm is 60 to 80 knots (see figure 8-1). The rpm decreases, stabilized conditions, at speeds above or below the 60 to 80 knot range. When changing airspeed the transient effect of cyclic control application is dominant.

(1) Low speed. From a stabilized 30 knot autorotation condition, if a positive forward cyclic control input is made to increase speed, the rpm will initially decrease and then increase when the helicopter is stabilized at the higher speed.

(2) High speed. From a stabilized 130 knot autorotation condition, if a positive aft cyclic control input is made to reduce speed, the rpm will initially increase and then decrease when the helicopter is stabilized at the lower speed.

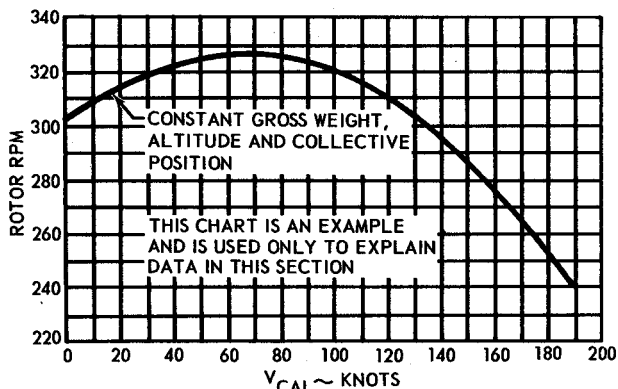

Figure 8-1. Main rotor rpm versus airspeed

209900-22

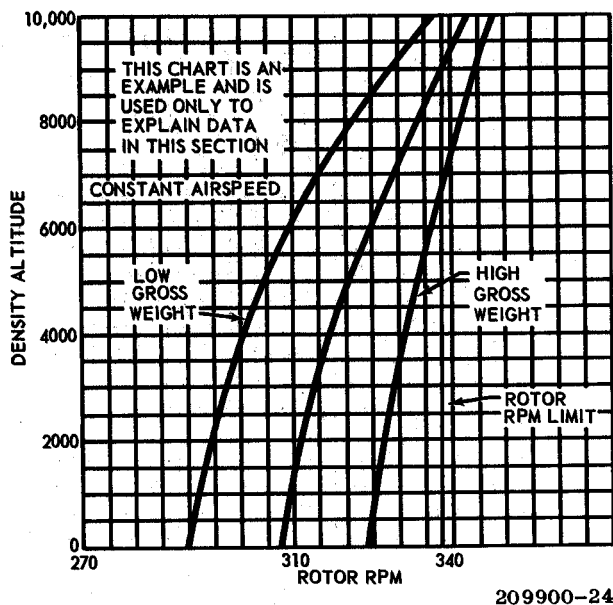

Figure 8-2. Main rotor rpm versus gross weight and altitude

209900-24

b. Gross Weight. The power-off rotor rpm varies significantly with gross weight. A low gross weight will produce a low rotor rpm. A high gross weight will produce a high rotor rpm. With the collective system correctly rigged to a minimum blade angle (full down collective stick) of approximately 8.5 degrees the pilot must manually control rpm with the collective stick in order to prevent overspeeding of the rotor when at high gross weight and 70 knots airspeed.

**Note**

The minimum blade angle rigging is dictated by the minimum autorotation rpm requirement (295) when at light gross weight and low altitude (see figure 8-2).

c. Density Altitude. The power-off rotor rpm varies with altitude: low altitude—low rpm; high altitude—high rpm (see figure 8-3). For the same flight conditions as in step b, the pilot will find that the higher the altitude—the higher the collective stick position required to prevent overspeeding of the rotor.

d. Cyclic Flare. Aft cyclic control application (nose up pitching) produces an increase in rotor rpm proportional to the flare and entry speed.

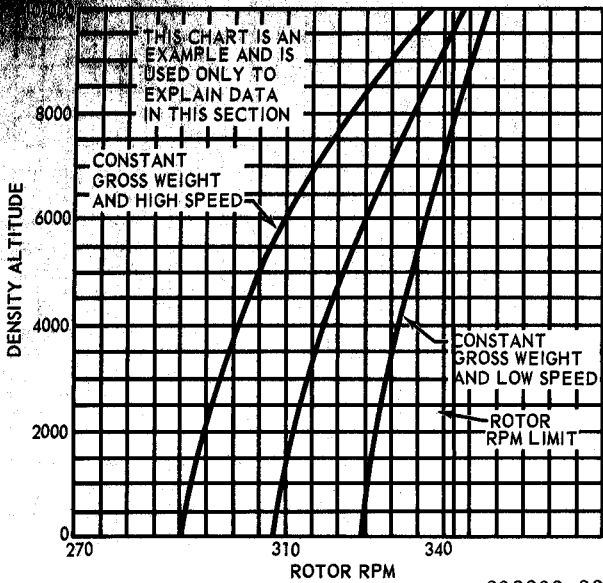

Figure 8-3. Main rotor rpm versus altitude and airspeed

The higher the speed — the greater the flare effectiveness. From a high speed entry condition, a steep flare can produce an overspeed unless limited by collective pitch control.

8-15. *Pilot Technique.* It can be readily seen from the information, in paragraphs 8-13, and 8-14, that pilot technique must vary in accordance with the actual conditions of airspeed, altitude and gross weight at the time of engine failure.

8-16. Deleted.

8-17. Deleted.

8-18. Deleted.

8-19. Deleted.

8-20. Deleted.

Page 8-5/8-6 Deleted.

Figure 8-4. Deleted

**8-17.** From a condition of medium speed range (approximately 40-120 knots) and altitudes above 100 feet—cyclic flare and collective should be coordinated as required to maintain rpm and set up a recommended approach speed of 60-70 knots, followed by a flare type landing.

**8-18.** The 60-70 knot speed range is recommended for approach because it is the approximate speed for minimum rate of descent (see figure 8-4) and also because it represents a good compromise between ground speed and flare effectiveness.

**8-19.** From the higher speed range, 120-190 knots—first—initiate cyclic flare. The flare and partial collective reduction should be co-

ordinated as required to maintain rpm — but the pilot also has the capability of maintaining or in some cases increasing his altitude — depending on speed and the steepness of the flare utilized. Speed should be reduced to 60-70 knots for the approach and followed by a flare type landing.

**8-20.** The flare type landing is recommended, when conditions permit, because of three significant advantages derived from the flare.

- a. Reduction of rate of descent.
- b. Reduction of ground speed.
- c. Increased rotor rpm.

## CHAPTER 9

### SYSTEM OPERATION

#### Section I — Scope

**9-1. Purpose.** This Chapter provides additional material (to that already covered in other Chapters) regarding the operation of various aircraft systems.

**9-2.** The operation of new or complex systems are covered herein.

#### Section II — Systems Operation

**9-3. Freewheeling Unit.** The freewheeling unit, which is an integral part of the transmission input quill, provides a positive disconnect from the engine in case of a power failure and allows the main rotor and tail rotor to rotate in order to accomplish safe autorotation landings.

**9-4. Stability Augmentation System (SAS).** The (SAS) is a three axis stability and control augmentation system. It is integrated into the fore and aft, lateral and directional flight controls to improve the stability and the handling qualities of the helicopter. The system consists of the electro-hydraulic servo actuators, the control motion transducers, the sensor/amplifier unit and the control panel (see figure 9-1). The sensor/amplifier unit produces the electrical inputs to the servo actuators. The servo actuators are installed as series extensible links in the appropriate flight controls and provide the compensating control motions to augment the stability and control of the helicopter. The operation of the servo actuators is not felt in the pilot's controls. The servo actuators are limited to 25 percent authority and center and lock in case of electrical and/or hydraulic failure.

**9-5.** The SAS system provides a highly damped airframe for external disturbances yet maintains high quality control/response characteristics for pilot inputs. The rate gyros (located in the sensor/amplifier unit) provide the electrical signals for airframe damping against external disturbances. The control motion transducers provide a compensating electrical signal to prevent the system from opposing the pilot during

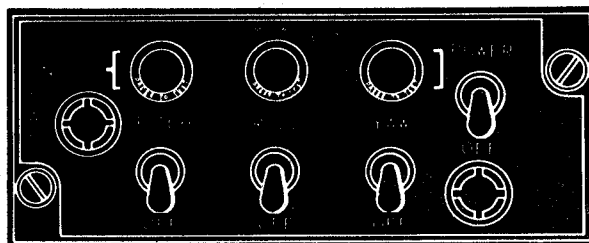

570074-1

Figure 9-1. SAS control panel

maneuvers and to augment the control/response characteristics.

**9-6. Engine Air.** The engine is equipped with an automatic ENGINE AIR system, made up of a detection system, inlet screen actuator and bleed air valve system. The detector, negative pressure switch, located in the induction area, senses an obstruction in the engine's air induction system and closes the electrical contact points in the pressure switch. The closing of the contacts illuminates the ENGINE AIR caution light. When the ENGINE AIR caution panel is illuminated the ENGINE AIR switch on the engine control panel (see figure 2-7) shall be moved to the DE-ICE or SCRNBYP (screen bypass) position. The switch shall not be actuated with an indicated airspeed in excess of 100 knots. When the ENGINE AIR switch is in the DE-ICE position the intake screen is actuated open and the bleed air anti-ice valve is opened. The bleed air is collected in a manifold, passes through the hot air valve and enters the port on top of the engine inlet housing. From

this point the air is then circulated through five of the six hollow inlet housing support struts to prevent ice formation in the inlet housing area. The air also flows into an annulus in the rear of the inlet housing to prevent ice formation on the inlet guide vanes. Hot scavenge oil, draining through the lower strut into the accessory drive gear box, prevents ice formation in the bottom of the inlet housing area. The detector system and actuator are powered by the 28 volt dc essential bus. When the ENGINE AIR switch is in the SCR N BYP position the induction screens are actuated open and the anti-icing system is non-functioning.

**Note**

The positioning of the ENGINE AIR switch to DE-ICE, SCR N BYP or SCREEN position is dictated by the illumination of the caution panel segment ENGINE AIR, climatic conditions and environmental conditions. The normal position for the switch is in the SCREEN position.

**9-7. Droop Compensator.** Droop is defined as the speed change in engine rpm (nII) as power is increased from a no-load condition. It is an inherent characteristic designed into the governor system. Without this characteristic instability would develop as engine output power is increased, resulting in nI speed over-shooting or hunting the value necessary to satisfy the new power condition. Design droop of the engine governor system is as much as 300 to 400 rpm (flat pitch to full-power). If nII power were allowed to droop, other than momentarily, the reduction in rotor speed could become critical; therefore, a droop compensator is installed on the governor control to raise nII speed as power is increased, to the rpm value selected by the pilot. The compensator is a direct mechanical linkage between the collective control lever and the speed selector lever on the nII governor. Properly rigged, the droop compensator will hold nII rpm to plus or minus 50 rpm from flat pitch to climb out power.

**Note**

An improperly rigged droop compensator can result in the engine not developing rated power. Always check droop compensator rigging prior to checking full power.

**Caution**

A shear pin is incorporated in the droop compensator linkage to permit collective control movement in the event of a bind occurring in the droop compensator linkage. When the pin is sheared, the droop compensator is inoperative and care must be taken to maneuver within power adjustment capabilities of the governor. Sheared pin shall be replaced before new flight.

**9-8. Dual Hydraulic System.** Hydraulic power is supplied by a dual hydraulic system, (No. 1 and No. 2) which minimizes the force required by the pilot to move the cyclic, collective and directional control systems. Basically, the two systems are identical excluding the portion of system No. 1, which supplies pressure to the directional control system and the portion of system No. 2, which supplies pressure to the armament system. The systems contain the following major components peculiar to both systems: reservoirs, pumps (transmission driven), modules and three dual actuating cylinders (two for cyclic and one for collective controls) with dual servo valves. Each system module is comprised of the following units; pressure line filter, pressure line filter indicator, pressure switch, system ON-OFF solenoid valve, system relief valve, return line filter, return line filter indicator and two ground test connections. This dual system with pressure going into dual actuators offers the pilot a greater safety factor.

**9-9. System No. 1.** Hydraulic fluid from the reservoir passes through the constant pressure, variable delivery seven piston pump, delivering fluid at 1500 psi to the No. 1 module system. This module has on the pressure side its filter element and magnetic indicator, a solenoid valve which when de-energized the system is "ON" and energized the system is "OFF". The module also incorporates, a pressure switch which warns the pilot of "Hydraulic Low Pressure" and on the hydraulic fluid return a filter element with a magnetic indicator. On the module two quick disconnect couplings for the auxiliary hydraulic system are also incorporated. Between the pump and the reservoir there is a bypass line having a filter element. From the module the fluid flows to the three servo actuating valves which are dual acting, directing the pressurized fluid to the dual servo actuating cylinders at a minimum 1500 psi. The No. 1 system

also supplies pressure to the directional control system, directional control (YAW) SAS system and charges the emergency hydraulic system.

**9-10. System No. 2.** Hydraulic fluid from the reservoir passes through the constant pressure, variable delivery seven piston pump, delivering fluid at 1500 psi to the No. 2 module. This module has on the pressure side its filter element and magnetic indicator, a solenoid valve which is actuated by the pilot so that when de-energized the system is "ON" and energized the system is "OFF". The module also incorporates a pressure switch which warns the pilot of "Hydraulic Low Pressure" and on the hydraulic fluid return a filter element with a magnetic indicator. On the module two quick disconnect couplings for the auxiliary hydraulic system are also incorporated. Between the pump and the reservoir there is a bypass line having a filter element. From the module the fluid flows to the three servo actuating valves which are dual acting, directing the pressurized fluid to the dual servo actuating cylinders at a minimum 1500 psi. The No. 2 system also supplies the armament system and the SAS system of the lateral (ROLL) and fore and aft (PITCH) cyclic system. System No. 2 incorporates an automatic priority valve so the cyclic and collective flight controls have the priority of the hydraulic system pressure and flow over the armament.

**9-11. Emergency Hydraulic Power (Accumulator System).** The emergency hydraulic system provides irreversibility in the cyclic control system and limited duration emergency power for the collective system. The system has a series of lock-out valves, check valves, spring and air charged accumulator and an electrical solenoid valve. The emergency system is fluid charged by hydraulic system No. 1. When both systems (No. 1 and No. 2) become inoperative, the up-stream lock-out valve and spring loaded accumulator in conjunction with the check valve, located at the inlet port of each cyclic cylinder provide partial pressurization of each cyclic cylinder. Up stream of the collective hydraulic cylinder, a pressurized lock-out valve, air charged accumulator, pilot controlled electric solenoid valve and two check valves are provided and so arranged to provide oil stored at 1500 psi to the collective cylinder only. Sufficient pressure and volume is available to allow approximately four full strokes (a stroke is maximum movement in one direction) of the collective control. During normal operations the

accumulator is charged through the check valve located in parallel to the solenoid valve in the accumulator circuit. An electrical switch is provided on the instrument panel to allow the pilot to close (energize) the solenoid valve which conserves the stored energy in the collective system to permit adequate collective control power for landing.

**9-12. Hydraulic System Operation.** After the engine has started, the following should be observed.

a. Place and leave EMER COLL HYD switch in OFF position.

b. HYDraulic TEST switch — Push and hold to SYSTEM 1.

c. Cyclic and Collective — Check freedom of movement; note HYD PRESS No. 2 warning light on caution panel. Pedal movement should be free.

d. HYDraulic TEST switch — Push and hold to position SYSTEM 2.

e. Cyclic and Collective — Check freedom of movement; note HYD PRESS No. 1 system warning light on caution panel. Pedal movement should be stiff.

f. HYDraulic TEST switch — RELEASE SWITCH.

g. Hydraulic indicator light for both systems should be out.

**9-13. Electrical System — Armament Sub-system.**

**Note**

This discussion assumes that the aircraft INVERTER switch and the armament circuit breakers are in the ON position.

**9-14. Master Armed Bus.** The master armed bus (figure 9-2) is energized by placing the MASTER ARMED switch, located in the pilot's station, in the ON position. This applies 28 volt dc to various relays and switches located in the control and firing circuits for standby use. The PILOT OVERRIDE switch, when placed in the fwd (ON) position (for emergency use only) ■

will energize the same circuits as the MASTER ARMED switch and gives control of the system to the gunner.

**9-15. Control Circuits.** The gunner cannot position the turret unless the action switches on the sight hand grips are depressed. A 28 volt dc signal is applied to the action switches when the pilot's CONTROL SELECTOR switch is placed in the PILOT or GUNNER position. A signal is also applied to the action switches when the TURRET POWER switch on the gunner's control panel is placed in the fwd (ON) position.

Depressing the action switches energizes the relay and the gunner action relay. A signal is induced from the rotor of the azimuth and elevation resolvers in the sighting station through the energized gunner action relay to the azimuth and elevation demodulator amplifiers. The signal is amplified and sent to the azimuth and elevation servo valves to drive the turret in both axis. When the position signals from the turret resolvers are the same as the position from the sighting station resolvers, the turret and sight are in coincidence and turret movement stops until the sight is repositioned.

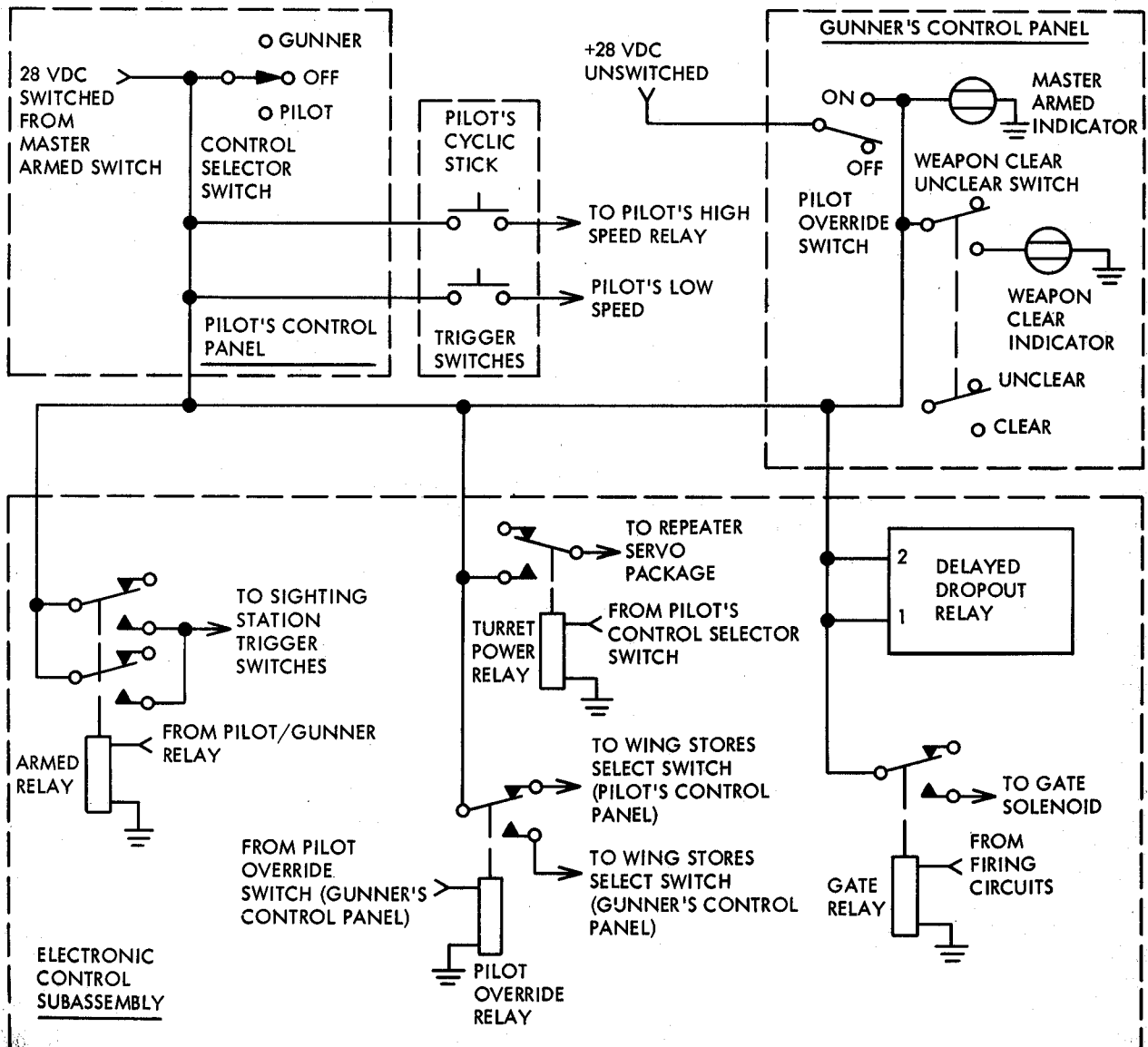

Figure 9-2. Master armed bus schematic



will energize the same circuits as the MASTER ARMED switch and gives control of the system to the gunner.

**9-15. Control Circuits.** The gunner cannot position the turret unless the action switches on the sight hand grips are depressed. A 28 volt dc signal is applied to the action switches when the pilot's CONTROL SELECTOR switch is placed in the PILOT or GUNNER position. A signal is also applied to the action switches when the TURRET POWER switch on the gunner's control panel is placed in the fwd (ON) position.

Depressing the action switches energizes the relay and the gunner action relay. A signal is induced from the rotor of the azimuth and elevation resolvers in the sighting station through the energized gunner action relay to the azimuth and elevation demodulator amplifiers. The signal is amplified and sent to the azimuth and elevation servo valves to drive the turret in both axis. When the position signals from the turret resolvers are the same as the position from the sighting station resolvers, the turret and sight are in coincidence and turret movement stops until the sight is repositioned.

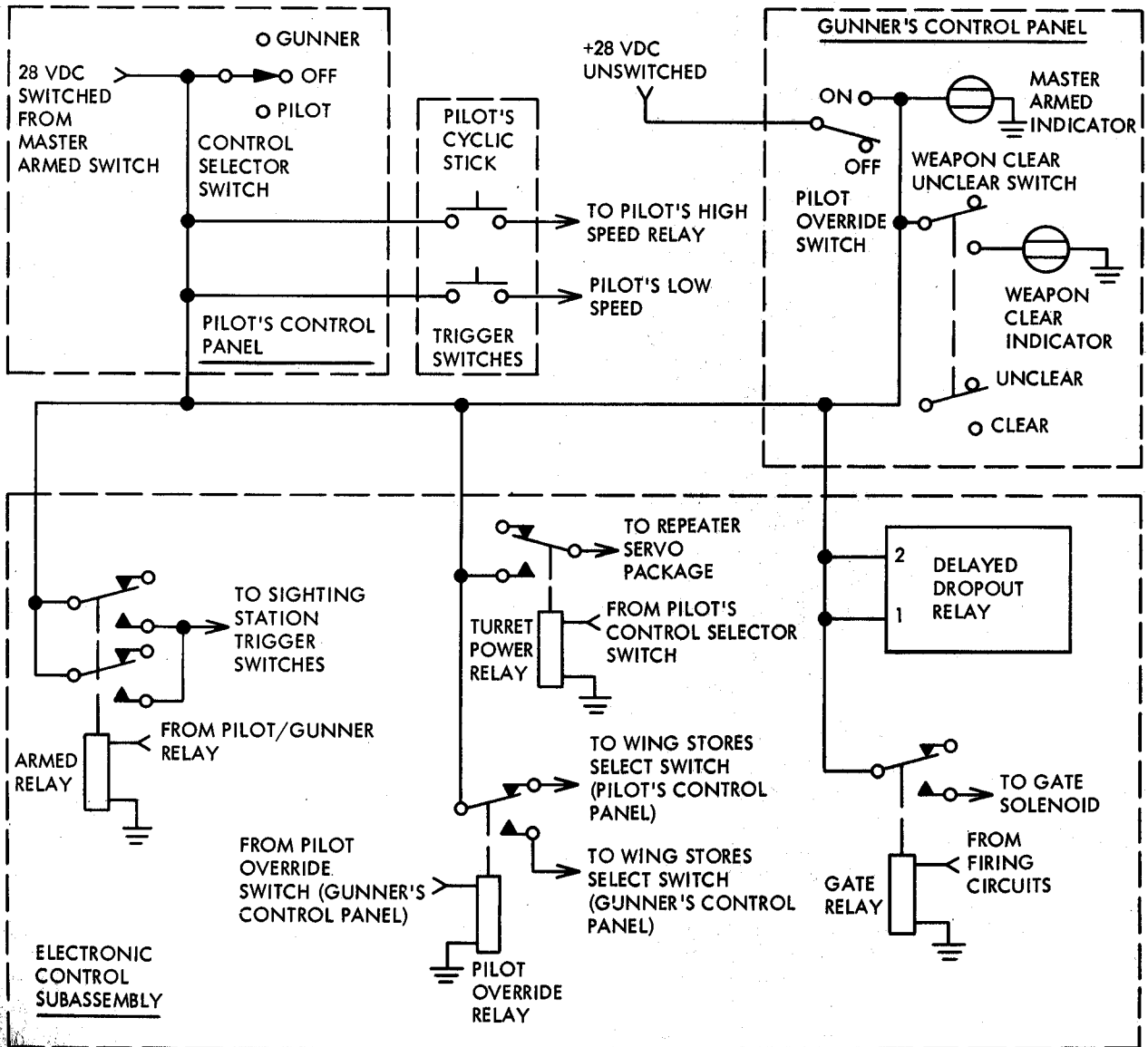

Figure 9-2. Master armed bus schematic

**9-16. Firing Circuit.** Placing the pilot's CONTROL SELECTOR switch in the GUNNER position energizes the pilot/gunner relay and stow lock relay, and applies 28 volt dc to the gunner's action switches. The gunner cannot fire the weapon unless one of the action switches on the sight hand grips is depressed. When the action switch is depressed, the signal passes through the previously energized pilot/gunner relay to energize the armed relay; 28 volt dc from the master armed bus is then applied to the gunner's trigger switches. The gun is fired at the low firing rate when one of the low rate firing triggers is depressed. A 28 volt dc signal is then passed through the previously energized pilot/gunner relay, through the closed contacts of the last round switch to the azimuth coincidence relay. If the sight and turret are in coincidence, the azimuth and elevation relays are energized and the signal is passed through the elevation limit interlock to energize the gate relay, the delayed dropout relay and the delayed pull-in relay. A 28 volt dc signal from the master armed bus is then passed through the delayed dropout relay and gate relay to energize the gate solenoid and No. 1 firing solenoid. Momentarily after the delayed dropout relay is energized, the delayed pull-in relay activates and applies a signal to No. 2 firing solenoid. The No. 2 solenoid reduced the oil flow to the gun drive motor, thereby maintaining the gun speed at the low firing rate of 1300 rounds per minute. When either of the high rate firing triggers is depressed, the signal to No. 2 firing solenoid is removed and maximum oil flow is applied to drive the gun at the high firing rate of 4000 rounds per minute.

**9-17.** Placing the pilot's TURRET CONTROL switch in the PILOT position applies 28 volt dc from the master armed switch to the pilot's trigger switch and energizes the stow lock relay. When the pilot depresses the low rate firing trigger, one signal is passed through the firing circuit to energize No. 1 firing solenoid, and another signal is applied through the pilot's high speed relay to No. 2 firing solenoid, causing the gun to fire at the low rate of speed. When the pilot depresses the high rate firing trigger, the pilot's high speed relay energizes, switching off the signal to the No. 2 firing solenoid and causing the gun to fire at high rate of speed.

**9-18. Hydraulic System.** Hydraulic power is supplied to the hydraulic system (figure 9-3) of the assembly from the hydraulic system of

the aircraft, at a flow of 5.8 GPM and a pressure of 1500 PSI. This hydraulic pressure is used to position the azimuth and elevation gimbals and operate the gun.

**9-19.** The turret assembly hydraulic system is connected to the aircraft hydraulic system by two quick-disconnect couplings. Oil flows through a 10-micron filter to the swivel joint located in the top center portion of the turret assembly. This joint supplies oil to the azimuth drive motor, elevation control actuator and gun drive motor. The lower movable section of the joint contains two "T" fittings. Each "T" contains two line connections to route the pressure and return lines to various hydraulic components of the turret assembly.

**9-20. Azimuth Drive Motor.** Hydraulic flow to drive the azimuth drive motor is controlled by an azimuth servo valve. When the azimuth servo valve is energized, oil flows through the servo valve to the azimuth drive motor. The direction and speed of the azimuth drive motor is dependent upon the polarity and magnitude of the electrical signal applied to the servo valve. The azimuth drive motor drives a 10:1 reduction gear box, which is geared to the azimuth turret ring gear.

**9-21. Elevation Control Actuator.** Hydraulic flow to operate the elevation control actuator is controlled by the elevation servo valve. When the elevation servo valve is energized, oil flows through the servo valve and out port C1 or C2 to the actuator. The port from which the oil will flow is dependent upon the polarity and magnitude of the electrical signal applied to the servo valve. Applied pressure from port C1 to the elevation position control actuator will extend the cylinder and depress the gun. Applied pressure from port C2 on the elevation position control actuator will retract the cylinder and elevate the gun. Two air bleed valves are installed on the elevation position control actuator to bleed air from the turret system.

**9-22. Gun Drive Motor.** Hydraulic flow to operate the gun drive motor is controlled by the dual flow rate solenoid control valve. When the dual flow rate solenoid control valve is energized, hydraulic oil flows through the solenoid valve to the gun drive motor. The gun drive motor drives a 10:1 reduction gear box which drives the gun.

**9-23.** When the operator selects the low rate of fire, the No. 1 solenoid is energized allowing

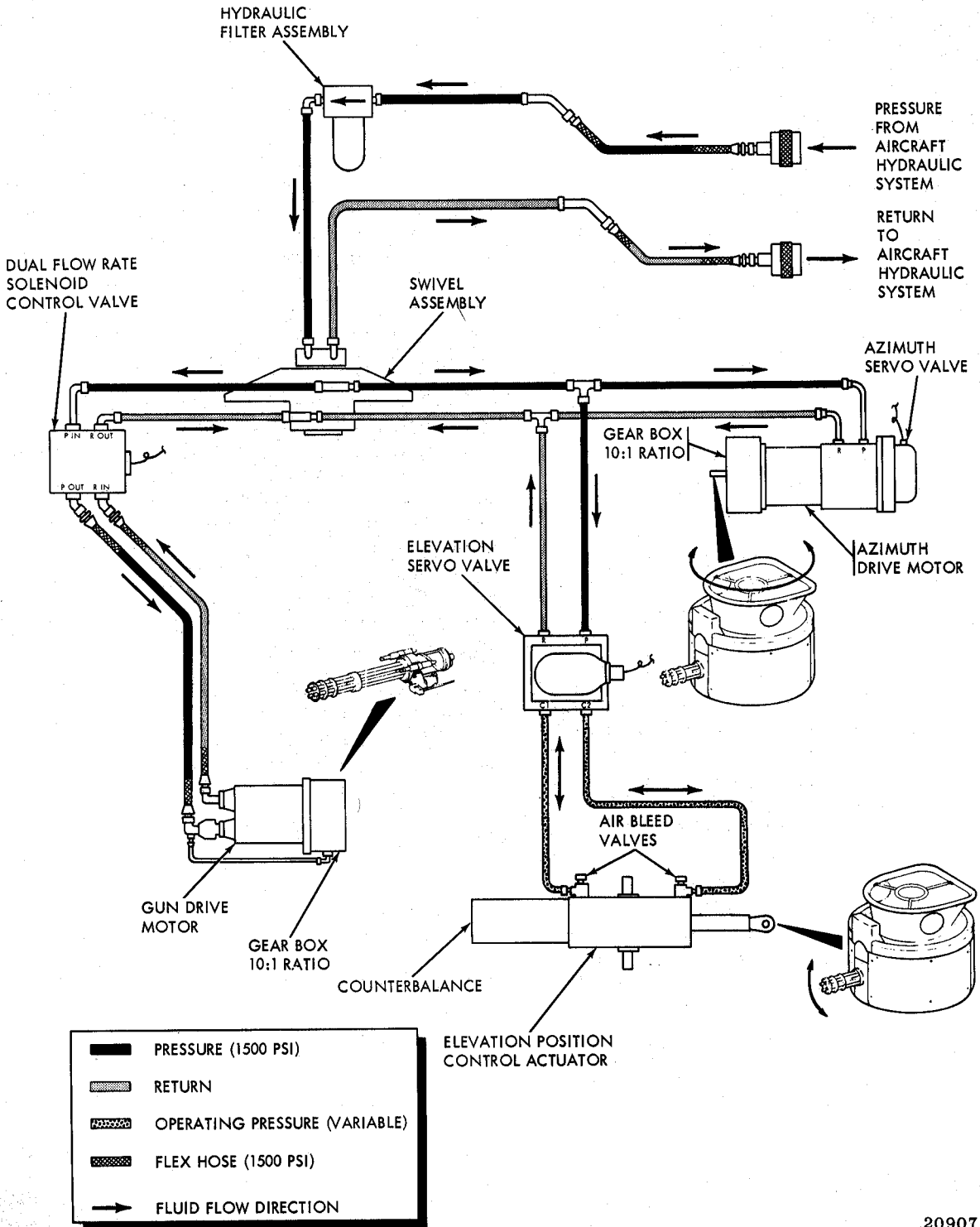

209071-11

Figure 9-3. Armament hydraulic system schematic

## CHAPTER 10

### WEATHER OPERATIONS

#### Section I — Scope

**0-1. Scope of Weather Operation Instructions.** The purpose of this Chapter is to provide information relative to operation under conditions of instrument flight and approach. This includes ground control approach, turbulent air flight, extreme cold and hot weather operations, night flying, etc. Description of the equipment is not covered, since that information is appropriately covered in other Chapters.

**10-2.** Except for some repetition which is necessary for continuity of thought, the flight procedures in this Chapter contain only the procedures that differ from, or are in addition to normal procedures covered in Chapter 3. The checklists presented in Chapter 3, and the operating procedures or the navigation equipment in Chapter 5, are to be used in conjunction with the information presented in this Chapter.

#### Section II — Instrument Flight Procedures

**10-3. Introduction.** The helicopter has been provided with the necessary instruments and navigation radio equipment to accomplish missions from prepared or unprepared take-off or landing areas, under instrument operations including light icing conditions, day or night flying and to navigate by dead reckoning or by use of radio aids to navigation.

**10-4.** Instrument flights should be carefully planned, keeping in mind that icing conditions, turbulent air and thunderstorms will greatly affect the flight. Except for some repetition which is necessary for continuity of thought, the instrument flight procedures contain only the procedures that differ or are in addition to normal procedures covered in other sections. Basic maneuvers for rotor wing aircraft are contained in TM 1-215.

**10-5. Preflight And Ground Checks.** Perform the normal preflight inspections, including the night flight checks, as outlined in the normal operating instructions in Chapter 3. Particular attention should be paid toward proper operation of flight instruments, navigation equipment, external and internal lighting, defrosters, pitot heat, generator, inverters and engine ice protection.

**Note**

Ground check of the engine ice protection system is accomplished by pulling

the anti-ice (engine) circuit breaker and determining a rise in the engine EGT.

If possible, set and check altimeters for error before engine start. After engine start, note the decrease in altimeter reading induced by rotor downwash effect. This decrease will be approximately 20 feet with a collective pitch setting of 15 pounds torque.

**10-6. Instrument Take-Off.** The attitude indicator, heading indicator and torque meter are primary for instrument take-offs. By use of these instruments, along with the following procedures, ITO's are easily accomplished.

**10-7.** After positioning the aircraft on a level or near level surface and into the wind, set aircraft heading selector marker to top of the heading indicator and adjust the horizon bar of the attitude indicator so that the miniature airplane will appear approximately two bar widths above the horizon bar.

**10-8.** With a steady, smooth motion apply collective pitch until five pounds of torque more than that required for hovering is obtained. As the aircraft leaves the ground, position the cyclic so that the miniature airplane will appear one to two bar widths below the horizon

## CHAPTER 10

### WEATHER OPERATIONS

#### Section I — Scope

**10-1. Scope of Weather Operation Instructions.** The purpose of this Chapter is to provide information relative to operation under conditions of instrument flight and approach. This includes ground control approach, turbulent air flight, extreme cold and hot weather operations, night flying, etc. Description of the equipment is not covered, since that information is appropriately covered in other Chapters.

**10-2.** Except for some repetition which is necessary for continuity of thought, the flight procedures in this Chapter contain only the procedures that differ from, or are in addition to normal procedures covered in Chapter 3. The checklists presented in Chapter 3, and the operating procedures or the navigation equipment in Chapter 5, are to be used in conjunction with the information presented in this Chapter.

#### Section II — Instrument Flight Procedures

**10-3. Introduction.** The helicopter has been provided with the necessary instruments and navigation radio equipment to accomplish missions from prepared or unprepared take-off or landing areas, under instrument operations including light icing conditions, day or night flying and to navigate by dead reckoning or by use of radio aids to navigation.

the anti-ice (engine) circuit breaker and determining a rise in the engine EGT.

If possible, set and check altimeters for error before engine start. After engine start, note the decrease in altimeter reading induced by rotor downwash effect. This decrease will be approximately 20 feet with a collective pitch setting of 15 pounds torque.

**10-4.** Instrument flights should be carefully planned, keeping in mind that icing conditions, turbulent air and thunderstorms will greatly affect the flight. Except for some repetition which is necessary for continuity of thought, the instrument flight procedures contain only the procedures that differ or are in addition to normal procedures covered in other sections. Basic maneuvers for rotor wing aircraft are contained in TM 1-215.

**10-6. Instrument Take-Off.** The attitude indicator, heading indicator and torque meter are primary for instrument take-offs. By use of these instruments, along with the following procedures, ITO's are easily accomplished.

**10-5. Preflight And Ground Checks.** Perform the normal preflight inspections, including the night flight checks, as outlined in the normal operating instructions in Chapter 3. Particular attention should be paid toward proper operation of flight instruments, navigation equipment, external and internal lighting, defrosters, pitot heat, generator, inverters and engine ice protection.

**10-7.** After positioning the aircraft on a level or near level surface and into the wind, set aircraft heading selector marker to top of the heading indicator and adjust the horizon bar of the attitude indicator so that the miniature airplane will appear approximately two bar widths above the horizon bar.

**Note**  
Ground check of the engine ice protection system is accomplished by pulling

**10-8.** With a steady, smooth motion apply collective pitch until five pounds of torque more than that required for hovering is obtained. As the aircraft leaves the ground, position the cyclic so that the miniature airplane will appear one to two bar widths below the horizon

bar. Maintain directional control (heading) until airspeed increases, generally (30 to 40 knots) then transition to coordinate flight.

**10-9.** The take-off (miniature airplane one to two bars below horizon) and power setting (five psi plus hovering power) is to be maintained until the airspeed approaches the desired climbing airspeed (70 knots IAS). As the airspeed reaches 70 knots the pitch attitude is adjusted to the climbing attitude (miniature aircraft on the horizon bar). As climbing airspeed and attitude are attained, the power (collective pitch) should be adjusted to result in a 500 fpm rate of climb (approximately 20 pounds of torque). Higher rates of climb may be used for extended climbs.

#### **Warning**

The airspeed and vertical speed indicators and altimeter are unreliable below 25 knots IAS because of rotor downwash effect on the pitot static system. During take-off, do not rely on these instruments until the airspeed indicator reads at least 25 knots IAS. The time required to reach this speed will be approximately seven seconds.

**10-10. Instrument Climb.** These helicopters handle well in climbs and climbing turns. The recommended climb is 500 fpm at 70 knots IAS. No change should be made in the collective pitch setting unless the airspeed and vertical speed vary over plus or minus five knots IAS and plus or minus 100 fpm. Turns should be made utilizing the attitude indicator to obtain the recommended 15 degree angle of bank which approximates a standard rate turn of three degrees per second. Using approximately 20 pounds of torque with the cyclic pitch set so that the miniature aircraft on the attitude indicator is level with the horizon bar should give the recommended climb airspeed and vertical speed. Any pitch attitude corrections should not exceed one bar width. The angle of bank should never exceed 20 degrees.

**10-11. Instrument Cruising Flight.** As previously mentioned, the constant diligence required to conduct instrument flight produces pilot fatigue. This is especially true on long missions. Utilizing force trim will reduce pilot fatigue. Upon establishing the recommended cruise speed (80 knots), the attitude indicator should be set for a nose level indication. There-

after, any pitch or bank corrections should be made utilizing the attitude indicator. Pitch corrections should not exceed one bar width. The recommended angle of bank for cruising turns is 15 degrees and should not exceed 20 degrees.

#### **Note**

The attitude indicator should never be reset in flight except to align the miniature airplane with the horizon bar. The adjustment is to be always made in straight and level flight at recommended cruise speed.

**10-12.** The VFR cruise speeds are not recommended for instrument cruising because of their close proximity to the speeds at which induced vibration occur.

#### **Caution**

Instrument cruising flight at speeds less than 60 knots IAS is not recommended. The aircraft handling qualities at speeds less than 60 knots (because of power required characteristics) are not compatible with instrument flying.

**10-13. Radio and Navigation Equipment.** The UHF radio reception is poor when large obstructions (building, mountains, etc.) lie between the helicopter and the station. When poor reception is encountered on the ground, attempt to establish (by hovering or changing location) a clear "line of sight" to the communications station. When conducting low level flight in mountainous terrain and poor reception is encountered, climb if possible until readable communications are established.

**10-14. Normal Descents.** Enroute descent to traffic altitude can be initiated and maintained without difficulty using the following procedures.

a. Before commencing the descent, check and reset if necessary, the attitude indicator for a nose level indication with the helicopter in straight and level flight at the recommended cruise speed.

b. To establish the descent, reduce the torque to set up a 500 feet per minute rate of descent and maintain recommended cruise airspeed, angle of bank and pitch attitude. During the

descent the miniature airplane will remain on the horizon bar.

**Note**

In general, below 7000 feet density altitude, a reduction of one pound of torque will increase the rate of descent approximately 100 feet per minute.

**10-15. Maximum (Autorotative) Descents.** Autorotations are used for emergencies (loss of engine, etc.) only. The following procedures are for establishing and conducting autorotations on instruments.

a. Simultaneously reduce collective pitch to maintain desired rotor rpm.

b. Assume a one bar width nose high attitude, and maintain directional control. Approximately a one bar width nose high attitude will give 60 knots IAS, which should be maintained until visual ground contact is made, and a reasonable 2000 to 2400 feet per minute rate of descent. As soon as the autorotation is established and the aircraft is under positive control complete the Engine Failure During Flight, Chapter 4, check list. During the descent limit the angle of bank in turns to 15 degrees.

**10-16. Holding.** Holding presents no handling or control problems if the recommended instrument cruise speed (80 knots indicated) is used. The VFR maximum endurance airspeeds are not recommended for loitering on instruments. The poor instrument handling qualities at these speeds greatly increase the work load at a time when the pilot is busy monitoring radio communications, flying a given set condition, etc. The decrease in fuel consumption realized from using maximum endurance airspeeds instead of 80 knots would be negligible for all practical purposes.

**10-17.** For all pitch and bank corrections, utilize the attitude indicator. Do not exceed a one bar width pitch correction for minor altitude changes and limit the angle of bank in turns of 15 degrees. It is best not to make a collective pitch change unless the airspeed varies more than plus or minus 10 knots indicated.

**10-18. Instrument Approaches.** Before commencing the approach have the attitude indicator properly set (i.e., miniature airplane on horizon bar at a straight and level cruise speed of 80 knots indicated).

**10-19.** For all pitch and bank corrections, utilize the attitude indicator. Do not exceed a one bar width pitch correction for minor altitude changes and limit the angle of bank in turn to 15 degrees.

**10-20.** During the descent phase of an approach, make rate of descent corrections with the cyclic pitch by reference to the attitude indicator. Allow the airspeed to vary plus or minus 10 knots during these corrections before making a collective pitch adjustment.

**10-21. Radio Range And ADF Approach.** Radio Range and ADF approaches are easily conducted by reference to the procedures outlined in figure 10-1. If not VFR at the completion of the approach, execute a missed approach.

**10-22. Ground Control Approach.** The helicopter presents a traffic control problem because of its relatively slow speed compared to other air traffic. Therefore, the GCA operator should be notified that the airspeed will be 80 knots for the entire approach. To reduce the time required to execute a GCA, request a short pattern. This pattern is recommended to have a downwind two to three miles from the runway and four-mile final. If the procedures outlined in figure 10-2 are followed, no problems will be encountered.

**Note**

A normal GCA will require 20 to 25 minutes; whereas short pattern requires only 10 to 15 minutes.

For a 2.8 degree glideslope and zero wind condition, the required rate of descent at 80 knots IAS is 395 fpm. In general, to maintain 80 knots IAS and proper rate of descent, a 1/2 pound increase in torque is required for each 10 knots of head wind and 1/2 pound decrease for each 10 knots of tail wind.

If traffic will permit the GCA will approve, execute missed approach by making 180 degree climbing turn. Proceed under radar control out the GCA final approach reciprocal heading at glide path interception altitude and execute a 90 degree procedure turn after passing through the glide path. Then reinitiate GCA final approach procedures. This will greatly reduce the time required to execute a go around.

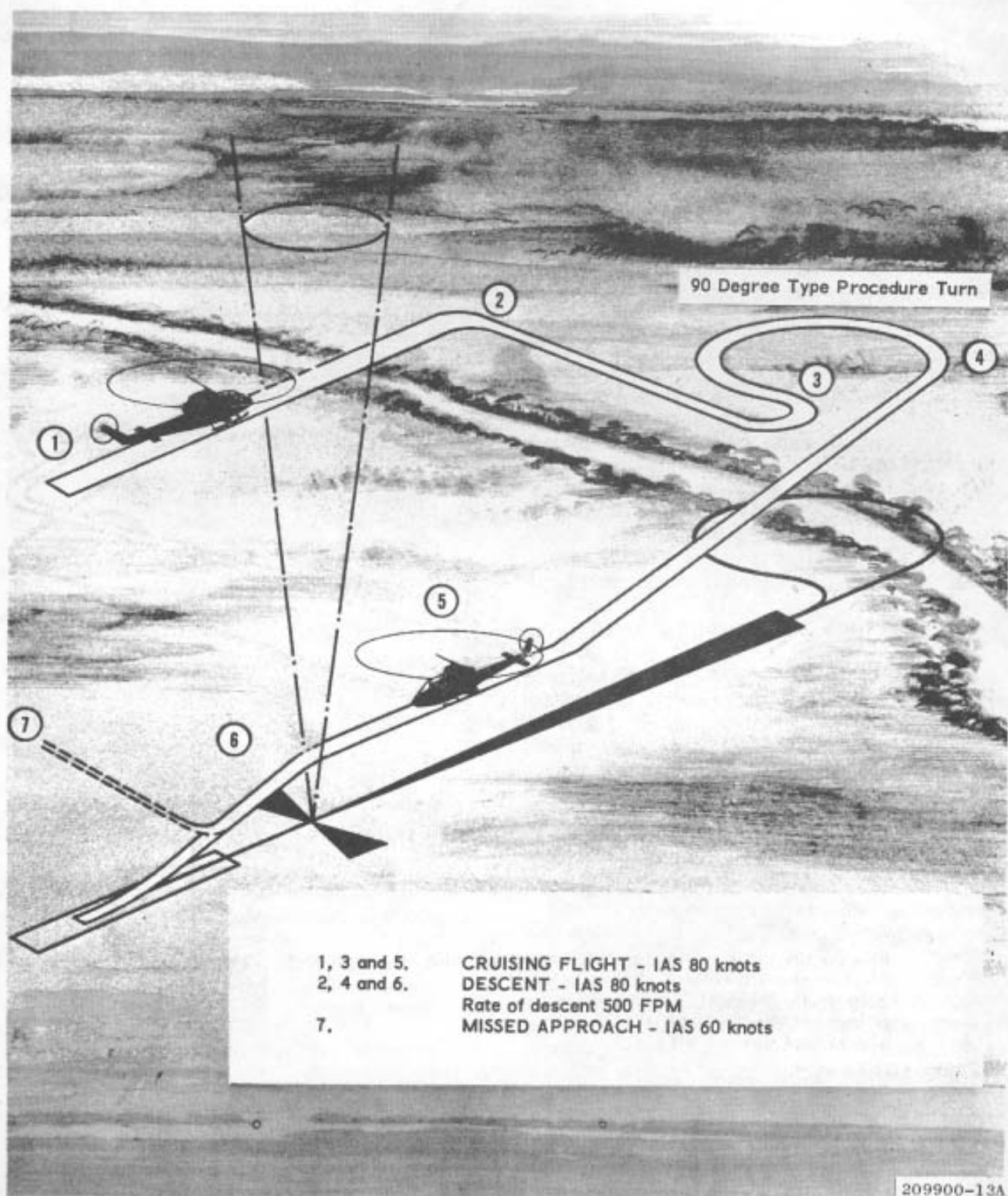
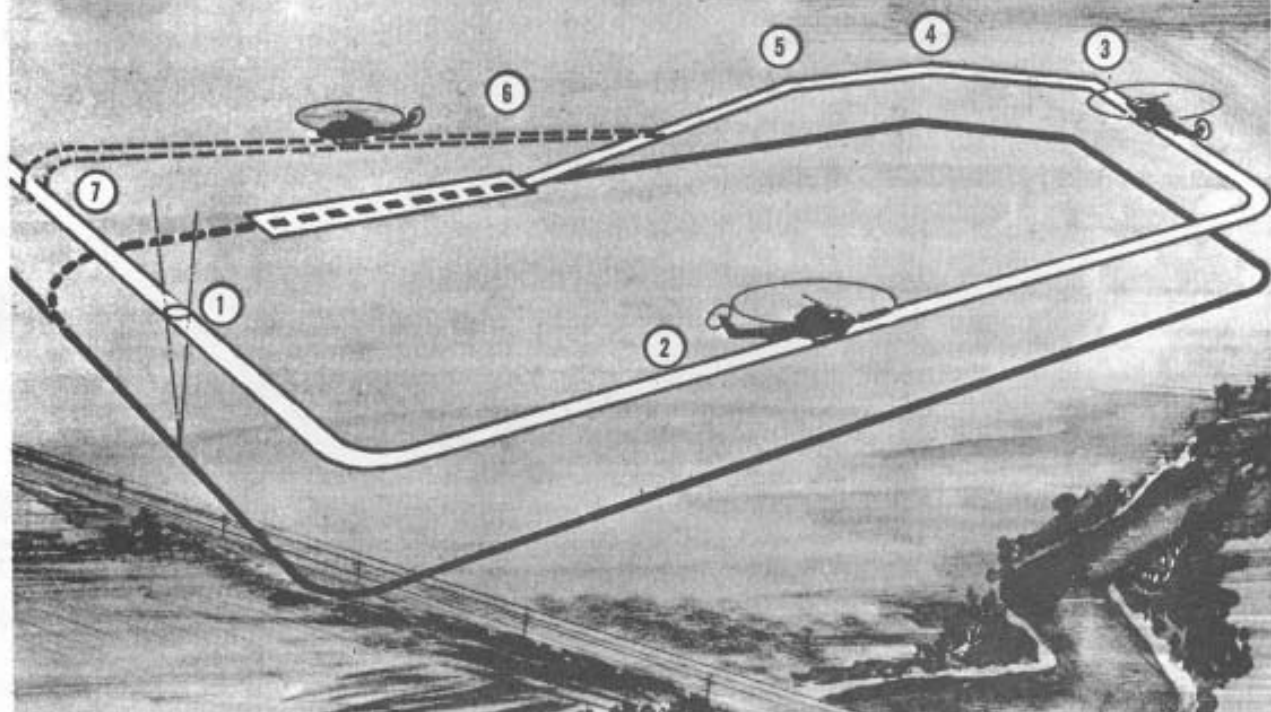

Figure 10-1. Radio range approach



- 1, 2, 4 and 7. PATTERN - IAS 80 knots  
 3 and 5. DESCENTS - IAS 80 knots-  
 Rate of descent 500 FPM  
 6. MISSED APPROACH - IAS 60 knots

**NOTES:**

- Request short pattern 2 to 3 mile downwind - 4 miles turn on to final  
 Glide Patch - 2.8 degrees - IAS 80 knots.  
 Zero wind - 395 FPM  
 10 knot tail wind - 445 FPM  
 10 knot head wind - 345 FPM

209900-12A

Figure 10-2. Ground control approach

**10-23. Missed Approach.** To conduct a missed approach, apply 25 pounds of torque and establish approximately a two bar width nose high attitude indication. After the air-speed decreases to 60 knots indicated, initiate the normal instrument climb procedure.

**10-24. Night Flying.** Night flying presents the same problems as instrument flying, plus additional problems introduced by illumination of the instruments and crew compartment and exterior reflections.

**10-25.** For night take-offs and approaches set landing light approximately 15 degrees "down" from horizontal. This will give the pilot a ref-

erence point during take-off and also light the approximate touch-down area following a normal approach. During take-offs, climbs and approaches use the search light as desired to check the intended flight path for obstructions.

**Note**

Night landings can be made with the navigation lights on steady if the landing and search lights are inoperative. However, exercise extreme caution, since the navigation lights do not furnish sufficient illumination for depth perception until just before touchdown.

**Section III — Cold Weather Operations**

**10-26. Cold Weather Operations.** Operation of the helicopter in cold weather or an arctic environment presents no unusual problems if the operators are aware of those changes that do take place and conditions that may exist because of the lower temperatures and freezing moisture.

**10-27.** The pilot must be more thorough in the walk-around inspection when temperatures have been or are below 0°C (32°F). Water and snow may have entered many parts during operation or in periods when the helicopter was parked unsheltered. This moisture often remains to form ice which will immobilize moving parts or damage structure by expansion and will occasionally foul electric circuitry. Protective covers afford majority protection against rain, freezing rain, sleet, and snow when installed on a dry helicopter prior to the precipitation. Since it is not practicable to completely cover an unsheltered helicopter, those parts not protected by covers and those adjacent to cover overlap and joints require closer attention, especially after a blowing snow or freezing rain. Accumulation of snow and ice should be removed prior to flight. Failure to do so can result in hazardous, flight, due to aerodynamic and center of gravity disturbances as well as the introduction of snow, water and ice into internal moving parts and electrical systems. The pilot should be particularly attentive to the main and tail rotor systems and their exposed control linkages.

**Note**

At temperatures of minus 35°C (minus 31°F) and lower, the grease in the spherical couplings of the main transmission drive shaft may congeal to a point that the couplings cannot operate properly. If found frozen, apply heat to thaw the couplings before attempting to start the engine. Indication of proper operation is obtained by turning the main rotor blade opposite to the direction of rotation while observer watches the drive shaft to see that there is no tendency for the transmission to "wobble" while the drive shaft is turning.

**Caution**

If temperatures are minus 44°C (minus 47°F) or below the pilot must be particularly careful to monitor his engine instruments for too high oil pressure.

**10-28. Before Exterior Check 0°C (32°F) And Lower.** (External Power Available.)

- a. All switches — OFF.
- b. Collective pitch control — DOWN.
- c. Throttle — CLOSED.

d. External power supply connected. Check that dc voltmeter shows proper polarity.

**Note**

The following should be accomplished and the equipment left in warm-up operation during the exterior check.

- e. Inverter switch — MAIN (ON).
- f. Fuel switch — Forward (ON) — Fuel pressure checked.
- g. Radio equipment — ON.
- h. Battery — ON.

**10-29. Before Exterior Check 0°C (32°F) And Lower.** (No External Power Supply Available.)

- a. All switches — OFF.
- b. Collective pitch control — DOWN.
- c. Throttle — CLOSED.

**10-30. Exterior Check 0°C (32°F) to Minus 54°C (65°F).** Perform exterior check as outlined in Chapter 3, paragraph 3-10 plus the following checks.

- a. Fuselage and Main Rotor — Right Side — Area 1.
  - (1) Visually check area clear of ice and snow.

**Note**

Contraction of the oil in the transmission at extreme low temperature causes indication of low oil level. A check made just after the previous shutdown and carried forward to the walk around check is satisfactory if no leaks are in evidence. Filling when the system is cold-soaked will reveal an over-full condition immediately after flight, with the possibility of forced leaks at seals.

- b. Tail Section — Right Side — Area 2.

(1) Synchronized Elevator — Surface free of ice and snow. Check that operation will not

be restricted due to formation of ice between fuselage and elevator.

(2) Visually check area clear of ice and snow.

- c. Tail Section — Right Side — Area 3.

(1) Synchronized Elevator — Surface free of ice and snow. Check that operation will not be restricted due to formation of ice between fuselage and elevator.

(2) Visually check areas clear of ice and snow.

- d. Fuselage and Main Rotor — Left Side — Area 4.

(1) Visually check area clear of ice and snow.

(2) Main Rotor — Untie the blades and walk through 360 degrees in the direction of rotation and check to see that there is no restriction to operation due to ice formation.

**Note**

At temperatures of minus 35°C (minus 31°F) and lower, the grease in the spherical couplings of the main transmission drive shaft may congeal to a point that couplings cannot operate properly. If found frozen, apply heat to thaw the couplings before attempting to start the engine. Indication of proper operation is obtained by turning the main rotor opposite to direction of rotation while observer watches the drive shaft to see that there is no tendency for the transmission to "wobble" while the drive shaft is turning.

- e. Nose Section — Area 5.

(1) Visually check area clear of ice and snow.

**10-31. Interior Check — All Flights 0°C (32°F) to Minus 54°C (65°F).** Perform following check as outlined in Chapter 3, paragraph 3-17 plus the following.

- a. All electrical switches — OFF with exception of the equipment left running to warm up during the exterior check.

**Note**

External power should be used for starting when temperatures are below 0°C (32°F) to prevent draining the battery. When external power is connected, electrical systems will be powered and function normally.

b. Battery switch — ON (OFF if so desired when external power is connected).

c. Generator switch — ON (OFF if external power is connected).

d. External power supply — OPTIONAL (connected for starting at temperatures below 0°C (32°F)).

**10-32. Interior Check — Night Flights 0°C (32°F) to Minus 54°C (65°F). External Power Connected.**

a. Cockpit lights — CHECK.

b. Dome lights — CHECK.

c. Position lights — CHECK.

d. Instrument lights — CHECK.

e. Anti-collision light — CHECK.

**Note**

Use of the anti-collision light on the ground shall be kept to an absolute minimum because excessive heat created in the unit, while on the ground, is detrimental to bulb life, thus increasing maintenance problems. In addition, the operating anti-collision light could confuse rescue operations since emergency ground vehicles use a similar light.

f. Landing and search lights — CHECK.

**10-33. Engine Starting Check 0°C (32°F) to Minus 54°C (65°F).**

Determine that the compressor rotor turns freely. As the engine cools to an ambient temperature below 0°C (32°F) after engine shutdown condensed moisture may freeze engine seals. Ducting hot air from an external source through the air inlet housing will free a frozen rotor.

a. Perform check as outlined in Chapter 3, paragraph 3-18.

**Note**

During cold weather starting the engine oil pressure gage will indicate maximum (100 psi). The engine should be warmed up at flight idle until the engine oil pressure indication is below 100 psi. The time required for warm-up is entirely dependent on the starting temperature of the engine and lubrication system.

**10-34. Engine Run-Up.** Perform the check as outlined in Chapter 3, paragraph 3-19.

**Warning**

Control system checks should be performed with extreme caution when helicopter is parked on snow and ice. There is reduction in ground friction holding the helicopter stationary, controls are sensitive and response is immediate.

**10-35. Cold Weather Capability.** The cold weather capability has been improved in this helicopter with the installation of a nickel-cadmium battery which, because of its partial immunity to low temperatures, can be used to start engine at temperatures down to minus 30°C (minus 22°F). The operator is cautioned that a battery start should only be attempted if the battery is fully charged and that the safety margin for starting is increased if the battery has been warmed. Following each cold weather flight, the pilot should (before shutting down the engine) check the battery for charge using the following procedures:

a. Main rotor speed — minimum 250 rpm, generator ON.

b. Note generator ammeter reading.

c. Switch battery OFF and note CHANGE in reading.

**10-36.** A ten percent change in ammeter reading would indicate a charge rate of 30 amperes and the battery not sufficiently charged for subsequent engine starting. A change of two percent in ammeter reading indicates a charge rate of six amperes and the battery considered

reasonable charged. After a flight of one-half hour or more during which the generator and battery were ON and the generator voltage at 28.5 plus or minus 1.5 volts, a battery charging rate of less than six amperes should be expected.

**10-37. Emergency Engine Starting Without External Power Supply.** If a battery start must be attempted when the helicopter and battery have been cold-soaked at temperatures between minus 26°C to minus 37°C (minus 15°F to minus 35°F), preheat the engine and battery if equipment is available and time permits. Preheating will result in a faster starter cranking speed, which tends to reduce the hot start hazard by assisting the engine in reaching a self-sustaining speed (40 percent nI) in the least possible time.

**10-38. Engine Starting Check.** Perform operations as specified in paragraph 10-33.

#### Caution

⚠ If the engine does not continue to accelerate after ignition is indicated by exhaust gas temperature (EGT) or it gives indication of climbing too fast, maintain EGT below 760°C (1400°F) by closing throttle and holding the starter-ignition switch ON until EGT drops below 650°C (1202°F). Again open the throttle to just short of the flight idle stop. With the helicopter and battery cold-soaked at minus 30°C (minus 22°F) or lower, the unassisted battery start may require two or even three throttle closing actions to control EGT before the engine accelerates to a self sustaining speed (40 percent nI rpm).

#### Warning

During an unassisted battery start, the throttle must be positioned between the flight idle stop and the off position, because the electrical power necessary to release the flight idle stop may not be available due to the high battery drain during engine starter operation. To insure adequate fueling, place close to the flight idle stop.

**10-39. Take-Off.** Snow take-off from an air base may be considered normal except for the following precautions that should be observed.

#### Warning

Under cold weather conditions, make sure all instruments have warmed up sufficiently to insure normal operation. Check for sluggish instruments before take-off.

a. Select an area that is free of loose or powdery snow to minimize the restriction to visibility from blowing snow.

b. Before attempting to take-off make sure the landing gear skids are free and not frozen to the surface.

c. The first take-off after a cold start should include a visual check of the ground surface for evidence of hydraulic leaks. This should be done under hovering power conditions. If hydraulic leaks are present, further flight should be aborted.

**10-40. Landing.** Snow landing at an air base may be considered normal except for the following precautions that should be observed:

a. Select an area free of loose or powdery snow so that visibility will not be restricted by blowing snow.

b. Accomplish a normal landing with a minimum hover before touchdown. Limited visibility will result from swirling snow, when hovering is attempted before making a touchdown.

**10-41. Evaluation of Strange Area Snow Landing Site.** Landings may often be necessary in areas other than operational air bases. In addition to the basic factors in landing site evaluation, factors pertinent to snow landings are outlined in this paragraph.

a. The pilot should have knowledge of the type of terrain under the snow (bush, marsh land, tundra, etc.).

b. The snow depth is usually less in clear areas where there is little drifting snow effect. Clean areas normally form gentle swells with the crests of these swells usually crusted. The heaviest crust will generally be found on the upwind side of the crests.

c. Deep snow is usually found in the valleys and to the 'lee'. These areas are suitable for landings and take-offs if caution is exercised.

**10-42. Landing.** a. Anticipate loose powdery snow and crusts on all landings on snow.

b. Landings should always be made when visual ground reference can be maintained. The reference point should be kept forward and to the right so that it will be visible to the pilot at all times.

**Note**

When making an approach and landing on snow it should be one continuous operation without extended hover in order to reduce the white-out condition that results from extended hovering over snow. This white-out will usually occur on loose snow and can cause the pilot to lose all reference with the ground or any object he is approaching. If the object being used as reference should become completely obscured, accomplish a go-round.

**10-43. High Altitude Operation — Preparation for Flight.** a. Determine the density altitude for the area into which the flight is intended and compute maximum gross weight at which a hover may be possible.

b. Determine the existing and forecast wind conditions whenever possible.

c. Insofar as practicable, plan the flight to avoid known and probable areas of turbulence.

**10-44. Engine Starting.** (Refer to Chapter 3.)

**10-45. Take-Off.** The take-off should be made to obtain airspeed and altitude simultaneously. The take-off should begin with a slow acceleration to obtain translational lift, followed by a gradual increase in power and airspeed until a normal climb is attained.

**10-46. In Flight Operations.** a. All turns should be shallow. Avoid turns close to the ground.

b. Control movements should be gentle.

c. Sufficient altitude should be maintained to allow for any emergency keeping in mind the high rate of autorotational descent associated with high altitudes.

d. Forward airspeed should be limited to prevent blade stall, which is preceded by blade "buffeting".

e. Avoid areas of known turbulence such as the base of clouds, the 'lee' side of mountains, and steep canyons.

**10-47. Descent.** a. All descents should be gradual. Under no circumstances should a high rate of descent be allowed to develop.

b. Caution should be used during descents to maintain a safe airspeed. Increasing the airspeed above normal approach speed can cause the rate of descent to increase very rapidly. Low airspeed may also result in a high rate of descent, and when the nose is lowered in recovery the condition is aggravated.

c. Power applications should be anticipated because the gas turbine engine does not respond at high altitudes as rapidly as at lower elevation.

**10-48. Landing.** All approaches to landings should be planned and performed in an area of suitable level ground.

**10-49. Autorotation.** Autorotations at high altitudes are characterized by higher rates of descent and less effective collective pitch control available to cushion the landings.

**Note**

An airspeed of approximately 60 knots should be maintained during autorotation. At an altitude of 75 to 85 feet, initiate a flare to decrease airspeed and rate of descent. At approximately 10 to 12 feet, a small amount of pitch should be applied with the helicopter still in a flare attitude. Maintain approximately 20 to 25 knots forward speed to further decrease the rate of descent. The helicopter should then be leveled and when about 6 to 12 inches above ground, sufficient collective pitch should be applied to cushion the touchdown. Caution should be used to avoid a vertical descent during the last 5 to 10 feet.

**Caution**

Practice autorotations at high altitudes should be made only to prepared landing areas, even when a power recovery is anticipated. Power recoveries should not be initiated below 400 to 500 feet altitude depending upon helicopter weight and field elevation, due to a combination of slow engine accele-

ration characteristics, high rotor blade angle of attack and accompanying drag, and the probability of encountering a high rate of descent. The presence of these factors make a quick power recovery impossible. The altitude at which safe power recovery should be initiated increases with helicopter gross weight and/or field elevation.

**Section IV — Desert And Hot Weather Operations**

**10-50. Hot Weather Operations.** Operations when outside air temperatures are above standard conditions, do not require any special handling technique or procedures, other than a closer monitoring of oil temperatures and EGT.

**10-51. High Ambient Temperatures.** At very high ambient temperatures, the helicopter loses efficiency with high gross weights.

**Section V — Turbulence And Thunderstorm Operations**

**10-52. Turbulence And Thunderstorms.** Flight in thunderstorms and heavy rain that accompanies thunderstorms should be avoided. If turbulence and thunderstorms are encountered in flight, the helicopter forward speed should be reduced to reduce buffeting and increase ease of control.

the pilot should not attempt to maintain a definite altitude. All attention should be directed to maintaining track and a level attitude. The helicopter should be set up for normal instrument cruise conditions. Donot make a collective pitch change unless the airspeed varies over plus or minus 10 knots.

**10-53. Turbulence During Instrument Flight.** The helicopter instrument handling qualities are very poor in turbulence. If moderate to severe turbulence is unavoidably encountered,

**Note**

The turbulence penetration speed is 80 KNOTS IAS.

**CHAPTER 11**  
**CREW DUTIES**

**Note**

Crew duties are listed in Chapter 3  
and Chapter 6.



## CHAPTER 12

## WEIGHT AND BALANCE COMPUTATION

## Section I — Scope

**12-1. Function.** This Chapter contains sufficient instructions and data so that an airman, knowing the basic weight and moment of the helicopter, can compute any combinations of weight and balance.

**12-2.** No computers are provided for the helicopter, hence no computer instruction is included.

## Section II — Introduction

## Note

For the purpose of clarity, Model AH-1G helicopters are in class I category. Additional directives governing weight and balance of Class I aircraft are contained in Army Regulations 95-16.

**12-3. Introduction.** The purpose of this Chapter is to provide appropriate information required for the computation of weight and balance for loading an individual helicopter. It is assumed that the crew member has available, the current basic weight and moment of the particular helicopter. Accordingly this Chapter contains definitions of weight and balance, and explanations of Chart C—Basic Weight and Balance record DD Form 365C (the source of the basic weight and moment); Chart E—Loading Data, Charts and Graphs; and a practical example of a loading problem using weight and balance clearance form, F, DD Form 365F.

**12-4.** The basic weights and cg location obtained from a weighing can only be as accurate as the scale equivalent employed. Scales must be calibrated as required by existing directives.

## Section III — Definitions

**12-5. Weight Definitions.** Weight definitions are described in the following paragraphs:

**12-6. Basic Weight.** The basic weight of a helicopter, is the weight which includes all fixed operating equipment and trapped fuel and oil, to which it is only necessary to add the "variable" or "expendable" load items for the various missions.

## Note

The basic weight of a helicopter varies with structural modifications

and changes in the fixed operating equipment. The term "basic weight", when qualified with a word indicating the type of mission such as "Basic Weight for Combat", etc., may be used in conjunction with those directives which state what equipment shall be utilized for these missions. For example, various items of equipment installed for long range ferry flights, and which are not normally carried on combat missions, will be included in "Basic Weight for Ferry", but not in the "Basic Weight for Combat".

**12-7. Operating Weight.** The operating weight of a helicopter is the basic weight plus those "variable" items which remain substantially constant for the type mission. These items include oil, crew, crew's baggage, emergency and extra equipment that may be required.

**Note**

In the case of special mission helicopters, the operating weight is the weight of the helicopter including the crew and all the equipment required for the mission, but excluding fuel or payload.

**12-8. Gross Weight.** The gross weight is the total weight of a helicopter plus its contents, as follows:

a. The take-off gross weight is the operating weight plus the variable and expendable load items which may vary with the mission. These items include fuel, cargo, passengers, ammunition, etc.

b. The landing gross weight is the take-off gross weight minus the expended load items.

**12-9. Balance Definitions.** Balance definitions are described in the following paragraphs:

**12-10. Reference Datum.** Reference datum is an imaginary vertical plane at the nose of the helicopter from which all horizontal distances are measured for balance purposes. This datum is referenced as station 0.0.

**12-11. Arm.** For balance purposes arm is the horizontal distance in inches from the reference datum to the cg of a given item. Arms may be determined from the helicopter diagram contained in Chart E.

**12-12. Moment.** Moment is the weight of an item multiplied by its arm. Moment divided by

a constant is generally used to simplify balance calculations by reducing the number of digits.

**Note**

Inches from reference datum and moment/100 has been used on Charts F, C, E for calculating weight and balance. The same units of dimension and moment/constant must be additions to these charts.

**12-13. Average Arm.** Average arm is the arm obtained by adding the weight and adding the moments of a number of items and then dividing the total moment by a total weight.

**12-14. Basic Moment.** Basic moment is the sum of the moments of all items making up the basic weight. When using data from an actual weighing of a helicopter, the basic moment is the total moment of the basic helicopter with respect to the reference datum.

**12-15. Center of Gravity (CG).** The center of gravity is a point about which a helicopter would balance if suspended. Its distance from the reference datum is found by dividing the total moment by the gross weight of the helicopter.

**12-16. CG Limits.** The cg limits are the extremes of movement which the cg can have without making the helicopter unsafe to fly. The cg of the loaded helicopter must be within those limits at take-off, in the air, and on landing. In some cases, separate take-off and landing limits may be specified.

**12-17. Balance Computer Index.** Balance computer index is a number representing the moment which, when considered in conjunction with the weight, gives the cg position.

**Section IV — Chart Explanations**

**12-18. Chart C — Basic Weight and Balance Record — DD Form 365C.** Chart C is a continuous history of the basic weight and moment resulting from structural and equip-

ment changes. At all times the last weight and moment/constant entry is considered in current weight and balance status of the basic helicopter.

**12-19. Use.** (Refer to figure 12-1 for a sample of DD Form 365C.) At time of delivery of a new helicopter, the manufacturer entered the basic weight and moment/constant of the individual helicopter. This chart becomes a part of the "G" file of the helicopter. Subsequent additions or subtractions to the basic weight and moment/constant on Chart C are made by the weight and balance technician.

**12-20. Chart E — Loading Data.** The loading data on Chart E are intended to provide information necessary to work a loading problem for the helicopters to which this manual is applicable.

**12-21. Use.** From the loading table contained in Chart E (see figure 12-2) weight and moment/constant are obtained for all variable load items and are added arithmetically to the current basic weight and moment/constant (from Chart C) to obtain the gross weight and moment.

a. The cg of the loaded helicopter is represented by a moment figure opposite the gross weight of the table.

b. If the helicopter is loaded within the forward and aft cg limits, the moment figure will fall numerically between the limiting moments.

c. The effect on cg by the expenditure in flight of such items as fuel, ammunition, etc., may be checked by subtracting the weights and moments of such items from the take-off gross weight and moment and checking the new moment with the cg table.

**Note**

This check should be made to determine whether or not the cg will remain within limits during the entire flight.



Chart: E  
 Sheet: 1 of 11  
 Model: AH-1G  
 Chart Date: January 9, 1967  
 S/N 66-15247 thru 66-15357

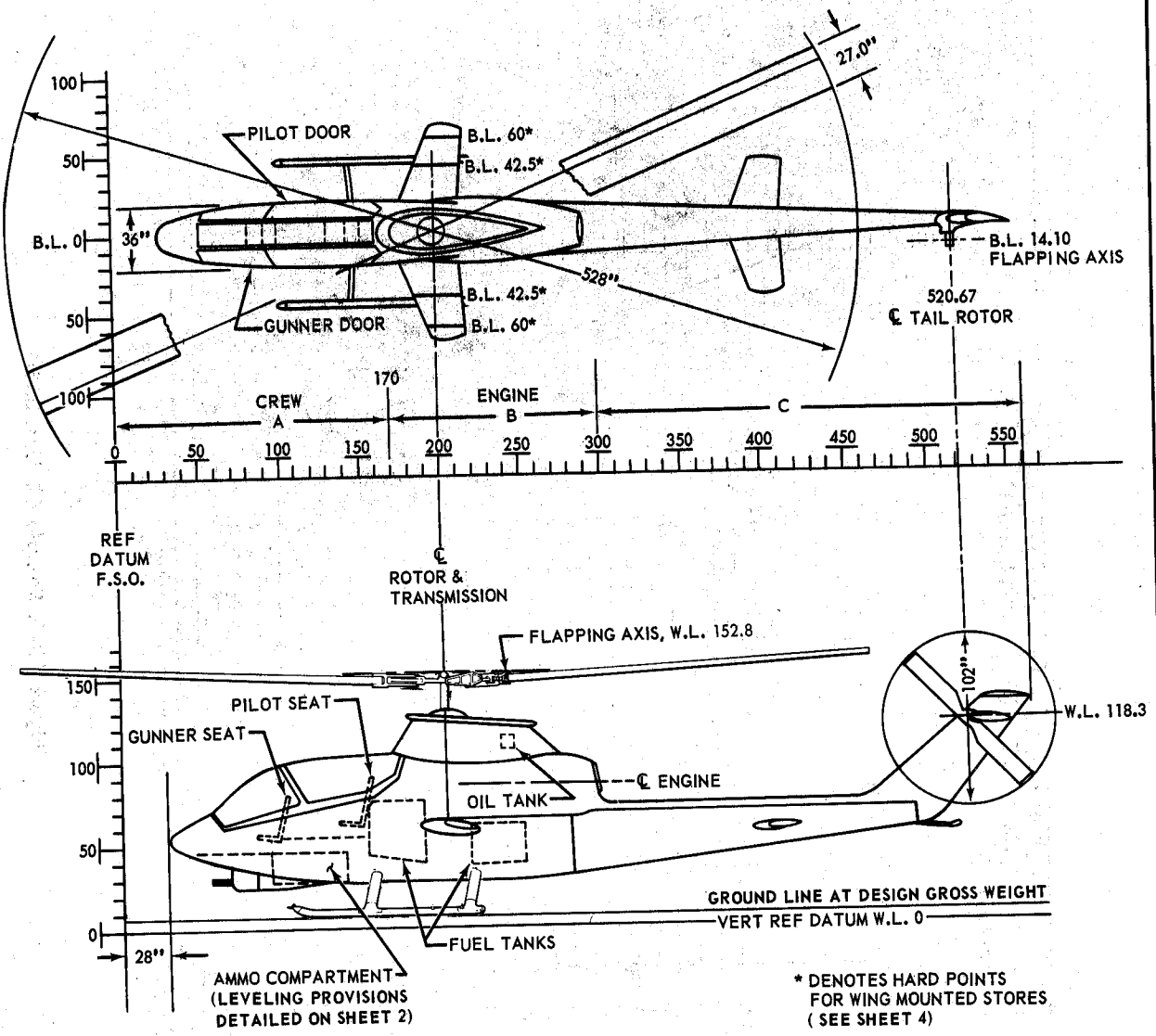

209900-5A

Figure 12-2. Chart E — loading data (Sheet 1 of 11)

Chart: E  
Sheet: 2 of 11  
Model: AH-1G  
Chart Date: See Sheet 1

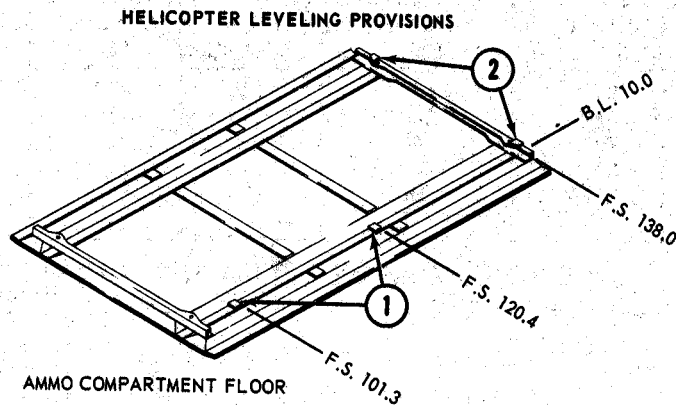
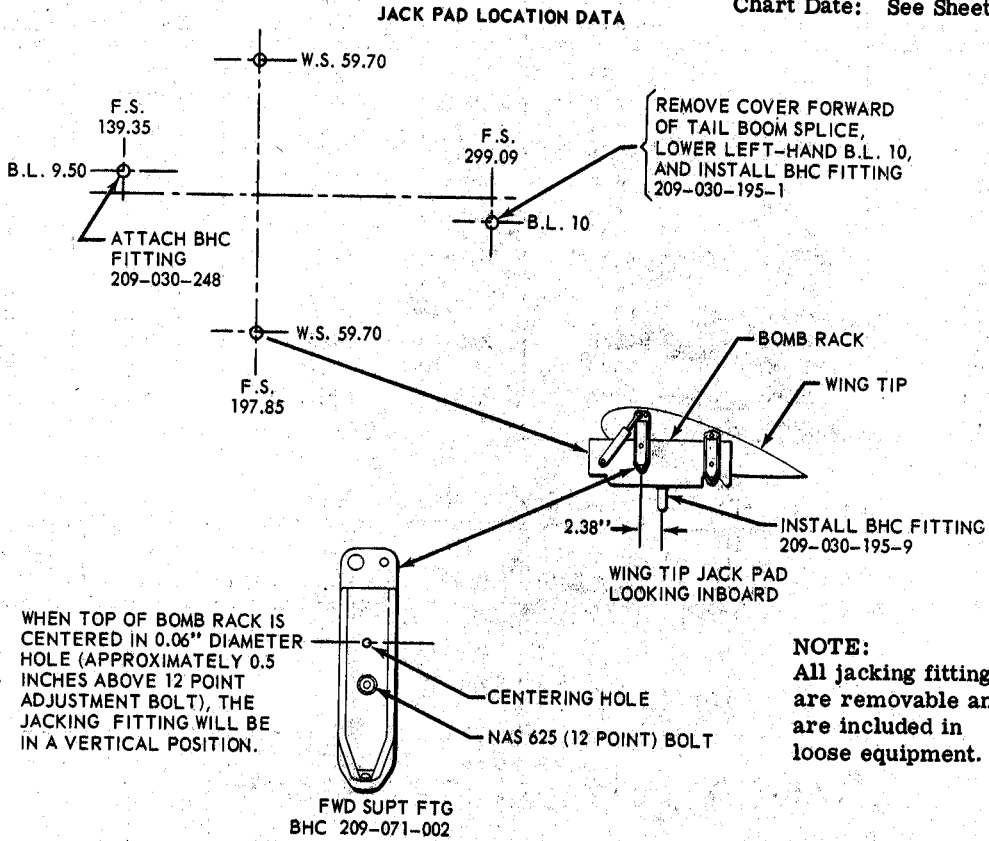

- (1) PADS FOR HORIZONTAL LEVELING LOCATED IN DEPRESSION NEAR LEFT SIDE OF FLOOR. PALLET MUST BE REMOVED
- (2) PADS FOR LATERAL LEVELING LOCATED ON TOP OF AFT AMMO PALLET TRACK

209900-19

Figure 12-2. Chart E — loading data (Sheet 2 of 11)

**FUEL LOADING TABLE**  
**INTERCONNECTED FUSELAGE TANKS**

Chart: E  
Sheet: 3 of 11  
Model: AH-1G  
Chart Date: See sheet 1

Gal.	Weight (6.5 Lbs/Gal.)	Fuselage Station	Moment/100	Gal.	Weight (6.5 Lbs/Gal.)	Fuselage Station	Moment/100
10	65	209.0	136	150	975	203.7	1986
20	130	207.7	270	160	1040	203.6	2117
30	195	206.5	403	170	1105	203.6	2250
40	260	205.5	534	180	1170	203.6	2382
50	325	205.0	666	190	1235	203.5	2513
60	390	204.6	798	200	1300	203.5	2646
70	455	204.4	930	210	1365	203.5	2778
80	520	204.2	1062	220	1430	203.4	2909
90	585	204.1	1194	230	1495	203.2	3038
100	650	204.0	1326	240	1560	201.8	3148
110	715	203.9	1458	250	1625	200.5	3258
120	780	203.8	1590	260	1690	199.3	3368
130	845	203.8	1722	270	1755	198.1	3477
140	910	203.7	1854				

**TANK OIL LOADING TABLE**

Gal.	Weight (Lbs.)	Moment/100 Sta. 234.1	Gal.	Weight (Lbs.)	Moment/100 Sta. 234.1
.5	4	9	2.5	19	45
1.0	8	19	3.0	23	54
1.5	11	26	3.5	26	61
2.0	15	35			

**TABLE OF MOMENTS FOR PERSONNEL**

GUNNER, F.S. 83.0

PILOT, F. S. 135.0

Weight (Lbs)	Moment 100	Weight (Lbs)	Moment 100	Weight (Lbs)	Moment 100	Weight (Lbs)	Moment 100
150	125	210	174	150	203	210	284
160	133	220	183	160	216	220	297
170	141	230	191	170	230	230	311
180	149	240	199	180	243	240	324
190	158	250	208	190	257	250	338
200	166			200	270		

**SMOKE GRENADE LOADING TABLE**

WHITE

COLORED

No.	Weight @ 1.75 Lbs. EA	Launcher		No.	Weight @ 1.0 Lbs. EA	Launcher	
		Forward (F.S. 255) Moment/100	Aft (F.S. 265) Moment/100			Forward (F.S. 255) Moment/100	Aft (F.S. 265) Moment/100
1	2	5	5	1	1	3	3
2	4	9	9	2	2	5	5
3	5	13	14	3	3	8	8
4	7	18	19	4	4	10	11
5	9	22	23	5	5	13	13
6	11	27	28	6	6	15	16

Figure 12-2. Chart E — loading data (Sheet 3 of 11)

AMMUNITION LOADING TABLE

Chart: E  
Sheet: 4 of 11  
Model: AH-1G  
Chart Date: See Sheet 1

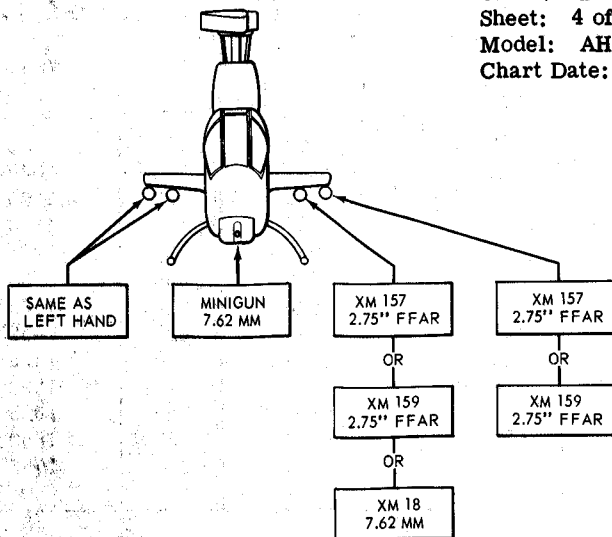

7.62MM AMMO - AMMO COMPARTMENT			
ROUNDS	WEIGHT (LBS) (1)	MOMENT/100	
		FWD BOX F.S. 108.4	AFT BOX F.S. 125.9
250	16	18	20
500	33	35	41
750	49	53	61
1000	65	70	82
1250	81	88	102
1500	98	106	123
1750	114	123	143
2000	130	141	164
2250	146	159	184
2500	163	176	205
2750	179	194	225
3000	195	211	246
3250	211	229	266
3500	228	247	286
3750	244	264	307
4000	260	282	327

2.75" FFAR ROCKETS			
NO.	WEIGHT (LBS) (3)	MOMENT/100	
		INBOARD F.S. 190.7	OUTBOARD F.S. 194.7
1	22	41	42
2	43	82	84
3	65	124	126
4	86	165	168
5	108	206	210
6	130	247	252
7	151	288	294
8	173	330	336
9	194	371	378
10	216	412	421
11	238	453	463
12	259	494	505
13	281	535	547
14	302	577	589
15	324	618	631
16	346	659	673
17	367	700	715
18	389	741	757
19	410	783	799

7.62MM AMMO		
ROUNDS	WEIGHT (LBS) (2)	MOMENT/100
		INBOARD F.S. 202.0
250	14	28
500	28	56
750	41	83
1000	55	111
1250	69	139
1500	83	167

- (1) 7.62MM AMMO, Linked, @ 0.065 LBS/ROUND
- (2) 7.62MM AMMO, Linkless, @ 0.055 LBS/ROUND
- (3) 2.75" FFAR rocket @ 21.6 LBS each

209900-20

Figure 12-2. Chart E — loading data (Sheet 4 of 11)



CHART E  
SHEET 5 of 11  
MODEL AH-1G  
CHART DATE: See Sheet 1

**CENTER OF GRAVITY TABLE**

Moment/100

Approximate flight limits shown by heavy vertical line. Numbers in **bold face** are actual moment limits for weights indicated but not for stations shown in column head.

GROSS WEIGHT (POUNDS)	Approximate flight limits shown by heavy vertical line. Numbers in <b>bold face</b> are actual moment limits for weights indicated but not for stations shown in column head.								
	190.0	191.0	192.0	194.0	196.0	198.0	200.0	201.0	201.3
5200	9880	9932	<b>9984</b>	10088	10192	10296	10400	10452	10468
5225	9928	9980	10032	10137	10241	10346	10450	10502	10518
5250	9975	10028	10080	10185	10290	10395	10500	10553	10568
5275	10023	10075	10128	10234	10339	10445	10550	10603	10619
5300	10070	10123	10176	10282	10388	10494	10600	10653	10669
5325	10118	10171	10224	10331	10437	10544	10650	10703	10719
5350	10165	10219	10272	10379	10486	10593	10700	10754	10770
5375	10213	10266	10320	10428	10535	10643	10750	10804	10820
5400	10260	10314	10368	10476	10584	10692	10800	10854	10870
5425	10308	10362	10416	10525	10633	10742	10850	10904	10921
5450	10355	10410	10464	10573	10682	10791	10900	10955	10971
5475	10403	10457	10512	10622	10731	10841	10950	11005	11021
5500	10450	10505	10560	10670	10780	10890	11000	11055	11072
5525	10498	10553	10608	10719	10829	10940	11050	11105	11122
5550	10545	10601	10656	10767	10878	10989	11100	11156	11172
5575	10593	10648	10704	10816	10927	11039	11150	11206	11222
5600	10640	10696	10752	10864	10976	11088	11200	11256	11273
5625	10688	10744	10800	10913	11025	11138	11250	11306	11323
5650	10735	10792	10848	10961	11074	11187	11300	11357	11373
5675	10783	10839	10896	11010	11123	11237	11350	11407	11424
5700	10830	10887	10944	11058	11172	11286	11400	11457	11474
5725	10878	10935	10992	11107	11221	11336	11450	11507	11524
5750	10925	10983	11040	11155	11270	11385	11500	11558	11575
5775	10973	11030	11088	11204	11319	11435	11550	11608	11625
5800	11020	11078	11136	11252	11368	11484	11600	11658	11675
5825	11068	11126	11184	11301	11417	11534	11650	11708	11726
5850	11115	11174	11232	11349	11466	11583	11700	11759	11776
5875	11163	11221	11280	11398	11515	11633	11750	11809	11826
5900	11210	11269	11328	11446	11564	11682	11800	11859	11877
5925	11258	11317	11376	11495	11613	11732	11850	11909	11927
5950	11305	11365	11424	11543	11662	11781	11900	11960	11977
5975	11353	11412	11472	11592	11711	11831	11950	12010	12028
6000	11400	11460	11520	11640	11760	11880	12000	12060	12078
6025	11448	11508	11568	11689	11809	11930	12050	12110	12128
6050	11495	11556	11616	11737	11858	11979	12100	12161	12179
6075	11543	11603	11664	11786	11907	12029	12150	12211	12229
6100	11590	11651	11712	11834	11956	12078	12200	12261	12279
6125	11638	11699	11760	11883	12005	12128	12250	12311	12330

Figure 12-2. Chart E — loading data (Sheet 5 of 11)

CHART E  
SHEET 6 of 11  
MODEL AH-1G  
CHART DATE: See Sheet 1

**CENTER OF GRAVITY TABLE**

Moment/100

GROSS WEIGHT (POUNDS)	Approximate flight limits shown by heavy vertical line. Numbers in <b>bold face</b> are actual moment limits for weights indicated but not for stations shown in column head								
	190.0	191.0	192.0	194.0	196.0	198.0	200.0	201.0	201.3
6150	11685	11747	11808	11931	12054	12177	12300	12362	12380
6175	11733	11794	11856	11980	12103	12227	12350	12412	12430
6200	11780	11842	11904	12028	12152	12276	12400	12462	12481
6225	11828	11890	11952	12077	12201	12326	12450	12512	12531
6250	11875	11938	12000	12125	12250	12375	12500	12563	12581
6275	11923	11985	12048	12174	12299	12425	12550	12613	12632
6300	11970	12033	12096	12222	12348	12474	12600	12663	12682
6325	12018	12081	12144	12271	12397	12524	12650	12713	12732
6350	12065	12129	12192	12319	12446	12573	12700	12764	12783
6375	12113	12176	12240	12368	12495	12623	12750	12814	12833
6400	12160	12224	12288	12416	12544	12672	12800	12864	12883
6425	12208	12272	12336	12465	12593	12721	12850	12914	12934
6450	12255	12320	12384	12513	12642	12771	12900	12965	12984
6475	12303	12367	12432	12562	12691	12821	12950	13015	13034
6500	12350	12415	12480	12610	12740	12870	13000	13065	13085
6525	12398	12463	12528	12659	12789	12920	13050	13115	13135
6550	12445	12511	12576	12707	12838	12969	13100	13166	13185
6575	12493	12558	12624	12756	12887	13019	13150	13216	13235
6600	12540	12606	12672	12804	12936	13068	13200	13266	13286
6625	12588	12654	12720	12853	12985	13118	13250	13316	13336
6650	12635	12702	12768	12901	13034	13167	13300	13367	13386
6675	12683	12749	12816	12950	13083	13217	13350	13417	13437
6700	12730	12797	12864	12998	13132	13266	13400	13467	13487
6725	12778	12845	12912	13047	13181	13316	13450	13517	13537
6750	12825	12893	12960	13095	13230	13365	13500	13568	13588
6775	12873	12940	13008	13144	13279	13415	13550	13618	13638
6800	12920	12988	13056	13192	13328	13464	13600	13668	13688
6825	12968	13036	13104	13241	13377	13514	13650	13718	13739
6850	13015	13084	13152	13289	13426	13563	13700	13769	13789
6875	13063	13131	13200	13338	13475	13613	13750	13819	13839
6900	13110	13179	13248	13386	13524	13662	13800	13869	13890
6925	13158	13227	13296	13435	13573	13712	13850	13919	13940
6950	13205	13275	13344	13483	13622	13761	13900	13970	13990
6975	13253	13322	13392	13532	13671	13811	13950	14020	14041
7000	13300	13370	13440	13580	13720	13860	14000	14070	14091
7025		13418	13488	13629	13769	13910	14050	14120	14141
7050	13398	13466	13536	13677	13818	13959	14100	14171	14192
7075		13513	13584	13726	13867	14009	14150	14221	14242

Figure 12-2. Chart E — loading data (Sheet 6 of 11)

CHART E  
SHEET 7 of 11  
MODEL AH-1G  
CHART DATE: See Sheet 1

### CENTER OF GRAVITY TABLE

Moment/100

Approximate flight limits shown by heavy vertical line. Numbers in **bold face** are actual moment limits for weights indicated but not for stations shown in column head

GROSS WEIGHT (POUNDS)	Approximate flight limits shown by heavy vertical line. Numbers in <b>bold face</b> are actual moment limits for weights indicated but not for stations shown in column head								
	190.0	191.0	192.0	194.0	196.0	198.0	200.0	201.0	201.3
7100	<b>13496</b>	13561	13632	13774	13916	14058	14200	14271	14292
7125		13609	13680	13823	13965	14108	14250	14321	14343
7150	<b>13594</b>	13657	13728	13871	14014	14157	14300	14372	14393
7175		13704	13776	13920	14063	14207	14350	14422	14443
7200	<b>13692</b>	13752	13824	13968	14112	14256	14400	14472	14494
7225		13800	13872	14017	14161	14306	14450	14522	14544
7250	<b>13790</b>	13848	13920	14065	14210	14355	14500	14573	14594
7275		13895	13968	14114	14259	14405	14550	14623	14645
7300	<b>13888</b>	13943	14016	14162	14308	14454	14600	14673	14695
7325		13991	14064	14211	14357	14504	14650	14723	14745
7350	<b>13986</b>	14039	14112	14259	14406	14553	14700	14774	14796
7375		14086	14160	14308	14455	14603	14750	14824	14846
7400	<b>14084</b>	14134	14208	14356	14504	14652	14800	14874	14896
7425		14182	14256	14405	14553	14702	14850	14924	14947
7450	<b>14182</b>	14230	14304	14453	14602	14751	14900	14975	14997
7475		14277	14352	14502	14651	14801	14950	15025	15047
7500	<b>14280</b>	14325	14400	14550	14700	14850	15000	15075	15098
7525		14373	14448	14599	14749	14900	15050	15125	15148
7550	<b>14378</b>	14421	14496	14647	14798	14949	15100	15176	15198
7575		14468	14544	14696	14847	14999	15150	15226	15248
7600	<b>14476</b>	14516	14592	14744	14896	15048	15200	15276	15299
7625		14564	14640	14793	14945	15098	15250	15326	15349
7650	<b>14575</b>	14612	14688	14841	14994	15147	15300	15377	15399
7675		14659	14736	14890	15043	15197	15350	15427	15450
7700	<b>13673</b>	14707	14784	14938	15092	15246	15400	15477	15500
7725		14755	14832	14987	15141	15296	15450	15527	15550
7750	<b>14772</b>	14803	14880	15035	15190	15345	15500	15578	15601
7775		14850	14928	15084	15239	15395	15550	15628	15651
7800	<b>14870</b>	14898	14976	15132	15288	15444	15600	15678	15701
7825		14946	15024	15181	15337	15494	15650	15728	15752
7850	<b>14968</b>	14994	15072	15229	15386	15543	15700	15779	15802
7875		15041	15120	15278	15435	15593	15750	15829	15852
7900	<b>15067</b>	15089	15168	15326	15484	15642	15800	15879	15903
7925		15137	15216	15375	15533	15692	15850	15929	
7950	<b>15165</b>	15185	15264	15423	15582	15741	15900	15980	16000
7975		15232	15312	15472	15631	15791	15950	16030	
8000	<b>15264</b>	15280	15360	15520	15680	15840	16000	16080	16098
8025		15328	15408	15569	15729	15890	16050	16130	

Figure 12-2. Chart E — loading data (Sheet 7 of 11)

CHART E  
SHEET 8 of 11  
MODEL AH-1G  
CHART DATE: See Sheet 1

### CENTER OF GRAVITY TABLE

Moment/100

GROSS WEIGHT (POUNDS)	Approximate flight limits shown by heavy vertical line. Numbers in <b>bold face</b> are actual moment limits for weights indicated but not for stations shown in column head								
	190.0	191.0	192.0	194.0	196.0	198.0	200.0	201.0	201.3
8050	<b>15363</b>	15376	15456	15617	15778	15939	16100	16181	<b>16195</b>
8075		15423	15504	15666	15827	15989	16150	16231	
8100	<b>15461</b>	15471	15552	15714	15876	16038	16200	16281	<b>16292</b>
8125		15519	15600	15763	15925	16088	16250	16331	
8150	<b>15560</b>	15567	15648	15811	15974	16137	16300	16382	<b>16389</b>
8175		15614	15696	15860	16023	16187	16350	16432	
8200	<b>15659</b>	15662	15744	15908	16072	16236	16400	16482	<b>16487</b>
8225		15710	15792	15957	16121	16286	16450	16532	
8250		<b>15758</b>	15840	16005	16170	16335	16500	16583	<b>16584</b>
8275			15888	16054	16219	16385	16550	16633	
8300		<b>15856</b>	15936	16102	16268	16434	16600	16681	
8325			15984	16151	16317	16484	16650		
8350		<b>15955</b>	16032	16199	16366	16533	16700	16778	
8375			16080	16248	16415	16583	16750		
8400		<b>16054</b>	16128	16296	16464	16632	16800	16875	
8425			16176	16345	16513	16682	16850		
8450		<b>16153</b>	16224	16393	16562	16731	16900	16972	
8475			16272	16442	16611	16781	16950		
8500		<b>16252</b>	16320	16490	16660	16830	17000	17069	
8525			16368	16539	16709	16880	17050		
8550		<b>16351</b>	16416	16587	16758	16929	17100	17166	
8575			16464	16636	16807	16979	17150		
8600		<b>16450</b>	16512	16684	16856	17028	17200	17263	
8625			16560	16733	16905	17078	17250		
8650		<b>16549</b>	16608	16781	16954	17127	17300	17360	
8675			16656	16830	17003	17177	17350		
8700		<b>16648</b>	16704	16878	17052	17226	17400	17457	
8725			16752	16927	17101	17276	17450		
8750		<b>16748</b>	16800	16975	17150	17325	17500	17553	
8775			16848	17024	17199	17375	17550		
8800		<b>16847</b>	16896	17072	17248	17424	17600	17650	
8825			16944	17121	17297	17474	17650		
8850		<b>16946</b>	16992	17169	17346	17523	17700	17747	
8875			17040	17218	17395	17573	17750		
8900		<b>17045</b>	17088	17266	17444	17622	17800	17843	
8925			17136	17315	17493	17672	17850		
8950		<b>17145</b>	17184	17363	17542	17721	17900	17940	
8975			17232	17412	17591	17771	17950		

Figure 12-2. Chart E — loading data (Sheet 8 of 11)

CHART E  
SHEET 9 of 11  
MODEL AH-1G  
CHART DATE: See Sheet 1

**CENTER OF GRAVITY TABLE**

Moment/100

GROSS WEIGHT (POUNDS)	Approximate flight limits shown by heavy vertical line. Numbers in bold face are actual moment limits for weights indicated but not for stations shown in column head								
	190.0	191.0	192.0	194.0	196.0	198.0	200.0	201.0	201.3
9000		<b>17244</b>	17280	17460	17640	17820	18000	<b>18037</b>	
9025			17328	17509	17689	17870	18050		
9050		<b>17343</b>	17376	17557	17738	17919	18100	<b>18133</b>	
9075			17424	17606	17787	17969	18150		
9100		<b>17443</b>	17472	17655	17836	18018	18200	<b>18230</b>	
9125			17520	17703	17885	18068	18250		
9150		<b>17542</b>	17568	17751	17934	18117	18300	<b>18326</b>	
9175			17616	17800	17983	18167	18350		
9200		<b>17642</b>	17664	17848	18032	18216	18400	<b>18422</b>	
9225			17712	17897	18081	18266	18450		
9250		<b>17742</b>	17760	17945	18130	18315	18500	<b>18519</b>	
9275			17808	17994	18179	18365	18550		
9300		<b>17841</b>	17856	18042	18228	18414	18600	<b>18615</b>	
9325			17904	18091	18277	18464	18650		
9350		<b>17941</b>	17952	18139	18326	18513	18700	<b>18711</b>	
9375			18000	18188	18375	18563	18750		
9400		<b>18040</b>	18048	18236	18424	18612	18800	<b>18808</b>	
9425			18096	18285	18473	18662	18850		
9450		<b>18140</b>	18144	18333	18522	18711	18900	<b>18904</b>	
9475			18192	18382	18571	18761	18950		
9500			<b>18240</b>	18430	18620	18810	19000		

**GROSS WEIGHT LIMITATIONS:**

Takeoff \_\_\_\_\_ \*

Landing \_\_\_\_\_ \*

\*NOTE: Service activities shall insert, or substitute, current figures from latest applicable Technical Manual covering operating restrictions.

Figure 12-2. Chart E — loading data (Sheet 9 of 11)

Chart: E  
 Sheet: 10 of 11  
 Model: AH-1G  
 Chart Date: See Sheet 1

**MISCELLANEOUS DATA  
 PERSONNEL CENTROIDS**

COMPARTMENT	CREW MEMBER	ARM
A	Gunner	83.0
A	Pilot	135.0

**DIMENSIONAL DATA**

CONDITION	DIMENSION (INCHES)
Overall Length - Blades Extended or Rotating	635.7
Length - Blades Removed	535.1
Maximum Height - Tail Rotor Blades Vertical	165.5
Maximum Height - Blades Removed	147.3
Span - Blades Rotating	528.0
Span - Blades Removed	123.9

Figure 12-2. Chart E — loading data (Sheet 10 of 11)

Chart: E  
 Sheet: 11 of 11  
 Model: AH-1G  
 Chart Date: See Sheet 1

## TYPICAL SERVICE LOAD CONDITIONS

Item	Arm	Basic		Hog		Scout	
		Weight	Moment/100	Weight	Moment/100	Weight	Moment/100
Pilot	83.0	200	166	200	166	200	166
Gunner	135.0	200	270	200	270	200	270
Oil	234.1	23	54	23	54	23	54
Fuel		1625	3258	1040	2117	1495	3038
XM-157 Pods (2) O/B	201.8	103	208			103	208
XM-157 Rockets (14) O/B	194.7	302	589			302	589
Stores Pylon (2) O/B	198.1	40	79	40	79	40	79
Stores Pylon (2) I/B	194.4			68	133	68	133
XM-159 Pods (2) I/B	198.5			204	405		
XM-159 Pods (2) O/B	202.3			204	413		
XM-159 Rockets (38) I/B	190.9			821	1567		
XM-159 Rockets (38) O/B	194.7			821	1598		
Smoke Grenades - White (6)	255.0	11	27	11	27	11	27
Smoke Grenades - Colored (6)	265.0	6	16	6	16	6	16
7.62MM AMMO - 4000 Rounds	108.4	260	282	260	282	260	282
- 4000 Rounds	125.9	260	327			260	327
- 2000 Rounds	125.9			130	164		
XM-18 Minigun Pods (2)	196.4					490	962
XM-18 AMMO - 3000 Rounds	202.0					166	334
		3030	5276	4028	7291	3624	6485

Figure 12-2. Chart E — loading data (Sheet 11 of 11)

Section V — Weight and Balance Clearance Form F

**12-22. Weight and Balance Clearance Form F — DD Form 365F.** This form is a summary of actual disposition of the load in the helicopter. It records the balance status of the helicopter, step-by-step. It serves as work sheet on which the record weight and balance calculations, and any corrections that must be made to insure that the helicopter will be within weight and cg limits. A Form F is required only when the loading is such as to seriously effect the flying characteristics and safety of the helicopter and in all cases where alternate loading is employed.

**12-23. Use.** Form F is furnished in expendable pads, or as separate sheets, which can be replenished when exhausted. An original and carbon are prepared for each loading as applicable. The original sheets, carrying the signature of responsibility, can be removed and placed in the helicopter "G" files to serve as certificates of proper weight and balance as required by AR 95-16. The duplicate copy should be retained in the helicopter for the duration of the flight. On a cross country flight, this form aids the weight and balance technician at refueling bases and stopover stations. There are two versions of this form: "TRANSPORT" and "TACTICAL". These two versions were designed to provide for the respective loading arrangements of two type of helicopters. However, the general use of fulfillment of either version is the same. Specific instructions for filling out the "TACTICAL" is given in the following paragraphs.

**12-24. DD Form 365F—Tactical Helicopters.** Insert the necessary identifying information at the top of the form. In the blank spaces of the "Limitation" table, enter the gross weight and cg restrictions obtained from Chapter 7.

**Note**

Enter moment/constant values from Chart E throughout the form.

a. Reference 1 — Enter the helicopter basic weight and moment/constant (see figure 12-3). Obtain these figures from the last entry on Chart C — Basic Weight and Balance Record.

b. Reference 2 — Enter the amount and weight of oil.

c. Reference 3 — Using the compartment letter designations as shown on Chart E (helicopter diagram) enter the number and weight of the crew at their "take-off stations". Use actual crew weights if available.

d. Reference 4 — Enter the sum of the weights for reference 1 through reference 3 to obtain "Operating Weight".

e. Reference 5 — Enter by compartment the number of rounds, caliber and weight of all ammunition.

f. Reference 6 — Enter the size, distribution (forward, aft, external, etc.) and weight of all rockets, etc.

g. Reference 7 — Enter the number of gallons and weight of fuel.

h. Reference 8 — Not applicable.

i. Reference 9 — Not applicable.

j. Reference 10 — Enter the sum of the weights for reference 4 through reference 9 opposite "Take-Off Condition" (uncorrected). At this point, if not already done, calculate and enter the moment/constant for reference 1 through reference 10, inclusive.

k. Check the weight figure opposite reference 10 against the "Gross Weight Take-Off" in the "Limitations" table. Check the moment/constant figure opposite reference 10 by means of Chart E to ascertain that the indicated cg is within allowable limits.

l. Reference 11 — if changes in amount or distribution of load are required, indicate necessary adjustments by proper entries in the "Corrections" table in lower left-hand corner of the form as follows:

(1) Enter a brief description of the adjustment made in the column marked "Item".

(2) Add all the weight and moment decreases and insert the totals in the space opposite "Total Weight Removed"

(3) Add all the weight and moment increases and insert the totals in the space opposite "Total Weight Added"



WEIGHT AND BALANCE CLEARANCE FORM F TACTICAL (USE REVERSE FOR TRANSPORT MISSIONS)						FOR USE IN T. O. 1-1B-40 & AN 01-1B-40			
DATE <b>5-4-67</b>		AIRPLANE TYPE <b>AH-1G</b>		FROM		HOME STATION			
MISSION/TRIP/FLIGHT/NO. <b>SUPPORT</b>		SERIAL NO. <b>SAMPLE</b>		TO		PILOT			
REMARKS <b>* SEE CENTER OF GRAVITY TABLE "CHART E"</b>		REF	ITEM			WEIGHT		INDEX OR MOM	
		1	BASIC AIRPLANE (From Chart C)			5611		11469	
		2	OIL ( <b>3.0</b> Gal.)			23		54	
		3	DISTRIBUTION OF LOAD						
		COMPT.	CREW		BAGGAGE	CARGO AND MISC			
			NO.	WEIGHT					
		<b>A</b>	<b>1</b>	<b>190</b>	<b>PILOT</b>		<b>190</b>	<b>257</b>	
		<b>A</b>	<b>1</b>	<b>180</b>	<b>GUNNER</b>		<b>180</b>	<b>149</b>	
		COMPUTER PLATE NO. (If used)							
		Pertinent instructions to the pilot for shifting load and crew during takeoff and landing should be noted above.				4	OPERATING WEIGHT		<b>6004</b>
CORRECTIONS (Ref. 11)				5	COMPT.	ROUNDS	CALIBER		
COMPT.	ITEM	WEIGHT	INDEX OR MOM		<b>A</b>	<b>4000</b>		<b>260</b>	<b>282</b>
					<b>A</b>	<b>4000</b>		<b>260</b>	<b>327</b>
				6	FORWARD				
					AFT				
					EXTERNAL				
				7	ROCKETS				
					BUILT IN ( <b>240</b> Gal.)			<b>1560</b>	<b>3148</b>
					BOMB BAY ( Gal.)				
				8	EXTERNAL ( Gal.)				
					WATER INJ. FLUID ( Gal.)				
TOTAL WEIGHT REMOVED				9	JATO OR RATO				
TOTAL WEIGHT ADDED				10	TAKEOFF CONDITION (Uncorrected)			<b>8084</b>	<b>15686</b>
NET DIFFERENCE (Ref. 11)				11	CORRECTIONS (If required)				
				12	TAKEOFF CONDITION (Corrected)			<b>8084</b>	<b>15686</b>
				13	TAKEOFF C. G. IN % M. A. C. OR IN.			<b>194.0</b>	
LIMITATIONS				14	JATO OR RATO				
1 GROSS WT. TAKEOFF (lb.)		2 GROSS WT. LANDING (lb.)		LESS EXPENDABLES	BOMBS				
<b>9500</b>		<b>9500</b>			AMMUNITION			<b>520</b>	<b>609</b>
					FUEL <b>150 GAL.</b>			<b>975</b>	<b>1954</b>
3 PERMISSIBLE C. G. TAKEOFF		FROM *	TO (% M. A. C. or IN.)	15	ESTIMATED LANDING CONDITION			<b>6589</b>	<b>113123</b>
4 PERMISSIBLE C. G. LANDING		FROM *	TO (% M. A. C. or IN.)	16	ESTIMATED LANDING C. G. IN % M. A. C. OR IN.			<b>199.2</b>	
1 Enter constant used.				COMPUTED BY (Signature)					
2 Enter values from current applicable T. O.				WEIGHT AND BALANCE AUTHORITY (Signature)					
3 Applicable to gross weight (Ref. 12).				PILOT (Signature)					
4 Applicable to gross weight (Ref. 15).									

DD FORM 365F  
SEPT 54

209900-4B

Figure 12-3. Sample DD form 365F

(4) Subtract the smaller from the larger of the two totals and enter the difference (with applicable plus or minus sign) opposite "Net Difference".

(5) Transfer these net difference figures to the spaces opposite reference 11.

m. Reference 12 — Enter the sum of, or the difference between, reference 10 and reference 11. Recheck to ascertain that these figures do not exceed allowable limits.

n. Reference 13 — By referring to the cg table on Chart E determine the take-off cg possible. Enter this figure in the space provided opposite "Take-Off CG."

o. Reference 14 — Estimate the weight of ammunition (not including weight of cases and links if retained), fuel, and any other items which may be expended before landing. Enter figures together with moment/constant in the spaces provided.

p. Reference 15 — Enter the difference in weights and moment/constant between reference 12 and the total of reference 14.

q. Reference 16 — By again referring to the cg table on Chart E, determine the estimated landing cg position. Enter the figure opposite "Estimated Landing CG."

**Note**

Do not consider reserve fuel, as expended when determining "Estimated Landing Condition."

Check the landing cg figure with permissible cg figures in limitations block. The landing cg must be within the range of the figures shown.

r. The necessary signatures must appear at the bottom of the form.

## CHAPTER 13

### AIRCRAFT LOADING

#### Section I — Scope

**13-1. Scope.** All essential information for ammunition loading is contained in this Chapter.

**13-2.** This Chapter outlines the different mission configurations.

#### Section II — Introduction

**13-3. Introduction.** The purpose of this chapter is to provide complete information and instructions to accomplish safe loading of the helicopter for the numerous types of missions the helicopter can reasonably be expected to perform.

**13-4.** A typical loading example is also given and can be used as a guide when loading calculations need to be computed.

**13-5. Armament Loading.** A typical load for a Basic Mission, Hog Mission and Scout Mission is shown on figure 13-1.

## TYPICAL SERVICE LOADING

ITEM	ARM	Basic		Hog		Scout	
		Weight	Moment/100	Weight	Moment/100	Weight	Moment/100
Pilot	83.0	200	166	200	166	200	166
Gunner	135.0	200	270	200	270	200	270
Oil	234.1	23	54	23	54	23	54
Fuel		1625	3258	1040	2117	1495	3038
XM-157 Pods (2) O/B	201.8	103	208			103	208
XM-157 Rockets (14) O/B	194.7	302	589			302	589
Stores Pylon (2) O/B	198.1	40	79	40	79	40	79
Stores Pylon (2) I/B	194.4			68	133	68	133
XM-159 Pods (2) I/B	198.5			204	405		
XM-159 Pods (2) O/B	202.3			204	413		
XM-159 Rockets (38) I/B	190.9			821	1567		
XM-159 Rockets (38) O/B	194.7			821	1598		
Smoke Grenades - White (6)	255.0	11	27	11	27	11	27
Smoke Grenades - Colored (6)	265.0	6	16	6	16	6	16
7.62mm Ammo - 4000 Rounds	108.4	260	282	260	282	260	282
7.62mm Ammo - 4000 Rounds	125.9	260	327			260	327
7.62mm Ammo - 2000 Rounds	125.9			130	164		
XM-18 Minigun Pods (2)	196.4					490	962
XM-18 Ammo - 3000 Rounds	202.0					166	334
<b>Totals</b>		<b>3030</b>	<b>5276</b>	<b>4028</b>	<b>7291</b>	<b>3624</b>	<b>6485</b>

Figure 13-1. Service loading

## CHAPTER 14

### PERFORMANCE DATA

#### Section I — Scope

**14-1. Purpose.** The charts contained in this chapter reflect the necessary data required for pre-flight and in-flight mission planning. The necessary explanatory text for use of the data presented is also contained herein.

**14-2.** The performance charts are presented in tabular, graphic or profile form. Charts are based on flight test data, calculated data or estimated data as indicated on the chart.

#### Section II — Instructions For Chart Use

**14-3. Density Altitude Chart.** Density Altitude is an expression of the density of the air in terms of height above sea level; hence, the less dense the air the higher the density altitude. For standard conditions of temperature and pressure, density altitude is the same as pressure altitude. As temperature increases above standard for any altitude, the density altitude will also increase to values higher than pressure altitude. A high density altitude affects the performance of both the main rotor and the engine. When density altitude is high, less lift is developed by the rotor blades for any given power setting other than at standard conditions. See figure 14-1 which expresses density altitude and temperature. An example of the use of the chart is contained in the chart.

**14-4. Standard Atmospheric Table.** The standard atmospheric table (see figure 14-2) depicts the Standard Sea Level conditions at the top left side of the chart and Conversion Factors at the top right side. The altitude in feet, 0 to 40,000 is carried in the left vertical column of the chart. The remaining seven columns depicts the data that is generally required.

**14-5. Airspeed Installation Correction Table.** An airspeed installation chart (see figure 14-3) is provided to supply the correction required to determine calibrated airspeed (CAS). Indicated airspeed (IAS) as read from the instrument and corrected for instrument error, plus or minus installation correction, equals calibrated airspeed (CAS). Because of the speed range at

which the helicopters operate, compressibility correction is negligible; therefore, it has been intentionally omitted. An approximate true airspeed (TAS) for a standard day can be obtained from CAS by adding one and one-half percent of CAS per 1000 feet density altitude to CAS.

**14-6. Engine Operating Limits.** Maximum power available for the T53-L-13 engine is given in figure 14-4. These powers are based on the engine manufacturer's specifications and guarantees. Corrections based on flight test are included for installation losses of the engine in the helicopter.

**14-7.** Performance data given in this manual are based on an engine which can produce specification or rated power. Ordinarily, the engines installed in the helicopters are capable of producing more than these powers; therefore, unless engine deterioration has occurred, adequate power should be available, and loadings and ceilings given in this manual should be realized. In the event that deterioration in engine output is suspected, the curves in figure 14-4 may be used to make a rough comparison of actual and rated engine performance using the flight instruments available to the pilot. To make the comparison, mentally record pressure altitude and OAT and at the same time apply full power. Now note the torquemeter reading. Enter the curves at the recorded pressure altitude and temperature, and read torque pressure available. The torquemeter reading attained in flight should be at least as great as that shown on the curve. It is emphasized that such comparisons are approximate, and they can result in low engine power indications. This is

due to several factors: (1) the high rate of climb when full power is applied, which in turn results in rapidly changing air pressure and temperatures; (2) manufacturing tolerances in the torquemeter and flight instruments; (3) readability of flight instruments and (4) pilot techniques. In addition, two precautions should be observed by the pilot when making the flight check; (1) Avoid hovering with full power in ground effect except for take-off and transition due to the decrease in power caused by an engine inlet temperature rise when in ground effect; (2) on some helicopters, more torque may be obtained if engine rpm is allowed to drop below 6600 to 6550 when full power is applied, due to the droop characteristics of the engine.

**14-8.** If the engine does not appear to be producing specification power and torque, allowable hovering ceilings or loads as given in this manual will be decreased. Conservative rules of thumb in this event are to reduce gross weight 200 pounds for each psi of deficient torque or reduce hovering ceiling 1000 feet for each psi of deficient torque. These increments may be subtracted directly from the maximum take-off gross weights and ceilings, which the pilots determine from the curves and tables given elsewhere, in the manual. The curves and tables are entered normally at the actual or anticipated air temperatures and pressure altitudes of the flight, then the increments in gross weight or altitude are subtracted.

**14-9. Go-No-Go Take-Off Data — For Departure From Confined Area.** The data that is provided on the Go-No-Go decal provides a ready reference as to the power that the engine is capable of producing in reference to nI. A climb out from a confined area requires an additional two percent nI more than the power required to hover at two feet. The Go-No-Go decal, located adjacent to the nI tachometer, provides the two foot hovering nI reading for four different temperatures (15°C, 25°C, 35°C and 40°C). The decal shall be filled out as specified on figure 14-5. The readings on the decal provide the percent nI that the helicopter requires to hover at two foot skid height in order to take-off from a confined area. A take-off should not be attempted if the helicopter is unable to hover at a two foot skid height at the percent nI and accompanying temperature as shown on the Go-No-Go decal. The temperature bias effect has been accounted for in the initial filling of the blank spaces of the decal.

**14-10. Maximum Gross Weight for Vertical Take-Off.** The Maximum Gross Weight for Vertical Take-Off Charts (see figure 14-6), presents the maximum gross weight for hovering out of ground effect and vertical climb as limited by the vertical climb performance of the helicopter. The charts are provided for both a 2°C inlet and 5°C inlet temperature rise. The chart is based on the ability of the aircraft to hover out of ground effect and climb vertically using military power.

**Example:** It is desired to have a vertical rate of climb of 200 fpm. Find maximum take-off gross weight. Pressure altitude is 5000 feet, OAT is 15°C and head wind is 15 knots.

a. Enter the chart (see figure 14-6, sheet 2) at 5000 feet pressure altitude and move horizontally to the right to intersect the 15°C OAT curve.

b. Move down vertically to the lower chart. Follow the flow curve to the 15 knot wind line. Drop vertically from the 15 knot point to the 0 line of the vertical R/C chart section. Follow the flow curve to the 200 vertical R/C point. Drop vertically to the gross weight scale and read 8700 pounds. Under the same conditions of atmosphere, the gross weight limitations can be increased by reducing the rate of climb.

**14-11. Hovering Chart (In Ground Effect).** The Hovering Charts (see figure 14-7) provide information to determine the maximum gross weights at which the helicopter can hover. These charts supplement the take-off distance charts. The charts provided for each condition are for operation at 6600 rpm. The AH-1G is not rotor stall limited at any of the conditions shown on the charts.

**Note**

The hovering out of ground effect charts are combined into the Maximum Gross Weight for Vertical Take-Off charts (see figure 14-6).

**14-12.** Charts for hovering in-ground effect are shown for military power and normal power. For short periods of hovering in-ground effect (less than one minute) the 2°C temperature rise chart should be used. For longer periods the 5°C temperature chart should be used since

the inlet temperature rises due to recirculation of air into the engine.

**14-13.** The known conditions necessary to use the in-ground effect chart are: Power (military or normal), pressure altitude and temperature. The chart contains one graph which is used to determine the operating capabilities of the helicopter.

**14-14.** The following problem and example are for use with the Hovering In-Ground Effect Chart with Military Power; however, the procedure to obtain the gross weight operating limits is applicable for all Hovering In-Ground Effect charts.

**Problem:**

Pressure altitude	7000 feet
Temperature	15°C
Inlet temperature rise	2°C

**Example:** Enter the chart (Hovering In-Ground Effect — Military Power) at 7000 feet altitude and move right to intersect the 15°C temperature curve. From this point drop vertically to the Gross Weight scale and read 9400 pounds maximum hovering weight for the existing conditions.

**14-15. Vertical Rate of Climb Chart.** The Vertical Rate of Climb Chart (see figure 14-8) provides information to determine the vertical rate of climb for various pressure altitudes and gross weights. The chart is for military power and standard day conditions.

**14-16.** The following problem and example are for use with the Vertical Rate of Climb chart. Find maximum vertical rate of climb.

**Problem:**

Standard day	
Pressure altitude	4000 feet
Gross weight	6500 pounds

**Example:** Enter chart at 4000 feet pressure altitude and move to the right to intersect the 6500 pound gross weight curve. From this point drop vertically to the vertical rate of climb scale and read 2200 feet. The 2200 feet is the maximum vertical rate of climb for the above stated condition.

**14-17. Take-Off Distance Chart.** The Take-Off Distance Chart (see figure 14-9) lists minimum take-off distances for various pressure altitudes, air temperatures and gross weights.

Take-off distances are given for maximum performance take-off procedures only, as distinguished from normal take-off procedures described in Chapter 3. Maximum performance take-offs result in the minimum take-off distance.

**14-18.** The first set gives take-off distances utilizing the maximum performance hover and level acceleration technique. Engine speed is maintained at 6600 rpm. If the helicopter can hover out of ground effect, take-off distances and climb-out airspeeds are given as zero. This procedure requires a vertical lift-off and a vertical climb to an altitude above the obstacle before accelerating into forward flight. If the take-off distance is greater than zero, this means the helicopter cannot hover out of ground effect. In these cases, the helicopter takes off vertically to a skid height of two feet above the ground, accelerates at two feet, to the climb-out airspeed given in the charts, and climbs over the obstacle at that airspeed. If the climb-out airspeed is greater or less than the value given in the chart, take-off distances will be increased. If the skid height is greater than two feet prior to obtaining climb-out airspeed, the take-off distances will be greater. If the helicopter cannot hover two feet off the ground, no take-off distances are shown and the gross weight should be decreased if this technique is to be used.

**Note**

When the take-off distance is zero, the climb-out airspeed is also zero (vertical climb is possible). The climb-out airspeed is given adjacent to each take-off distance.

**14-19.** The second technique involves hovering with the helicopter light on skids and then increasing airspeed and altitude simultaneously. Engine speed is maintained at 6600 rpm. If the helicopter can hover out of ground effect, take-off distances and climb-out airspeed are given as zero. This procedure requires a vertical lift-off and a vertical climb to an altitude above the obstacle before accelerating into forward flight. If the take-off distance is greater than zero, this means the helicopter cannot hover out of ground effect. In these cases, the helicopter is brought to a hover light on skids. As power is applied and the helicopter leaves the ground, hold constant pitch attitude until airspeed starts to register. When this occurs, fine pitch attitude adjustments will be necessary to obtain

the desired airspeed. Once airborne, the pilot should allow airspeed and altitude to increase simultaneously until the obstacle is cleared. The airspeed and altitude should then be increased as soon as possible to avoid operation in the restricted area of the height-velocity diagram. If the climb-out is greater or less than the value given in the chart, take-off distances will be increased. If the helicopter cannot hover light on skids, no take-off distances are shown and the gross weight should be decreased if this technique is to be used.

**14-20.** When take-off distances are greater than zero, the take-off procedure is as follows: Apply sufficient power at 6600 engine rpm to maintain aircraft light on skids. Increase collective pitch to lift the helicopter off the ground and apply forward cyclic control to start forward movement of the aircraft. Accelerate into forward flight, allowing the engine speed to decrease to a minimum of 6400 rpm. When translational lift is attained, increase collective pitch to decrease engine speed to a minimum of 6000. Just prior to obtaining climb-out airspeed given in the chart rotate the aircraft nose up and climb at that airspeed, maintaining 6000 engine rpm. When clear of obstacle, reduce pitch slightly to regain 6600 engine rpm. If the climb-out airspeed is greater or less than the chart value, take-off distance will be increased. If the helicopter has insufficient power to hover light on the skids, no take-off distances are shown and gross weight should be decreased.

**Caution**

The nII droop should be used only where mission requirements are such as to dictate that the take-off under existing conditions must be made. Care must be exercised not to droop nII speed below 6000 rpm as a net loss in lift will then result. Pilot experience level must be considered in the use of this procedure.

**14-21. Climb Chart.** The Climb Chart (see figure 14-10) data includes rate of climb, torque pressure, distance, time and fuel used to climb to altitude. The figures stated are for normal power performance, based upon the use of optimum climbing speed schedules shown. Use of climbing speeds other than shown on the climb chart will result in a reduced rate of climb and increased fuel and time consumed at all altitudes. On warm days, rates of climb will be less than the chart values.

**Example:** Determine the time to climb to 6000 feet and the fuel used for a gross weight of 6500 pounds. At the top of figure 14-10, sheet 1 find 6500 pound section and in the center column find 6000 feet altitude. By reading horizontally to the right at this altitude the following are obtained.

- a. Best climbing speed — 58 IAS knots.
- b. Fuel consumed — 24 pounds.

**Note**

The 24 pounds does not include the 24 pounds used for warm-up.

- c. Time required for climb — 2.1 minutes.
- d. Distance traveled — 1.8 nautical miles.
- e. Rate of climb — 2873 feet per minute.

**14-22. Range Chart.** The Range Chart (see figure 14-11 basic, 14-12 scout and 14-13 hog configuration) shows the range capabilities for various power conditions and fuel allowance. These charts may be used for inflight and pre-flight planning. The initial conditions are gross weight, actual pressure altitude of the helicopter and fuel quantity.

**14-23.** The Basic Configuration of the helicopter carries TAT-102A or XM-28 turret plus two XM-157 rocket pods. The Scout Configuration carries TAT-102A or XM-28 turret, two XM-157 rocket pods and two XM-18 automatic guns. The Hog Configuration carries TAT-102A or XM-28 turret plus four XM-159 rocket pods.

**14-24.** The chart is divided into four main sections, gross weight, pressure altitude, power settings and range in nautical miles for various fuel quantities. Fuel allowances must be made for various contingencies such as take-off, climb, wind and landing conditions. All data in the range chart is for standard day conditions (i.e. 15°C at sea level). On days when free air temperature is other than standard, range performances will be slightly different from values given.

**14-25.** To use the range chart, refer to the chart for the appropriate cruise condition. Enter the chart at gross weight and altitude, read the approximate fuel consumption and airspeed. Read range under the fuel quantity for the desired flight condition. At any time before or



during the flight, the pilot may refer to the chart with actual conditions of weight, altitude and fuel to obtain range remaining.

**Example:** The helicopter is to fly at 4000 feet altitude with take-off gross weight of 6000 pounds.

a. It is desired to have 80 pounds of fuel in reserve and from the climb chart (see figure 14-10) it is found that approximately 46 pounds of fuel is required for warm-up and climb to 4000 feet altitude from sea level. Adding 80 pounds reserve and 46 pounds for climb and subtracting the total from the total fuel load of 930 pounds gives a fuel balance for cruise of 804 pounds.

b. Enter the range chart (see figure 14-11, Long Range—Maximum Speed) at 6000 pounds and 4000 feet altitude and a fuel quantity of 800 pounds.

c. Read 186 nautical miles range in a no wind condition.

**14-26. Maximum Endurance Chart.** The maximum endurance chart (see figure 14-14) shows the maximum available flight with various gross weight conditions at sea level and at altitudes. All data in the chart is for standard day conditions (i.e., 15°C at sea level).

**Example:** The helicopter is to fly at 2000 feet altitude with a take-off gross weight of 6000 pounds and a fuel load of 920 pounds. It is desired to have 80 pounds of fuel in reserve from the climb chart (see figure 14-10), it is found that 32 pounds of fuel is required for warm-up and climb to 2000 feet altitude from sea level. Subtracting the desired fuel reserve and fuel required for climb from total fuel load gives a fuel balance for cruise of 808 pounds.

**14-27.** Enter the maximum endurance chart (sheet 1) at 6000 pounds gross weight, 2000 feet pressure altitude and a fuel quantity of 800 pounds, read a maximum endurance of 2.0 hours. The fuel consumption is 406 pounds per hour, torque pressure 15.8 psig and a IAS of 55 knots.

**14-28. Hovering Endurance Chart.** The hovering endurance chart (see figure 14-15) shows the maximum endurance possible while hovering with various gross weight conditions

at sea level and at altitude. All chart data is for standard day conditions; therefore, when the free air temperature is other than standard (i.e., 15°C at sea level) hovering endurance performance will be slightly different from that shown on the chart.

**Example:** The helicopter is to hover at 2000 feet altitude with a take-off gross weight of 6000 pounds with an allotted 600 pounds of fuel to be used. Enter the hovering endurance chart at 6000 pounds gross weight, 2000 feet pressure altitude and a fuel quantity of 600 pounds. Read hovering endurance of 1.1 hours with an engine torque pressure of 30.2 psig. Under these conditions, the engine will be using 540 pounds of fuel an hour.

**14-29. Landing Distance Chart.** Two landing distance charts are furnished (figure 14-16, Landing Distance—Power ON Chart and figure 14-17, Landing Distance Power Off Chart). Both sets of charts give minimum possible landing distances. The power-on chart (see figure 14-16) shows minimum landing distances over a 50 foot obstacle with power on. The landing distances are less than those required if the normal operating procedures in Chapter 3 are followed. Whenever the helicopter can hover out-of-ground effect, landing distances are given as zero. Corresponding approach speeds over the 50 foot obstacle are also zero. When the helicopter can hover in-ground effect, landing distance will be other than zero. When the helicopter cannot hover in-ground effect, a ground run distance is included in the distance to clear a 50 foot obstacle. A note is added to the power-on charts that a safer, more normal approach and landing will result if the power off landing distance in figure 14-17 are used. The power-off chart shows helicopter requirements where autorotational landing technique is used as recommended in Chapter 4. Both charts list landing distances for various pressure altitudes, air temperatures and gross weights. Greater landing distances are required at higher altitudes, on warm, humid days and for heavier gross weights.

**Example:** Power-On landing gross weight 6000 pounds, pressure altitude 12,000 feet and outside air temperature 35°C (59°F). Select 6000 pounds gross weight, 12,000 feet altitude and move horizontally across chart to the 35°C temperature column. Note that the best approach speed is 25 knots and 104 feet distance is necessary after clearing 50 foot obstacle.

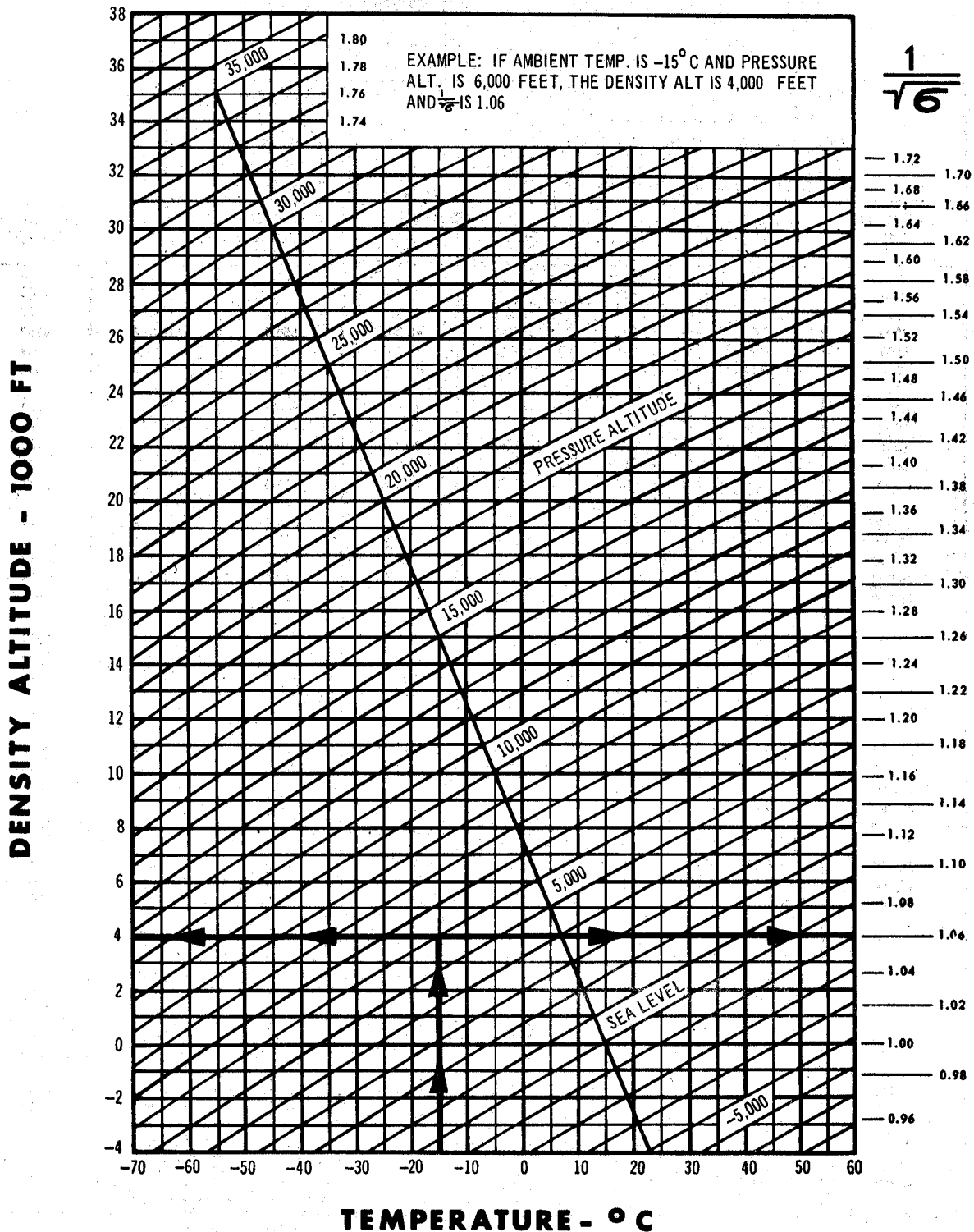

Figure 14-1. Density altitude chart

TEMPERATURE CONVERSION CHART

Look up reading in middle column; if in degrees Centigrade, read Fahrenheit equivalent in right-hand column; if in degrees Fahrenheit, read Centigrade equivalent in left-hand column.

C	F	C	F	C	F	C	F
-54	- 65	- 85	28.9	84	183.2	266	510
-51	- 60	- 76	30.0	86	186.8	271	520
-46	- 50	- 58	31.1	88	190.4	277	530
-40	- 40	- 40	32.2	90	194.0	282	540
-34	- 30	- 22	33.3	92	197.6	288	550
-29	- 20	- 4	34.4	94	201.2	293	560
-23	- 10	14	35.6	96	204.8	299	570
-17.8	0	32	36.7	98	208.4	304	580
-16.7	2	35.6	37.8	100	212.0	310	590
-15.6	4	39.2	43	110	230	316	600
-14.4	6	42.8	49	120	248	321	610
-13.3	8	46.4	54	130	266	327	620
-12.2	10	50.0	60	140	284	332	630
-11.1	12	53.6	66	150	302	338	640
-10.0	14	57.2	71	160	320	343	650
- 8.9	16	60.8	77	170	338	349	660
- 7.8	18	64.4	82	180	356	354	670
- 6.7	20	68.0	88	190	374	360	680
- 5.6	22	71.6	93	200	392	366	690
- 4.4	24	75.2	99	210	410	371	700
- 3.3	26	78.8	104	220	428	377	710
- 2.3	28	82.4	110	230	446	382	720
- 1.1	30	86.0	116	240	464	388	730
0.0	32	89.6	121	250	482	393	740
1.1	34	93.2	127	260	500	399	750
2.2	36	96.8	132	270	518	404	760
3.3	38	100.4	138	280	536	410	770
4.4	40	104.0	143	290	554	416	780
5.6	42	107.6	149	300	572	421	790
6.7	44	111.2	154	310	590	427	800
7.8	46	114.8	160	320	608	432	810
8.9	48	118.4	166	330	626	438	820
10.0	50	122.0	171	340	644	443	830
11.1	52	125.6	177	350	662	449	840
12.2	54	129.2	182	360	680	454	850
13.3	56	132.8	188	370	698	460	860
14.4	58	136.4	193	380	716	466	870
15.6	60	140.0	199	390	734	471	880
16.7	62	143.6	204	400	752	477	890
17.8	64	147.2	210	410	770	482	900
18.9	66	150.8	216	420	788	488	910
20.0	68	154.4	221	430	806	493	920
21.1	70	158.0	227	440	824	499	930
22.2	72	161.6	232	450	842	504	940
23.3	74	165.2	238	460	860	510	950
24.4	76	168.8	243	470	878	516	960
25.6	78	172.4	249	480	896	521	970
26.7	80	176.0	254	490	914	527	980
27.8	82	179.6	260	500	932	532	990

Figure 14-1A. Temperature conversion table

**STANDARD ATMOSPHERE TABLE**

STANDARD S I CONDITIONS:					CONVERSION FACTORS:		
TEMPERATURE 15°C (59°F)					1 IN. Hg 70.727 LB/SQ FT		
PRESSURE 29.921 IN. Hg 2116.216 LB/SQ FT					1 IN. Hg 0.49116 LB/SQ IN.		
DENSITY .0023769 SLUGS/CU FT					1 KNOT 1.151 M.P.H.		
SPEED OF SOUND 1116.89 FT/SEC 661.7 KNOTS					1 KNOT 1.688 FT/SEC		
ALTITUDE FEET	DENSITY RATIO $\sigma$	$\sigma - 1/2$ $\frac{1}{\sqrt{\sigma}}$	TEMPERATURE		SPEED OF SOUND KNOTS	PRESSURE IN. Hg	PRESSURE RATIO $\delta$
			°C	°F			
0	1.000	1.0000	15.000	59.000	661.7	29.921	1.0000
1000	.9711	1.0148	13.019	55.434	659.5	28.856	.9644
2000	.9428	1.0299	11.038	51.868	657.2	27.821	.9298
3000	.9151	1.0454	9.056	48.302	654.9	26.817	.8962
4000	.8881	1.0611	7.076	44.735	652.6	25.842	.8637
5000	.8617	1.0773	5.094	41.169	650.3	24.896	.8320
6000	.8359	1.0938	3.113	37.603	648.7	23.978	.8014
7000	.8106	1.1107	1.132	34.037	645.6	23.088	.7716
8000	.7860	1.1279	-0.850	30.471	643.3	22.225	.7428
9000	.7620	1.1456	-2.831	26.905	640.9	21.388	.7148
10,000	.7385	1.1637	-4.812	23.338	638.6	20.577	.6877
11,000	.7155	1.1822	-6.793	19.772	636.2	19.791	.6614
12,000	.6932	1.2011	-8.774	16.206	633.9	19.029	.6360
13,000	.6713	1.2205	-10.756	12.640	631.5	18.292	.6113
14,000	.6500	1.2403	-12.737	9.074	629.0	17.577	.5875
15,000	.6292	1.2606	-14.718	5.508	626.6	16.886	.5643
16,000	.6090	1.2815	-16.699	1.941	624.2	16.216	.5420
17,000	.5892	1.3028	-18.680	-1.625	621.8	15.569	.5203
18,000	.5699	1.3246	-20.662	-5.191	619.4	14.942	.4992
19,000	.5511	1.3470	-22.643	-8.757	617.0	14.336	.4791
20,000	.5328	1.3700	-24.624	-12.323	614.6	13.750	.4595
21,000	.5150	1.3935	-26.605	-15.889	612.1	13.184	.4406
22,000	.4976	1.4176	-28.587	-19.456	609.6	12.636	.4223
23,000	.4806	1.4424	-30.568	-23.022	607.1	12.107	.4046
24,000	.4642	1.4678	-32.549	-26.588	604.6	11.597	.3876
25,000	.4481	1.4938	-34.530	-30.154	602.1	11.103	.3711
26,000	.4325	1.5206	-36.511	-33.720	599.6	10.627	.3552
27,000	.4173	1.5480	-38.492	-37.286	597.1	10.168	.3398
28,000	.4025	1.5762	-40.474	-40.852	594.6	9.725	.3250
29,000	.3881	1.6052	-42.455	-44.419	592.1	9.297	.3107
30,000	.3741	1.6349	-44.436	-47.985	589.5	8.885	.2970
31,000	.3605	1.6654	-46.417	-51.551	586.9	8.488	.2837
32,000	.3473	1.6968	-48.398	-55.117	584.4	8.106	.2709
33,000	.3345	1.7291	-50.379	-58.683	581.8	7.737	.2586
34,000	.3220	1.7623	-52.361	-62.249	579.2	7.382	.2467
35,000	.3099	1.7964	-54.342	-65.816	576.6	7.041	.2353
36,000	.2981	1.8315	-56.323	-69.382	574.0	6.712	.2243
36,089	.2971	1.8347	-56.500	-69.700	573.7	6.683	.2234
37,000	.2843	1.8753				6.397	.2138
38,000	.2710	1.9209				6.097	.2038
39,000	.2583	1.9677				5.811	.1942
40,000	.2462	2.0155				5.538	.1851

Figure 14-2. Standard atmospheric table

# AIRSPEED INSTALLATION CORRECTION TABLE

Model(s): AH-1G  
Data as of: JULY 1, 1966  
DATA BASIS: FLIGHT TEST

Engine(s): Lycoming T53-L-11/13  
Fuel Grade: JP-4  
Fuel Density: 6.5 LB/GAL.

Indicated Airspeed (IAS)-Kts	Airspeed Correction --Kts	Calibrated Airspeed (CAS)-Kts
10	-4.5	5.5
20	-3.9	16.1
30	-3.1	26.9
40	-2.3	37.7
50	-1.3	48.7
60	-0.3	59.7
70	+0.3	70.3
80	+0.6	80.6
90	+0.3	90.3
100	-0.4	99.6
110	+1.3	108.7
120	-2.3	117.7
130	-3.2	126.8
140	-3.9	136.1
150	-4.4	145.6
160	-4.8	155.2
170	-4.8	165.2
180	-4.5	175.5
190	-3.9	186.1
200	-3.0	197.0

Add Correction To Indicated Airspeed  
To Obtain Calibrated Airspeed

Figure 14-3. Airspeed installation correction table

# ENGINE OPERATING LIMITS

NORMAL POWER AVAILABLE  
2°C INLET TEMPERATURE RISE

ARMY MODEL AH-1G  
DATA AS OF: AUGUST 1966  
DATA BASIS: CALCULATED, Lycoming Engine  
Spec. No. 104.33 (Engine Installed)

ENGINES: Lycoming T53-L-13  
ENGINE SPEED: 6600 RPM  
FUEL GRADE: JP-4  
FUEL DENSITY: 6.5 LB/GAL.

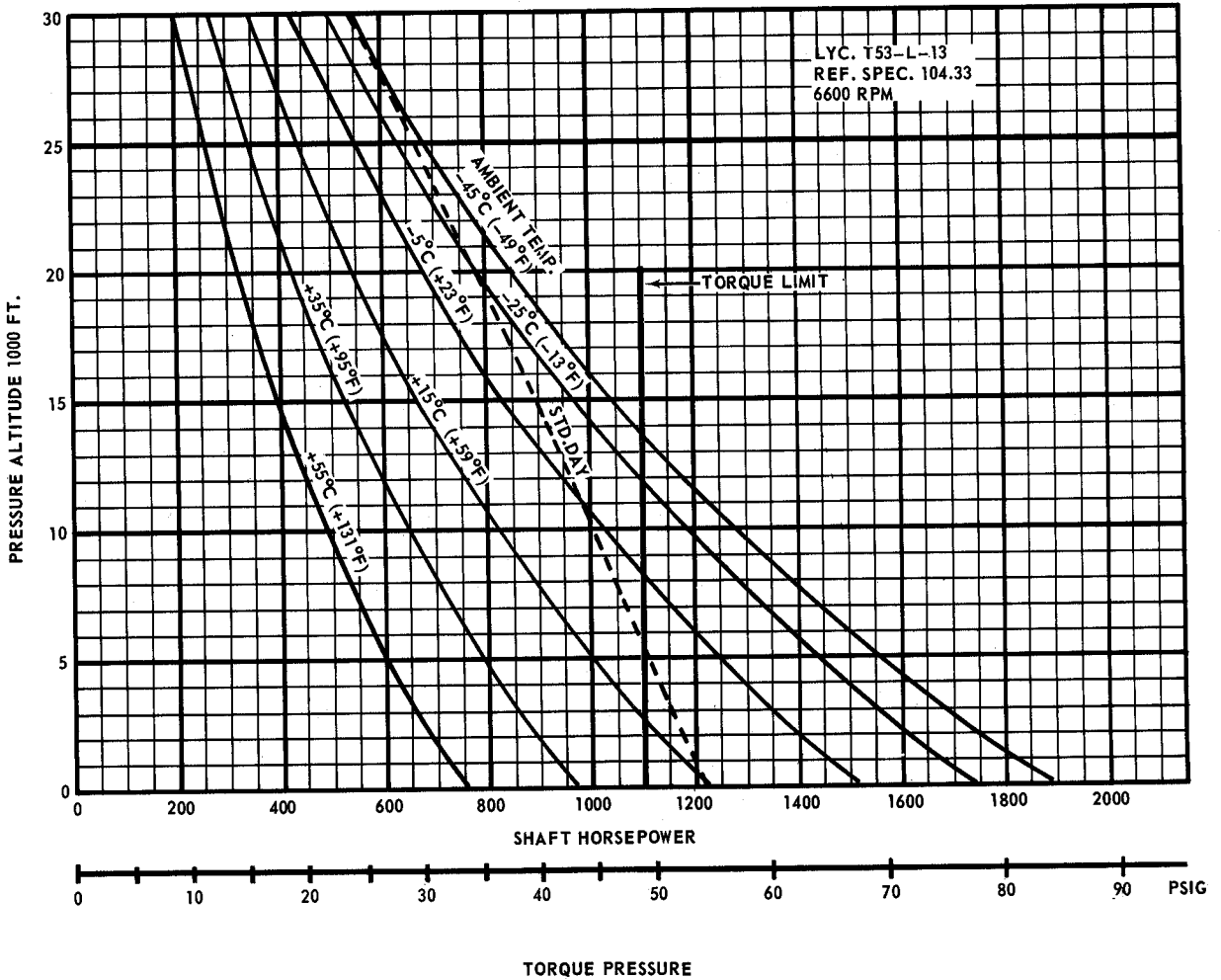

REMARKS:

Figure 14-4. Engine operating limits (Sheet 1 of 6)

13

# ENGINE OPERATING LIMITS

13

MILITARY POWER AVAILABLE  
2°C INLET TEMPERATURE RISE

ARMY MODEL: AH-1G  
DATA AS OF: AUGUST 1966  
DATA BASIS: CALCULATED, Lycoming Engine  
Spec. No. 104.33 (Engine Installed)

ENGINES: Lycoming T53-L-13  
ENGINE SPEED: 6600 RPM  
FUEL GRADE JP-4  
FUEL DENSITY: 6.5 LB/GAL.

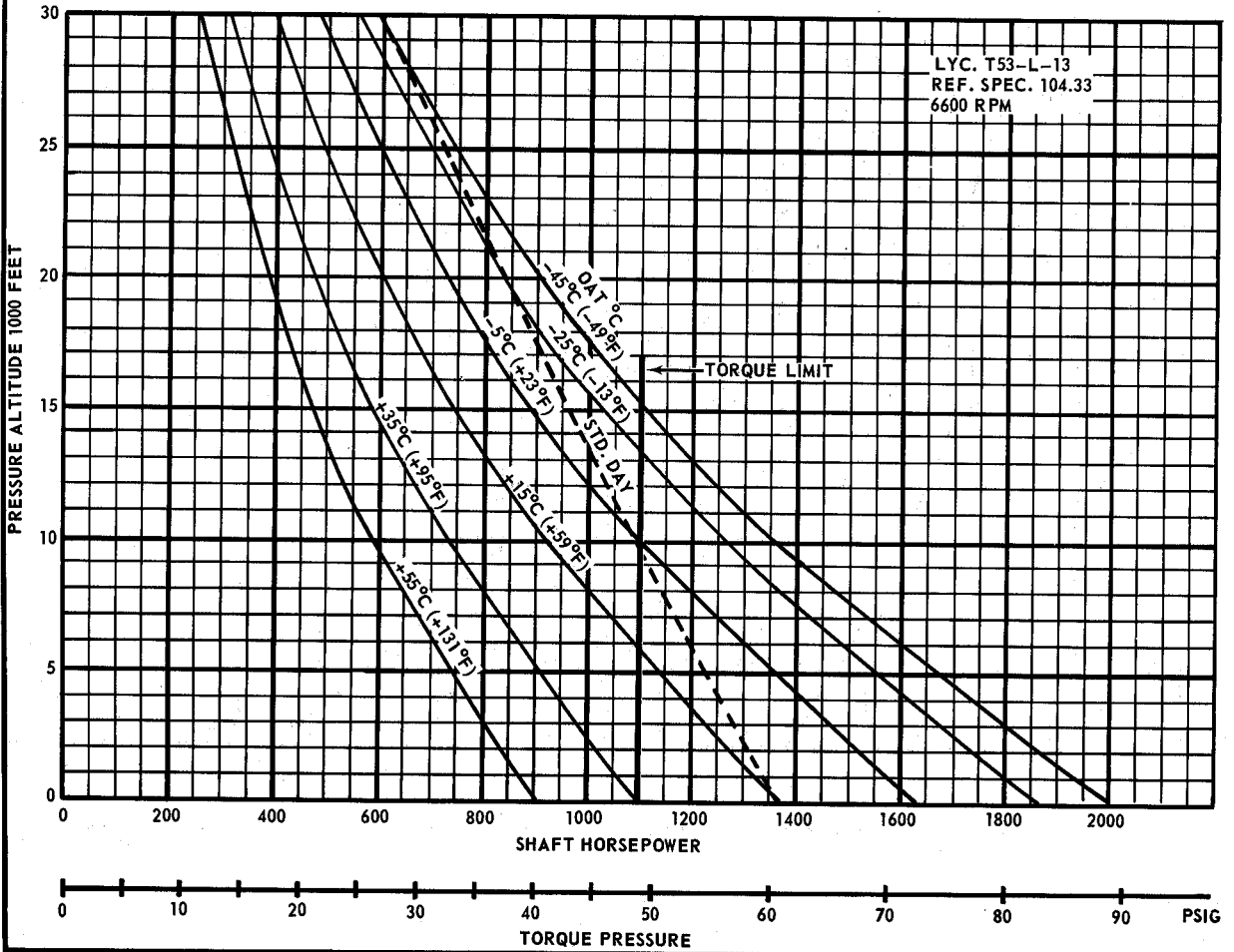

REMARKS:

Figure 14-4. Engine operating limits (Sheet 2 of 6)

# ENGINE OPERATING LIMITS

NORMAL POWER AVAILABLE  
2°C INLET TEMPERATURE RISE

ARMY MODEL(S): AH-1G  
 DATA AS OF: SEPTEMBER 1962  
 DATA BASIS: CALCULATED FROM FTC-TDR-62-21 "YUH-1B  
 CATEGORY II PERFORMANCE TESTS" AND LYCOMING ENGINE  
 SPECIFICATION NO. 104.28

ENGINES: T53-L-11  
 ENGINE RPM: 6600  
 FUEL GRADE: JP-4  
 FUEL DENSITY: 6.5 LBS/GAL.

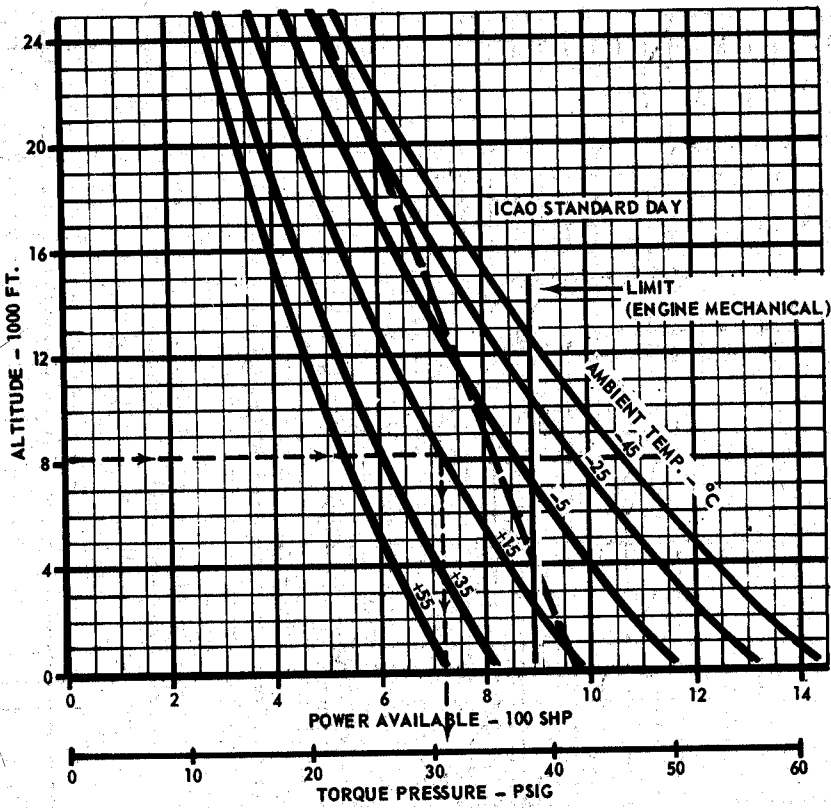

REMARKS:

Figure 14-4. Engine operating limits (Sheet 3 of 6)



# ENGINE OPERATING LIMITS

MILITARY POWER AVAILABLE  
2°C INLET TEMPERATURE RISE

ARMY MODEL(S): AH-1G  
DATA AS OF: SEPTEMBER 1962  
DATA BASIS: CALCULATED FROM FTC-TDR-62-21 "YUH-1B  
CATAGORY II PERFORMANCE TESTS" AND LYCOMING ENGINE  
SPECIFICATION NO. 104.28

ENGINES: T53-L-11  
ENGINE RPM: 6600  
FUEL GRADE: JP-4  
FUEL DENSITY: 6.5 LBS/GAL.

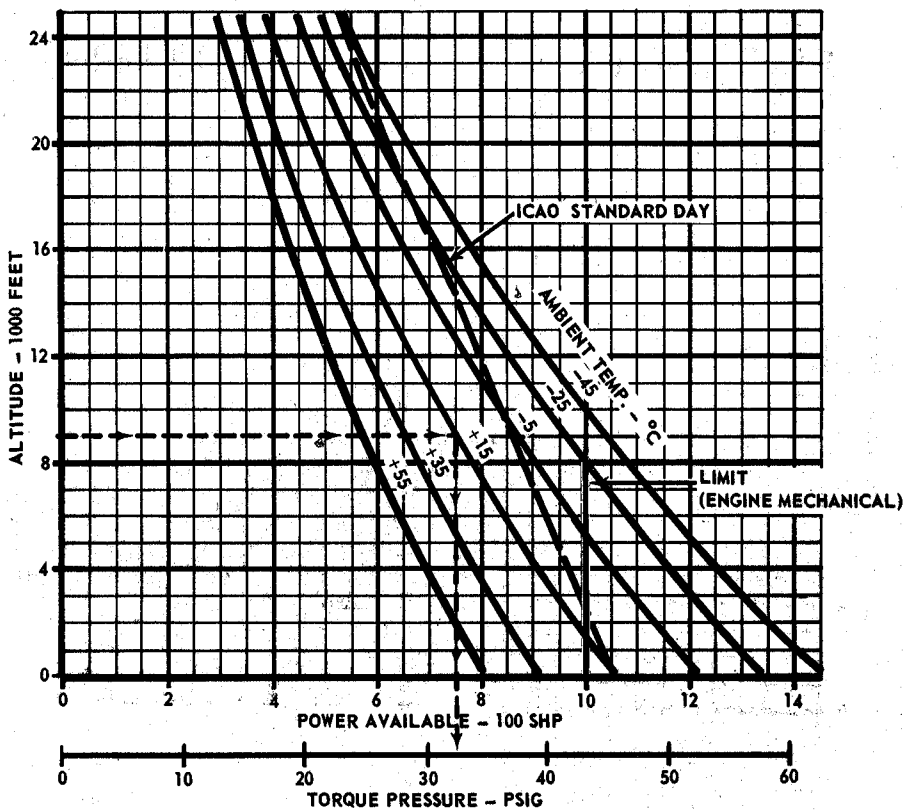

REMARKS:

Figure 14-4. Engine operating limits (Sheet 4 of 6)

# ENGINE OPERATING LIMITS

TAKE-OFF POWER AVAILABLE  
2°C INLET TEMPERATURE RISE

ARMY MODEL(S): AH-1G  
 DATA AS OF: SEPTEMBER 1962  
 DATA BASIS: CALCULATED FROM FTC-TDR-62-21 "YHU-1B  
 CATEGORY II PERFORMANCE TESTS" AND LYCOMING ENGINE  
 SPECIFICATION NO. 104.22B (1) & 104.28

ENGINES: T53-L-11  
 ENGINE RPM: 6600  
 FUEL GRADE: JP-4  
 FUEL DENSITY: 6.5 LBS/GAL.

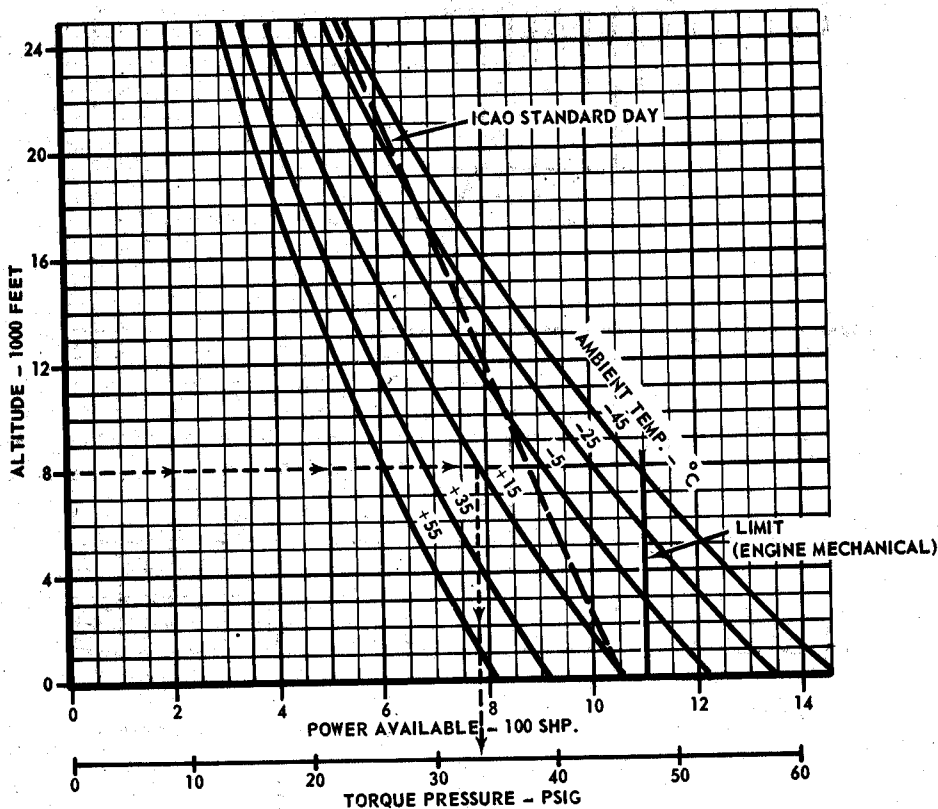

REMARKS:

Figure 14-4. Engine operating limits (Sheet 5 of 6)

# ENGINE OPERATING LIMITS

TAKE-OFF POWER AVAILABLE  
10°C INLET TEMPERATURE RISE

ARMY MODEL(S): AH-1G  
 DATA AS OF: SEPTEMBER 1962  
 DATA BASIS: CALCULATED FROM FTC-TDR-62-21 "YUH-1B  
 CATEGORY II PERFORMANCE TESTS" AND LYCOMING ENGINE  
 SPECIFICATION NO. 104.28

ENGINES: T53-L-11  
 ENGINE RPM: 6600  
 FUEL GRADE: JP-4  
 FUEL DENSITY: 6.5 LBS/GAL.

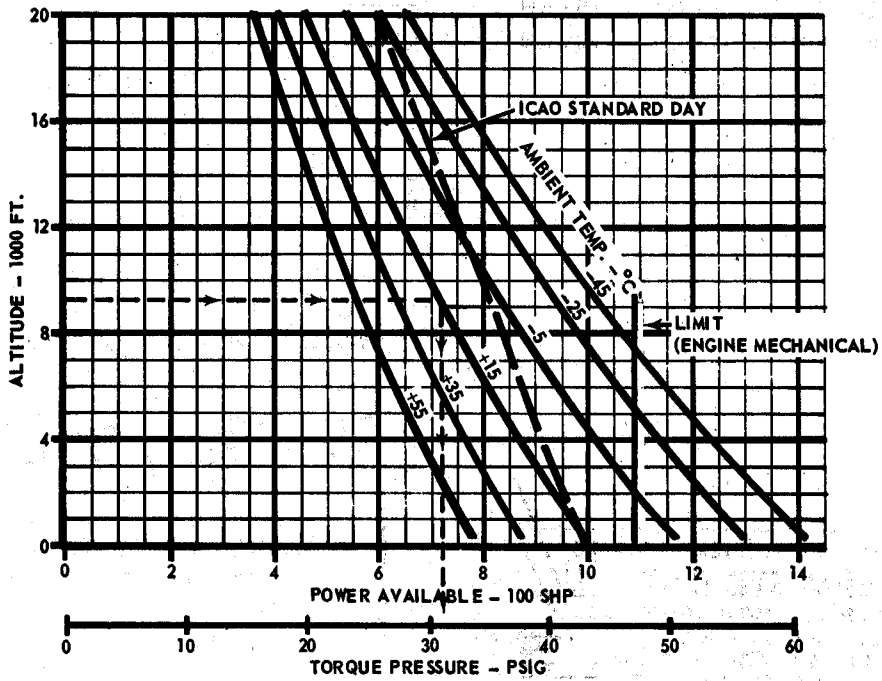

REMARKS:

Figure 14-4. Engine operating limits (Sheet 6 of 6)

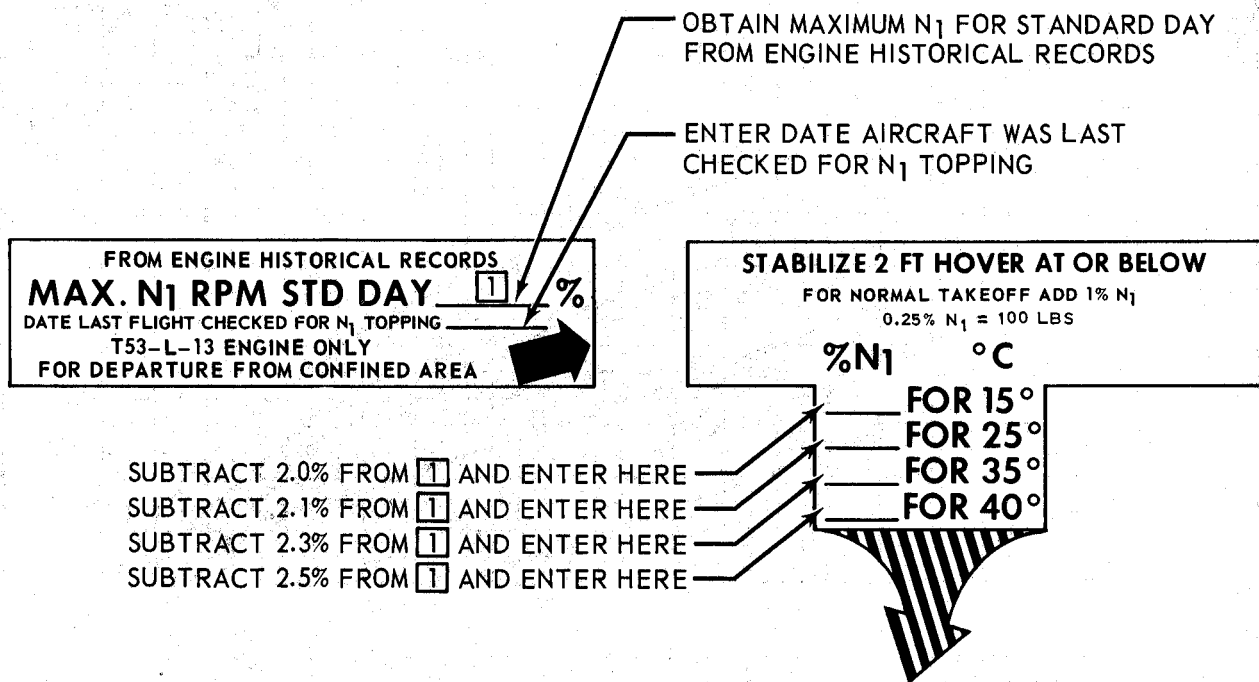

209070-14A

Figure 14-5. Go-No-Go take-off data placard

13

# MAXIMUM GROSS WEIGHT FOR VERTICAL TAKE-OFF

13

NORMAL RATED POWER

Model(s): AH-1G  
Data as of: 7 January 1966  
DATA BASIS: Preliminary Phase D UH-1B (540)

Engine(s): T53-L-13  
Engine RPM: 6600  
Fuel Grade: JP-4  
Fuel Density: 6.5 LB/GAL.

2°C INLET TEMPERATURE RISE

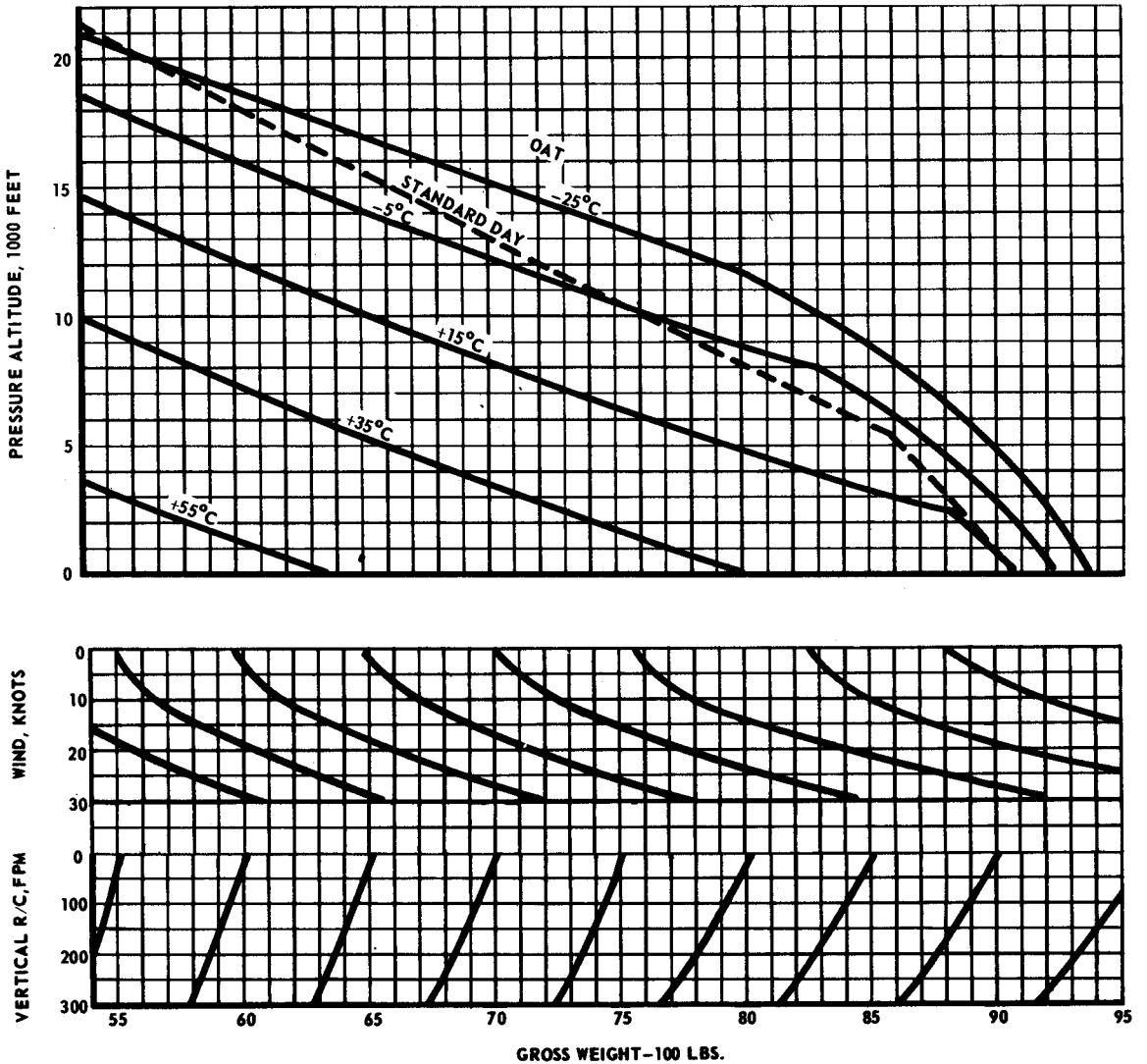

Figure 14-6. Maximum gross weight for vertical take-off (Sheet 1 of 7)

13

# MAXIMUM GROSS WEIGHT FOR VERTICAL TAKE-OFF

13

Model(s): AH-1G  
Data as of: 7 January 1966  
DATA BASIS: Preliminary Phase D UH-1B (540)

Engine(s): T53-L-13  
Engine RPM: 6600  
Fuel Grade: JP-4  
Fuel Density: 6.5 Lb/GAL

2°C INLET TEMPERATURE RISE

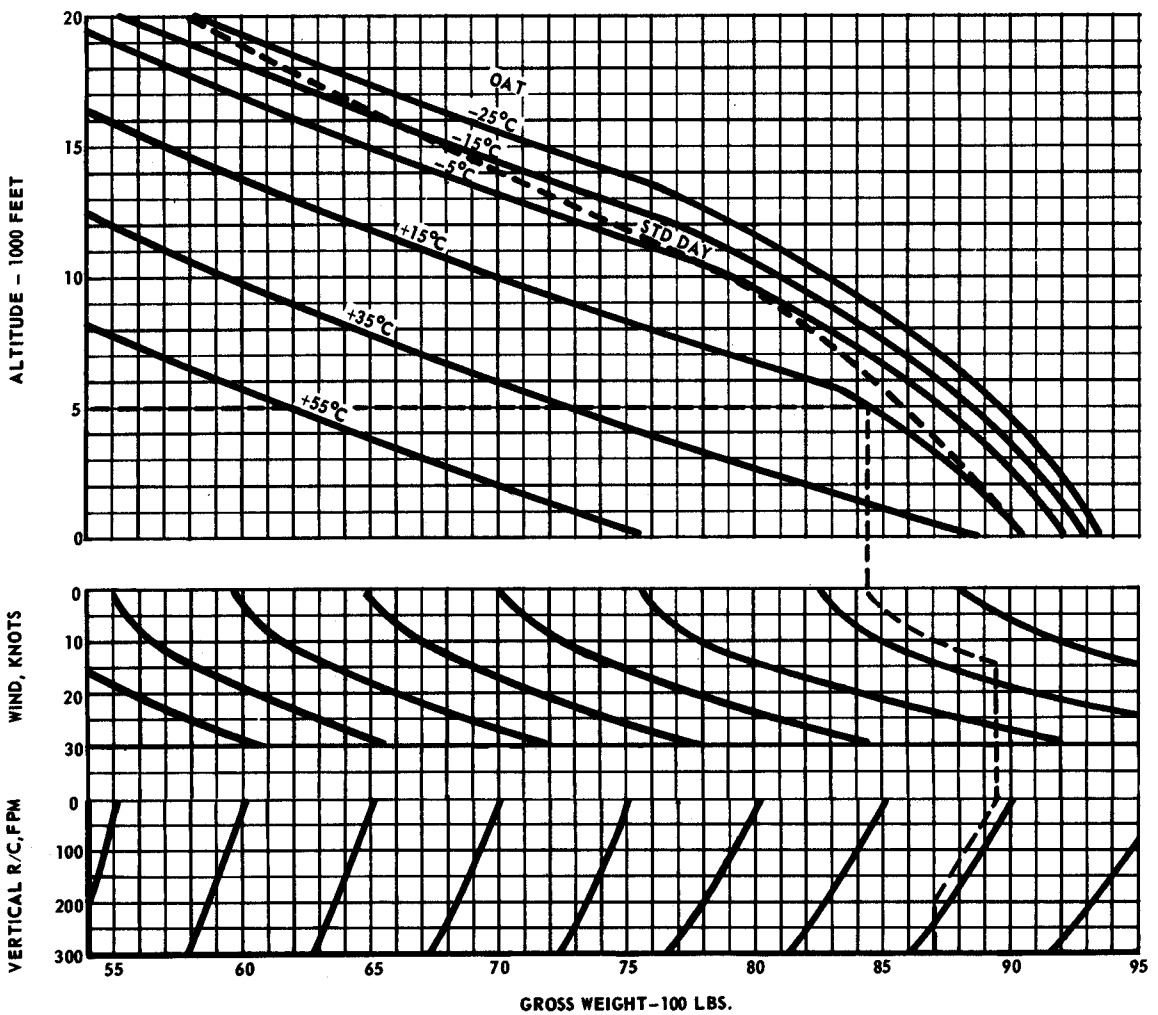

Figure 14-6. Maximum gross weight for vertical take-off (Sheet 2 of 7)

13

# MAXIMUM GROSS WEIGHT FOR VERTICAL TAKE-OFF

13

MILITARY POWER

Model(s): AH-1G  
Data as of: 7 January 1966  
DATA BASIS: Preliminary Phase D UH-1B (540)

Engine(s): T53-L-13  
Engine RPM: 6600  
Fuel Grade: JP-4  
Fuel Density: 6.5 LB/GAL.

5°C INLET TEMPERATURE RISE

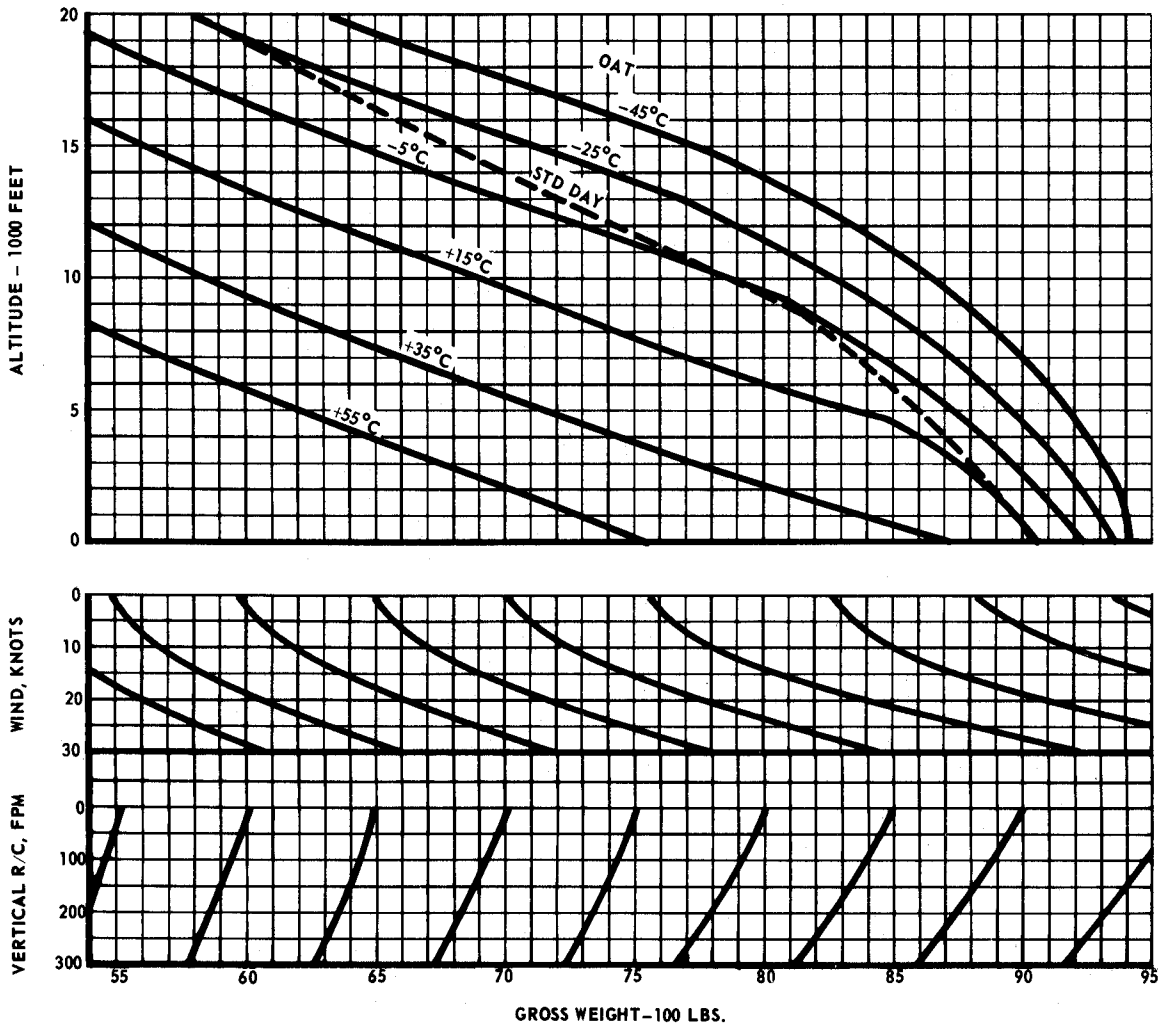

Figure 14-6. Maximum gross weight for vertical take-off (Sheet 3 of 7)

# MAXIMUM GROSS WEIGHT FOR VERTICAL TAKE-OFF

NORMAL POWER

Model(s): AH-1G  
 Data as of: 15 February 1967  
 DATA BASIS: Preliminary Phase D UH-1D (540)

Engine(s): T53-L-11  
 Engine RPM: 6600  
 Fuel Grade: JP-4  
 Fuel Density: 6.5 LB/GAL.

2°C Inlet Temperature Rise

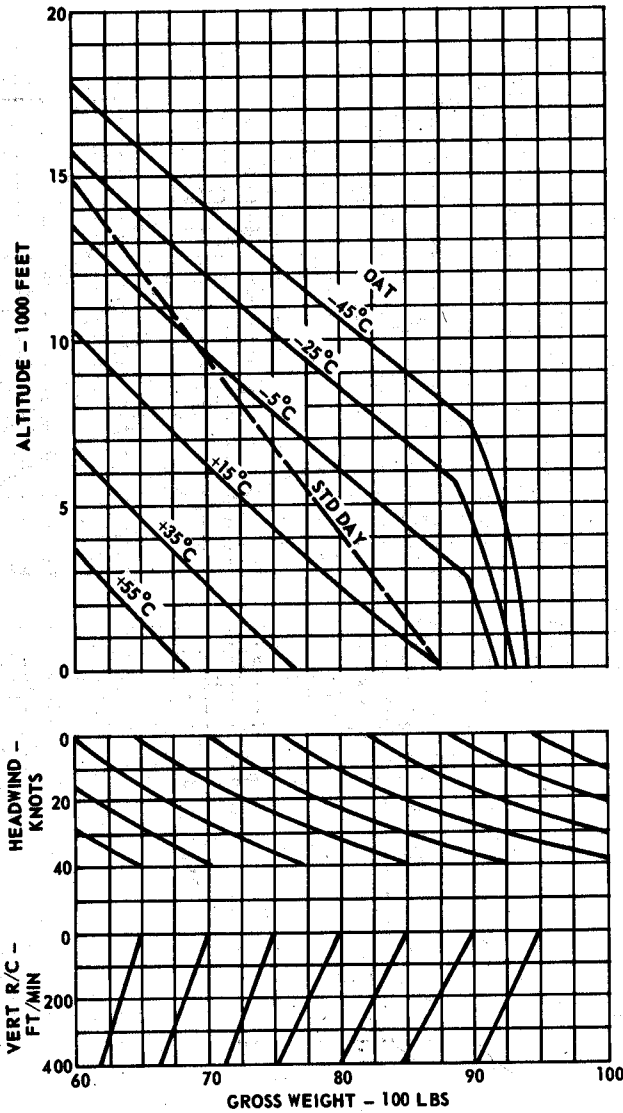

REMARKS:

Figure 14-6. Maximum gross weight for vertical take-off (Sheet 4 of 7)



# MAXIMUM GROSS WEIGHT FOR VERTICAL TAKE-OFF

TAKE-OFF POWER

Model(s): AH-1G

Data as of: 15 February 1967

DATA BASIS: Preliminary Phase D UH-1B (540)

Engine(s): T53-L-11

Engine RPM: 6600

Fuel Grade: JP-4

Fuel Density: 6.5 LB/GAL.

2°C Inlet Temperature Rise

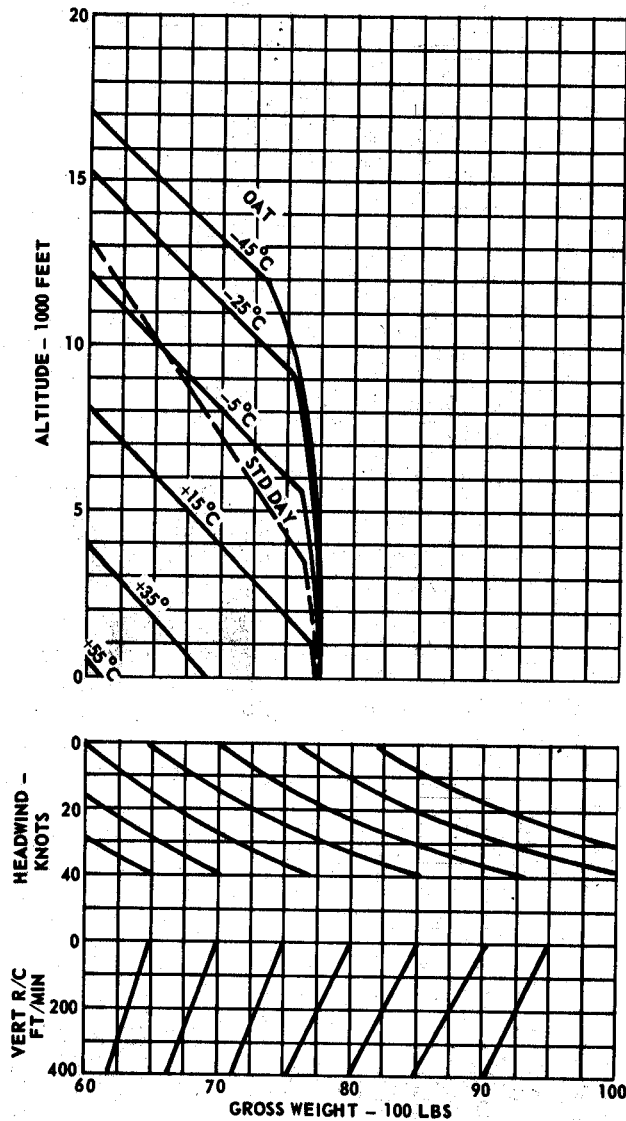

Figure 14-6. Maximum gross weight for vertical take-off (Sheet 5 of 7)

# MAXIMUM GROSS WEIGHT FOR VERTICAL TAKE-OFF

Model(s): AH-1G  
 Data as of: 15 February 1967  
 DATA BASIS: Preliminary Phase D UH-1D (540)

NORMAL POWER

Engine(s): T53-L-11  
 Engine RPM: 6800  
 Fuel Grade: JP-4  
 Fuel Density: 6.5 LB/GAL.

5°C Inlet Temperature Rise

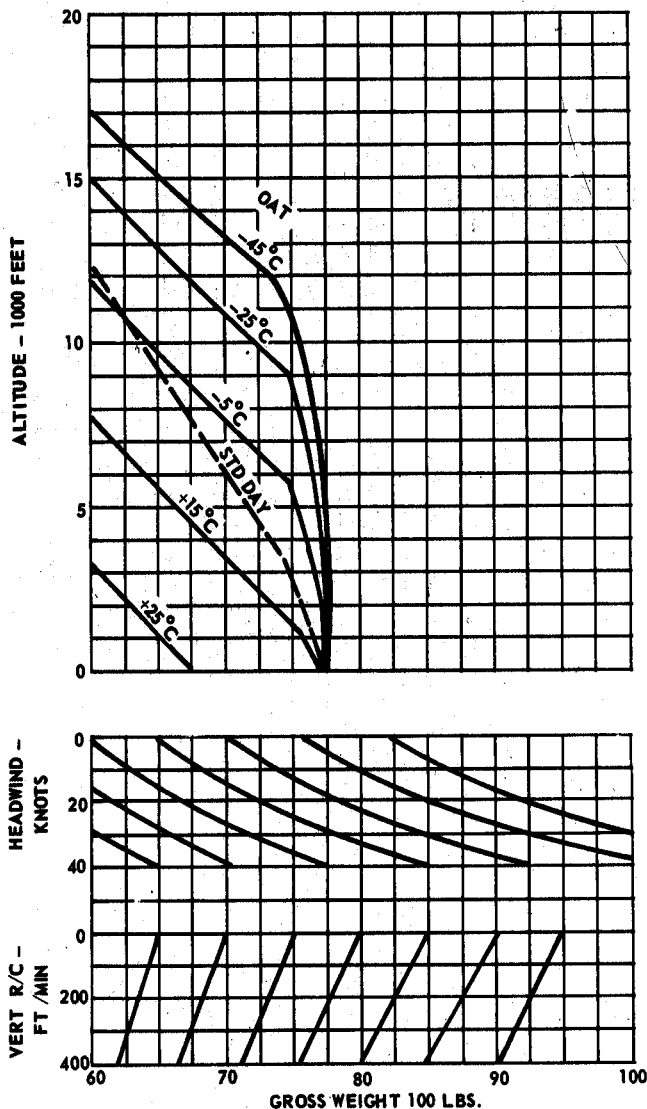

Figure 14-6. Maximum gross weight for vertical take-off (Sheet 6 of 7)

# MAXIMUM GROSS WEIGHT FOR VERTICAL TAKE-OFF

TAKE-OFF POWER

Model(s): AH-1G  
Data as of: 15 February 1967  
DATA BASIS: Preliminary Phase D UH-1B (540)

Engine(s): T53-L-11  
Engine RPM: 6600  
Fuel Grade: JP-4  
Fuel Density: 6.5 LB/GAL.

5°C Inlet Temperature Rise

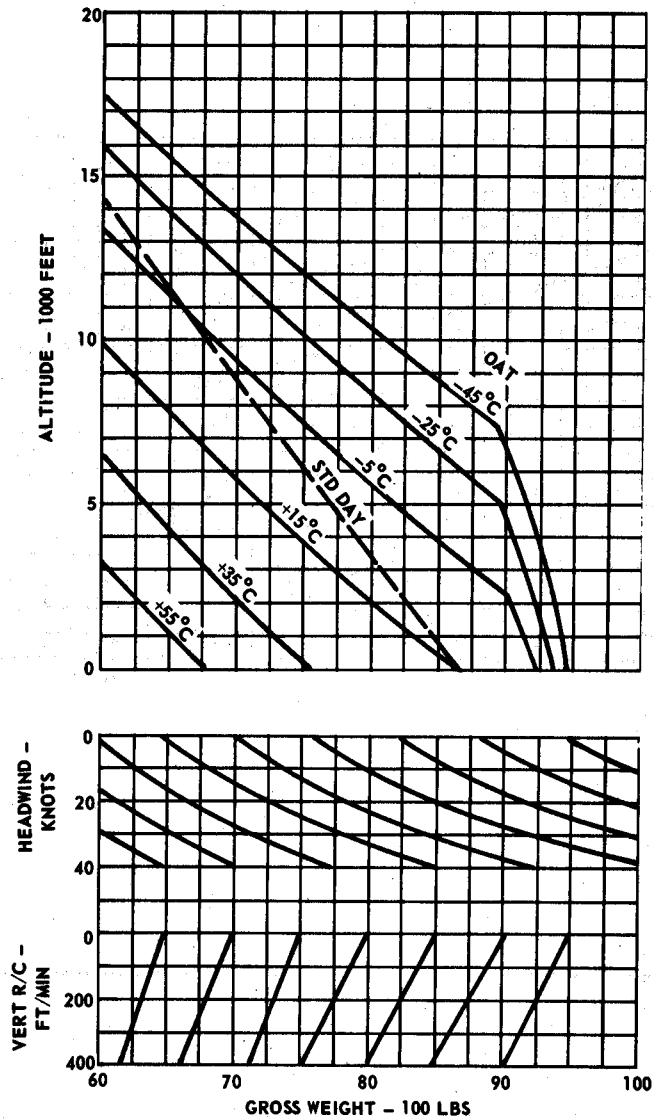

Figure 14-6. Maximum gross weight for vertical take-off (Sheet 7 of 7)

13

# HOVERING IN GROUND EFFECT

13

NORMAL POWER - 2 FOOT SKID HEIGHT

Model(s): AH-1G

Data as of: 7 January 1966

DATA BASIS: Preliminary Phase D UH-1B (540)

Engine(s): T53-L-13

Engine RPM: 6600

Fuel Grade: JP-4

Fuel Density: 6.5 LB/GAL

2°C INLET TEMPERATURE RISE

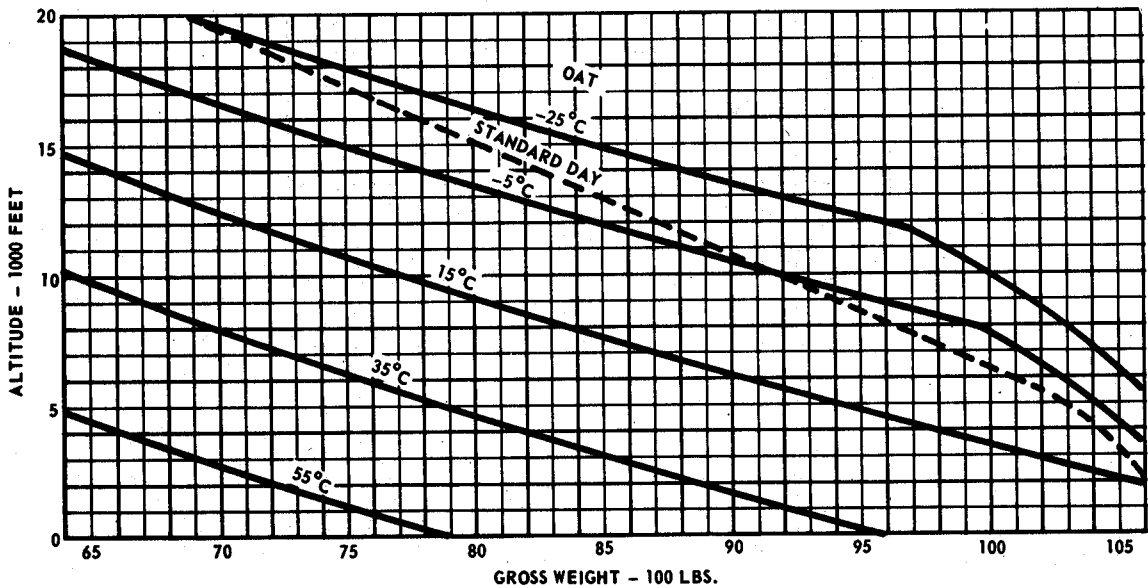

REMARKS:

Figure 14-7. Hovering chart (Sheet 1 of 12)

13

# HOVERING IN GROUND EFFECT

13

MILITARY POWER - 2 FOOT SKID HEIGHT

Model(s): AH-1G

Data as of: 7 January 1966

DATA BASIS: Preliminary Phase D UH-1B (540)

Engine(s): T53-L-13

Engine RPM: 6600

Fuel Grade: JP-4

Fuel Density: 6.5 LB/GAL.

2°C INLET TEMPERATURE RISE

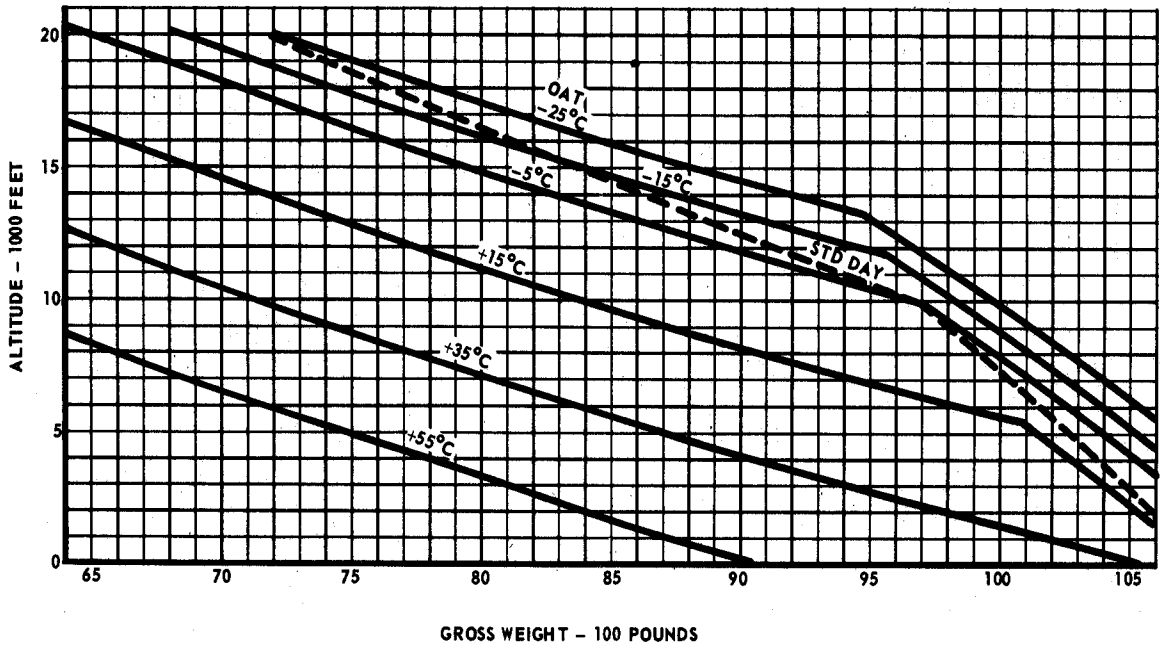

REMARKS:

Figure 14-7. Hovering chart (Sheet 2 of 12)

13

# HOVERING IN GROUND EFFECT

13

MILITARY POWER - 15 FOOT SKID HEIGHT

Model(s): AH-1G

Data as of: 7 January 1966

DATA BASIS: Preliminary Phase D UH-1B (540)

Engine(s): T53-L-13

Engine RPM: 6600

Fuel Grade: JP-4

Fuel Density: 6.5 LB/GAL.

2°C INLET TEMPERATURE RISE

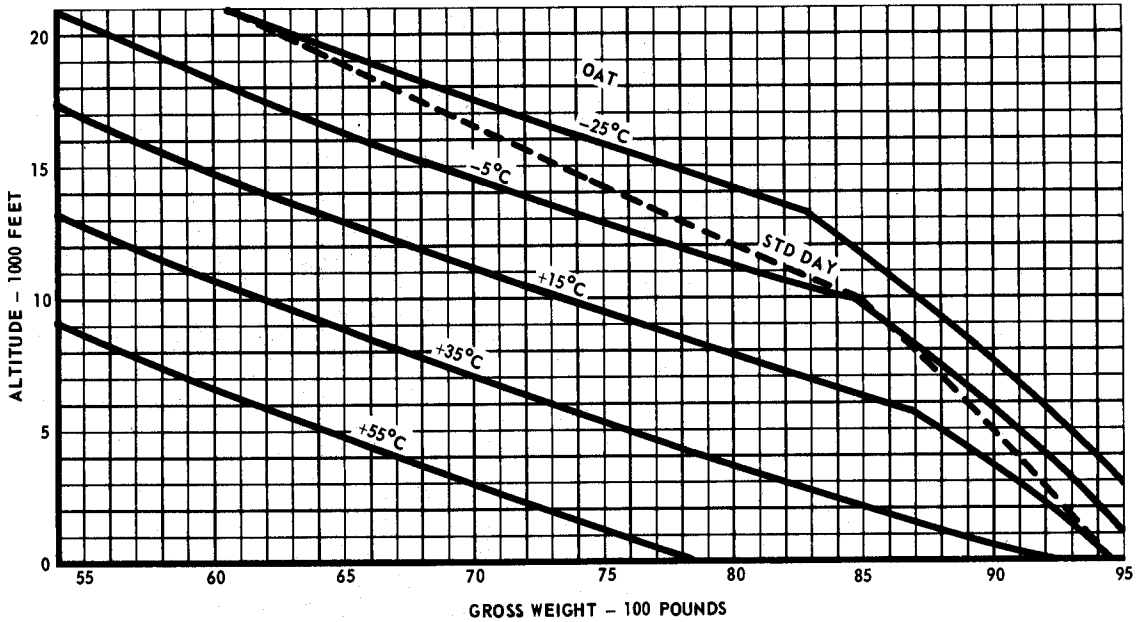

REMARKS:

Figure 14-7. Hovering chart (Sheet 3 of 12)

13

13

# HOVERING IN GROUND EFFECT

MILITARY POWER

Model(s): AH-1G  
Data as of: 7 January 1966  
DATA BASIS: Preliminary Phase D UH-1B (540)

Engine(s): T53-L-13  
Engine RPM: 6600  
Fuel Grade: JP-4  
Fuel Density: 6.5 LB/GAL.

5°C INLET TEMPERATURE RISE

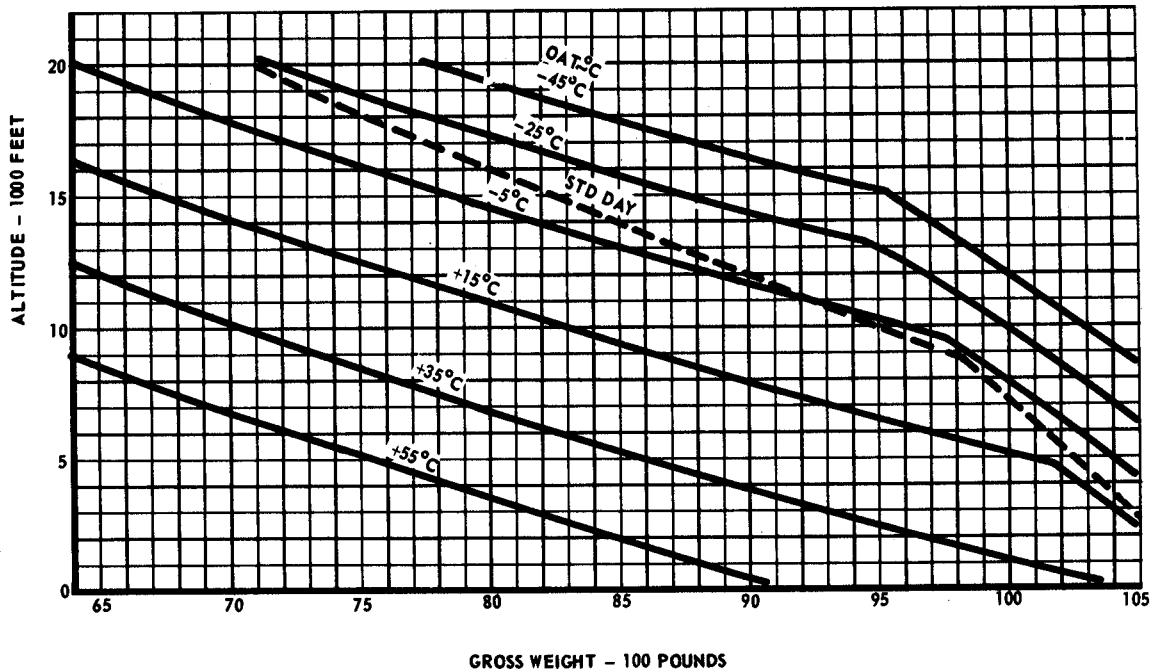

REMARKS:

Figure 14-7. Hovering chart (Sheet 4 of 12)

# HOVERING IN GROUND EFFECT

NORMAL POWER - 2 FOOT SKID HEIGHT

Model(s): AH-1G  
 Data as of: 15 February 1967  
 DATA BASIS: Preliminary Phase D UH-1B (540)

Engine(s): T53-L-11  
 Engine RPM: 6800  
 Fuel Grade: JP-4  
 Fuel Density: 6.5 LB/GAL.

2°C Inlet Temperature Rise

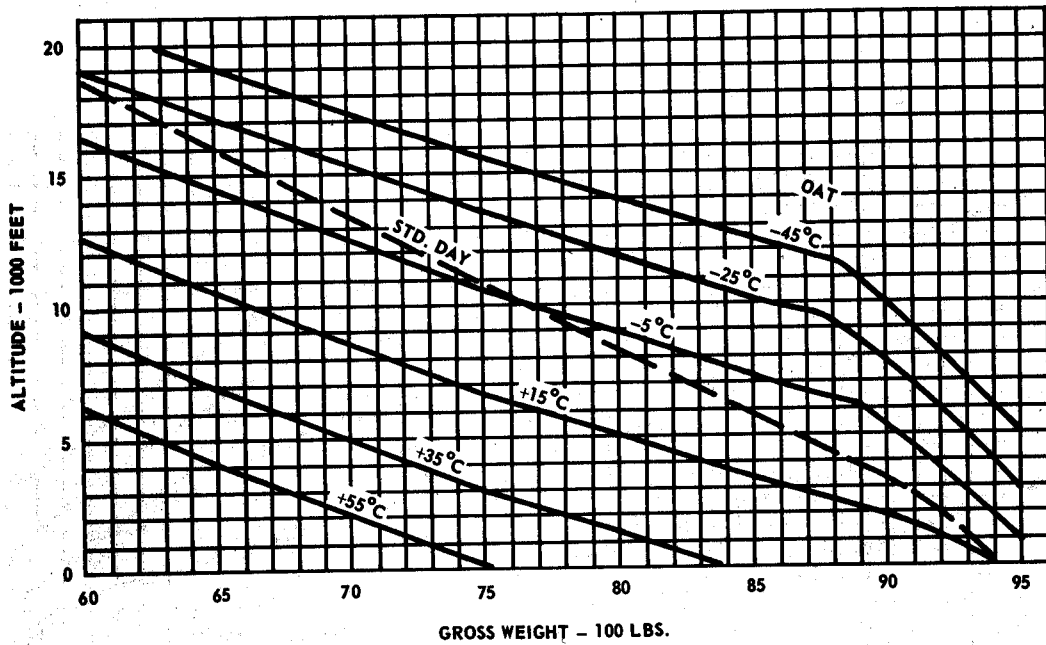

REMARKS:

Figure 14-7. Hovering chart (Sheet 5 of 12)



# HOVERING IN GROUND EFFECT

NORMAL POWER - 2 FOOT SKID HEIGHT

Model(s): AH-1G  
Data as of: 15 February 1967  
DATA BASIS: Preliminary Phase D UH-1B (540)

Engine(s): T53-L-11  
Engine RPM: 6600  
Fuel Grade: JP-4  
Fuel Density: 6.5 LB/GAL.

5°C Inlet Temperature Rise

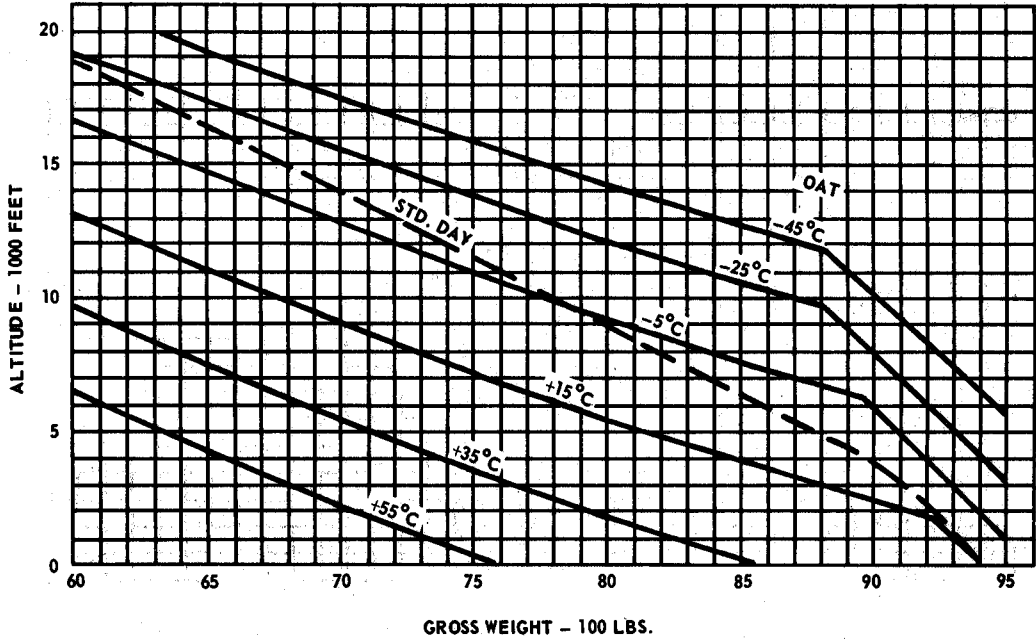

REMARKS:

Figure 14-7. Hovering chart (Sheet 6 of 12)

# HOVERING IN GROUND EFFECT

NORMAL POWER - 15 FOOT SKID HEIGHT

Model(s): AH-1G  
Data as of: 15 February 1967  
DATA BASIS: Preliminary Phase D UH-1B<sup>1</sup> (540)

Engine(s): T53-L-11  
Engine RPM: 6600  
Fuel Grade: JP-4  
Fuel Density: 6.5 LB/GAL.

2°C Inlet Temperature Rise

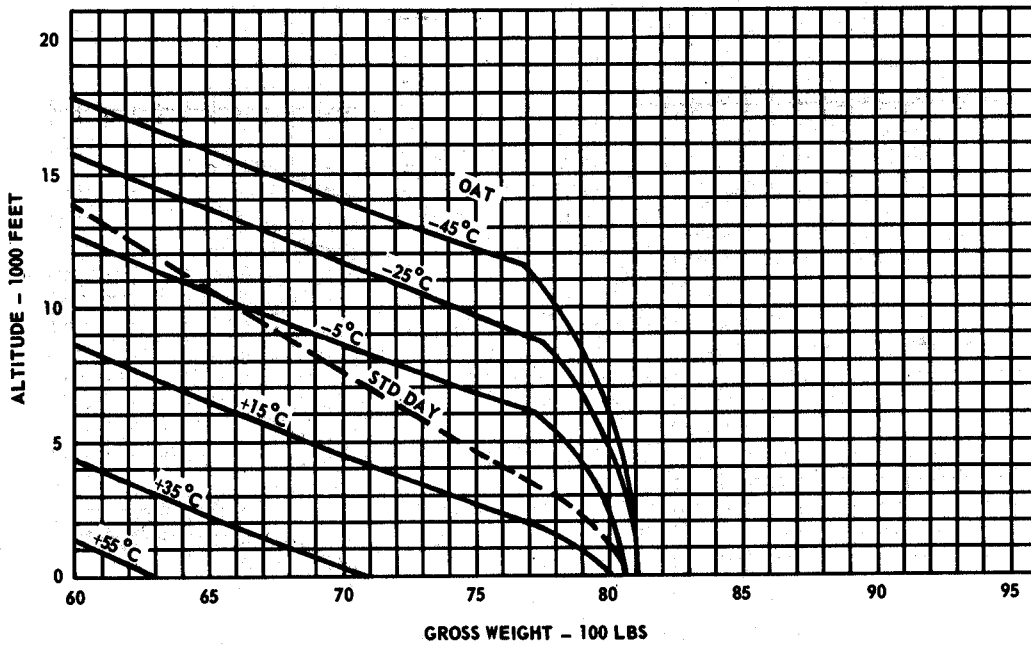

REMARKS:

Figure 14-7. Hovering chart (Sheet 7 of 12)

# HOVERING IN GROUND EFFECT

NORMAL POWER - 15 FOOT SKID HEIGHT

Model(s): AH-1G

Data as of: 15 February 1967

DATA BASIS: Preliminary Phase D UH-1B (540)

Engine(s): T53-L-11

Engine RPM: 6600

Fuel Grade: JP-4

Fuel Density: 6.5 LB/GAL.

5°C Inlet Temperature Rise

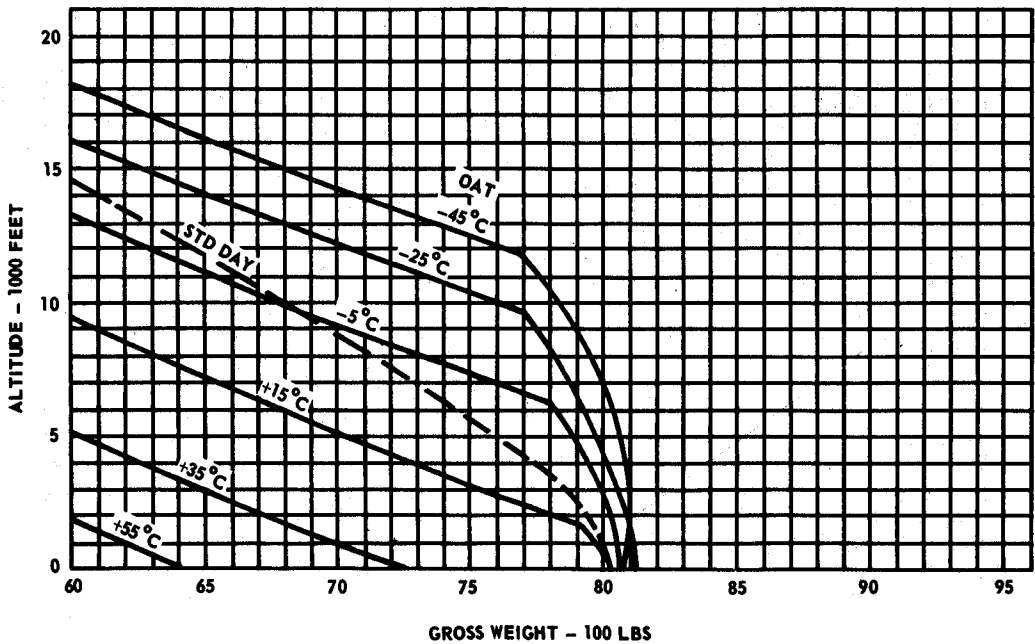

REMARKS:

Figure 14-7. Hovering chart (Sheet 8 of 12)

# HOVERING IN GROUND EFFECT

TAKE-OFF POWER - 2 FOOT SKID HEIGHT

Model(s): AH-1G

Data as of: 15 February 1967

DATA BASIS: Preliminary Phase D UH-1B (540)

Engine(s): T53-L-11

Engine RPM: 6600

Fuel Grade: JP-4

Fuel Density: 6.5 LB/GAL.

2°C Inlet Temperature Rise

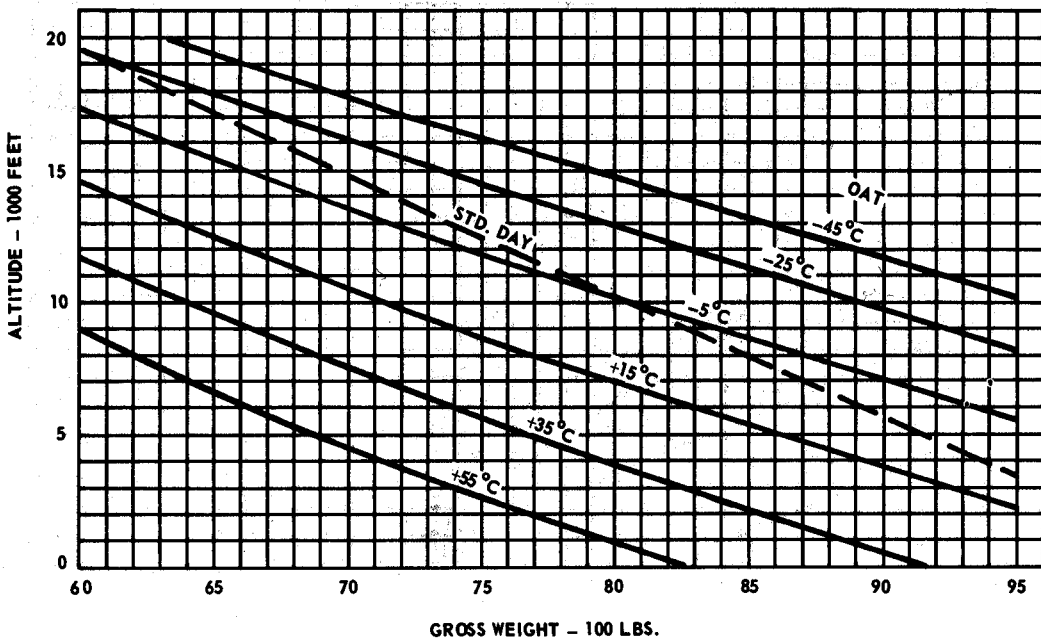

REMARKS:

Figure 14-7. Hovering chart (Sheet 9 of 12)

# HOVERING IN GROUND EFFECT

Model(s): AH-1G

Data as of: 15 February 1967

DATA BASIS: Preliminary Phase D UH-1B (540)

TAKE-OFF POWER - 2 FOOT SKID HEIGHT

Engine(s): T53-L-11

Engine RPM: 6600

Fuel Grade: JP-4

Fuel Density: 6.5 LB/GAL.

5°C Inlet Temperature Rise

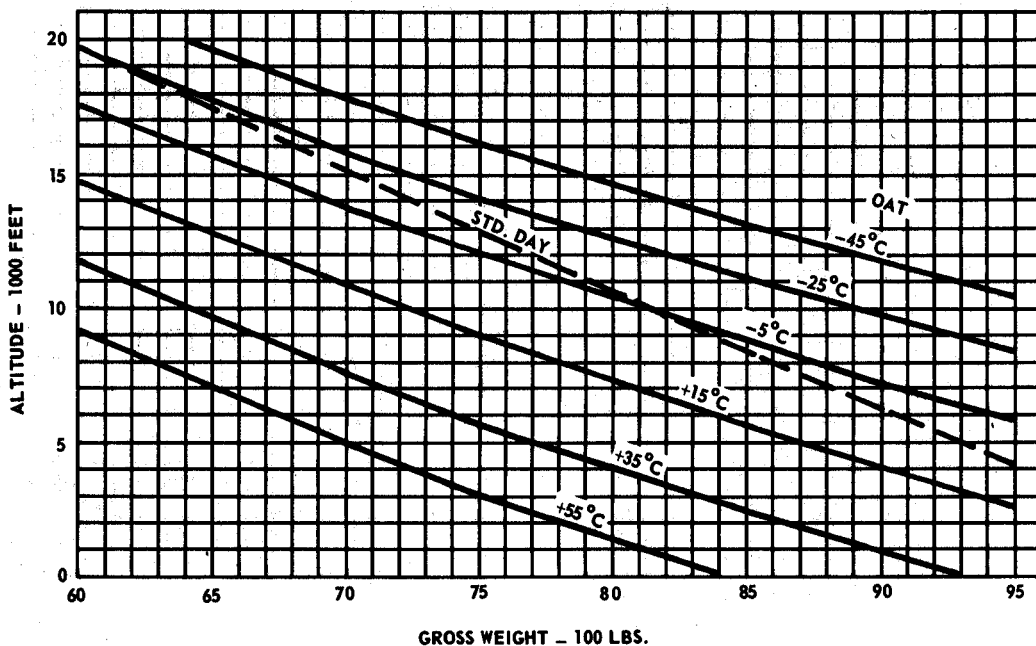

REMARKS:

Figure 14-7. Hovering chart (Sheet 10 of 12)

# HOVERING IN GROUND EFFECT

TAKE-OFF POWER - 15 FOOT SKID HEIGHT

Model(s): AH-1G

Data as of: 15 February 1967

DATA BASIS: Preliminary Phase D UH-1B (540)

Engine(s): T53-L-11

Engine RPM: 6600

Fuel Grade: JP-4

Fuel Density: 6.5 LB/GAL.

2°C Inlet Temperature Rise

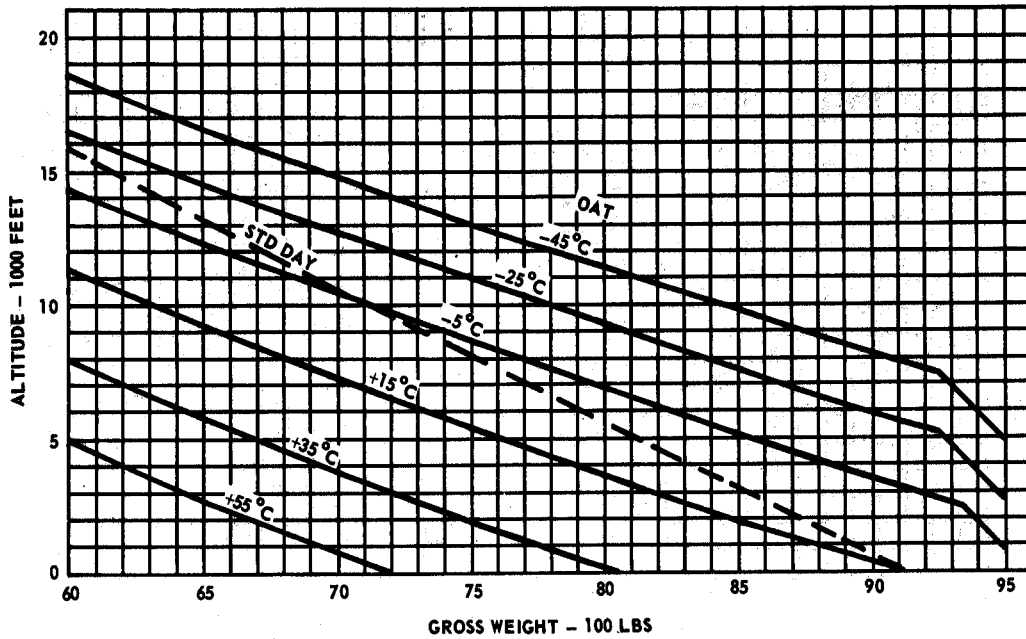

REMARKS:

Figure 14-7. Hovering chart (Sheet 11 of 12)

# HOVERING IN GROUND EFFECT

TAKE-OFF POWER - 15 FOOT SKID HEIGHT

Model(s): AH-1G  
Data as of: 15 February 1967  
DATA BASIS: Preliminary Phase D UH-1B (540)

Engine(s): T53-L-11  
Engine RPM: 6600  
Fuel Grade: JP-4  
Fuel Density: 6.5 LB/GAL.

5°C Inlet Temperature Rise

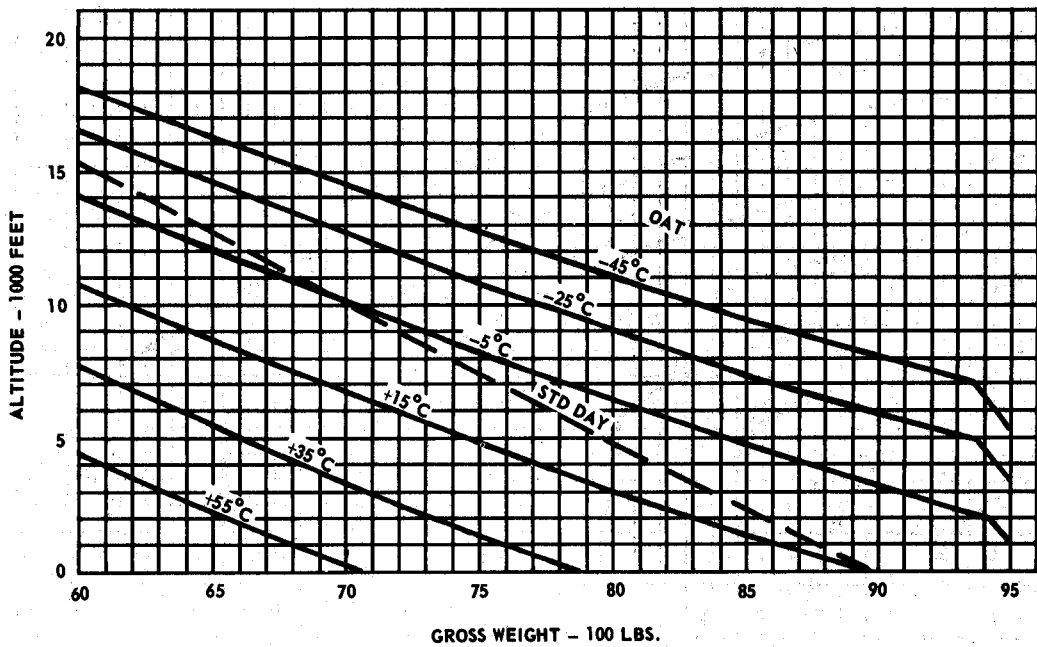

REMARKS:

figure 14-7. Hovering chart (Sheet 12 of 12)

13

# VERTICAL RATE OF CLIMB

## ICAO STANDARD DAY

13

MILITARY POWER

Model(s): AH-1G  
 Data as of: 7 January 1966  
 DATA BASIS: Preliminary Phase D UH-1B (540)

Engine(s): T53-L-13  
 Engine RPM: 6600  
 Fuel Grade: JP-4  
 Fuel Density: 6.5 LB/GAL

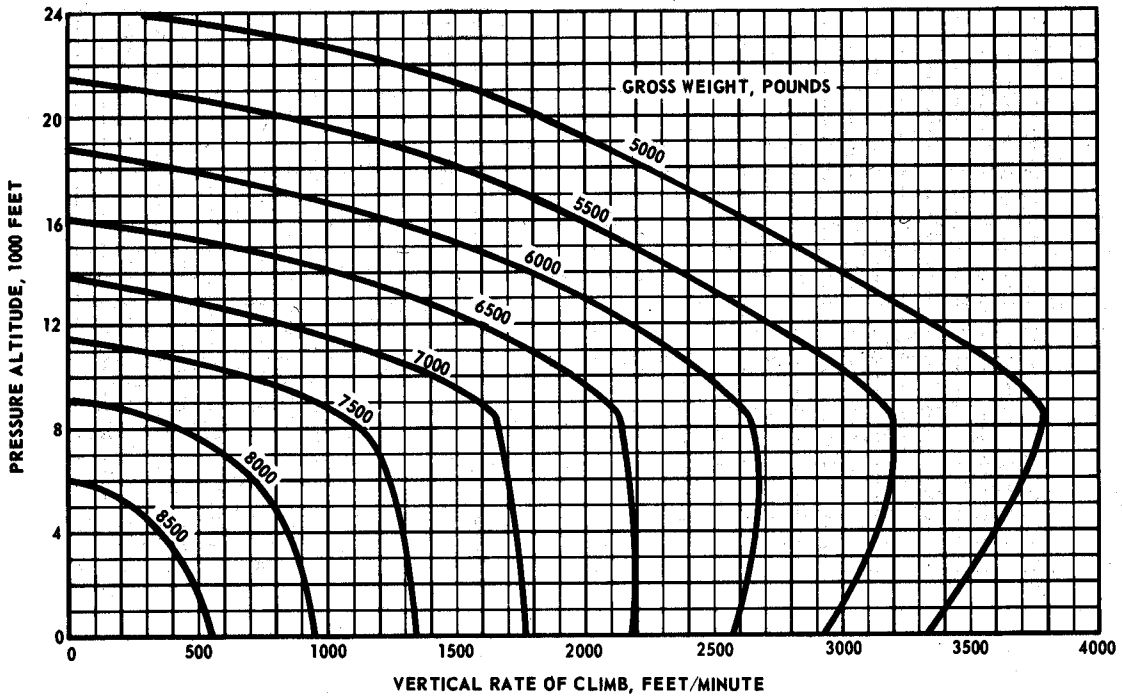

REMARKS:

Figure 14-8. Vertical rate of climb chart (Sheet 1 of 2)



# VERTICAL RATE OF CLIMB ICAO STANDARD DAY

TAKE-OFF POWER

Model(s): AH-1G  
Data as of: March 1967  
DATA BASIS: Preliminary Phase D UH-1B (540)

Engine(s): Lycoming T53-L-11  
Engine RPM: 6600  
Fuel Grade: JP-4  
Fuel Density: 6.5 LB/GAL

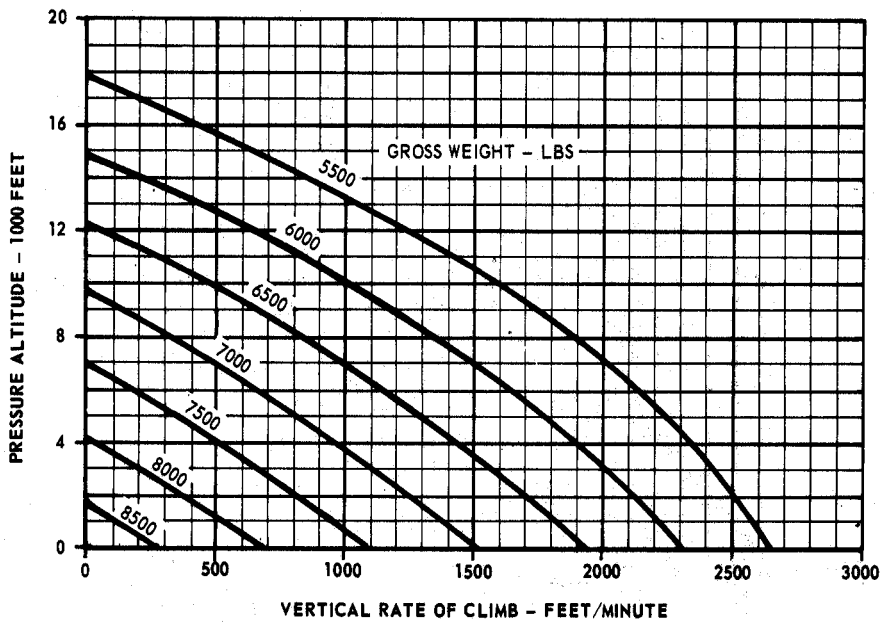

REMARKS:

Figure 14-8. Vertical rate of climb chart (Sheet 2 of 2)

13

# TAKE-OFF DISTANCE — FEET

13

MAXIMUM PERFORMANCE - TWO FOOT SKID HEIGHT - HOVERING TECHNIQUE  
TAKE-OFF POWER - 6600 RPM

Model(s): AH-1G  
Data as of: JULY 1966  
DATA BASIS: ESTIMATED

Engine(s): Lycoming T53-L-13  
Fuel Grade: JP-4  
Fuel Density: 6.5 LB/GAL.

GROSS WT. LB.	PRESSURE ALTITUDE 1000 FEET	-25° C (-13° F)		-5° C (+23° F)		+15° C (+59° F)		+35° C (+95° F)		+55° C (+131° F)		CLIMB OUT SPEED TAS KNOTS	DIST TO CLEAR 50 FT.	CLIMB OUT SPEED TAS KNOTS	DIST TO CLEAR 50 FT.	
		CLIMB OUT SPEED TAS KNOTS	DIST TO CLEAR 50 FT.	CLIMB OUT SPEED TAS KNOTS	DIST TO CLEAR 50 FT.	CLIMB OUT SPEED TAS KNOTS	DIST TO CLEAR 50 FT.	CLIMB OUT SPEED TAS KNOTS	DIST TO CLEAR 50 FT.	CLIMB OUT SPEED TAS KNOTS	DIST TO CLEAR 50 FT.					
6000	0	0	0	0	0	0	0	0	0	0	0					
	2000	0	0	0	0	0	0	0	0	0	0					
	4000	0	0	0	0	0	0	0	0	0	0					
	6000	0	0	0	0	0	0	0	0	0	30	297				
	8000	0	0	0	0	0	0	0	0	0	30	433				
	10000	0	0	0	0	0	0	0	0	0						
	12000	0	0	0	0	0	0	30	459							
	14000	0	0	0	0	30	267									
	18000	0	0	0	0	30	618									
6000	18000	0	0	30	336											
	20000	30	281													
6500	0	0	0	0	0	0	0	0	0	0	0					
	2000	0	0	0	0	0	0	0	0	0	0					
	4000	0	0	0	0	0	0	0	0	0	0					
	6000	0	0	0	0	0	0	0	0	0	30	416				
	8000	0	0	0	0	0	0	0	0	0						
	10000	0	0	0	0	0	0	30	457							
	12000	0	0	0	0	30	266									
	14000	0	0	0	0	30	611									
6500	16000	0	0	30	334											
	18000	30	297													

- REMARKS:
1. No wind.
  2. Takeoff distance is zero when hovering out-of-ground effect is possible.
  3. No takeoff distance is shown where hovering with 2-foot skid height is not possible.
  4. Takeoff distance will exceed those shown if hovering in-ground-effect is performed for over one minute immediately prior to takeoff.
  5. Speed over the 50-foot obstacle is True Airspeed (TAS).

Figure 14-9. Take-off distance chart (Sheet 1 of 8)

13

# TAKE-OFF DISTANCE — FEET

MAXIMUM PERFORMANCE - TWO FOOT SKID HEIGHT - HOVERING TECHNIQUE  
TAKE-OFF POWER - 6600 RPM

Model(s): AH-1G  
Data as of: JULY 1966  
DATA BASIS: ESTIMATED

Engine(s): Lycoming T53-L-13  
Fuel Grade: JP-4  
Fuel Density: 6.5 LB/GAL.

GROSS WT. LB.	PRESSURE ALTITUDE 1000 FEET	-25° C (-13° F)		-5° C (+23° F)		+15° C (+59° F)		+35° C (+95° F)		+55° C (+131° F)					
		CLIMB OUT SPEED TAS KNOTS	DIST TO CLEAR 50 FT.	CLIMB OUT SPEED TAS KNOTS	DIST TO CLEAR 50 FT.	CLIMB OUT SPEED TAS KNOTS	DIST TO CLEAR 50 FT.	CLIMB OUT SPEED TAS KNOTS	DIST TO CLEAR 50 FT.	CLIMB OUT SPEED TAS KNOTS	DIST TO CLEAR 50 FT.	CLIMB OUT SPEED TAS KNOTS	DIST TO CLEAR 50 FT.	CLIMB OUT SPEED TAS KNOTS	DIST TO CLEAR 50 FT.
7000	0	0	0	0	0	0	0	0	0	0	0				
	2000	0	0	0	0	0	0	0	0	0	0				
	4000	0	0	0	0	0	0	0	0	0	30	390			
	6000	0	0	0	0	0	0	0	0	0					
	8000	0	0	0	0	0	0	30	435						
	10000	0	0	0	0	0	0								
	12000	0	0	0	0	30	571								
	14000	0	0	30	320										
7000	16000	30	267	30	635										
7500	0	0	0	0	0	0	0	0	0	0	0				
	2000	0	0	0	0	0	0	0	0	30	366				
	4000	0	0	0	0	0	0	0	0	30	779				
	6000	0	0	0	0	0	0	30	400						
	8000	0	0	0	0	0	0								
	10000	0	0	0	0	30	503								
	12000	0	0	30	298										
	14000	30	250	30	555										
7500	16000	30	421												

- REMARKS:
1. No wind.
  2. Takeoff distance is zero when hovering out-of-ground effect is possible.
  3. No takeoff distance is shown where hovering with 2-foot skid height is not possible.
  4. Takeoff distance will exceed those shown if hovering in-ground-effect is performed for over one minute immediately prior to takeoff.
  5. Speed over the 50-foot obstacle is True Airspeed (TAS).

Figure 14-9. Take-off distance chart (Sheet 2 of 8)

13

# TAKE-OFF DISTANCE — FEET

13

MAXIMUM PERFORMANCE - TWO FOOT SKID HEIGHT - HOVERING TECHNIQUE  
TAKE-OFF POWER - 6600 RPM

Model(s): AH-1G  
Data as of: JULY 1966  
DATA BASIS: ESTIMATED

Engine(s): Lycoming T53-L-13  
Fuel Grade: JP-4  
Fuel Density: 6.5 LB/GAL.

GROSS WT. LB.	PRESSURE ALTITUDE 1000 FEET	-25° C (-13° F)		-5° C (+23° F)		+15° C (+59° F)		+35° C (+95° F)		+55° C (+131° F)					
		CLIMB OUT SPEED TAS KNOTS	DIST TO CLEAR 50 FT.	CLIMB OUT SPEED TAS KNOTS	DIST TO CLEAR 50 FT.	CLIMB OUT SPEED TAS KNOTS	DIST TO CLEAR 50 FT.	CLIMB OUT SPEED TAS KNOTS	DIST TO CLEAR 50 FT.	CLIMB OUT SPEED TAS KNOTS	DIST TO CLEAR 50 FT.	CLIMB OUT SPEED TAS KNOTS	DIST TO CLEAR 50 FT.	CLIMB OUT SPEED TAS KNOTS	DIST TO CLEAR 50 FT.
8000	0	0	0	0	0	0	0	0	0	30	351				
	2000	0	0	0	0	0	0	0	0	30	628				
	4000	0	0	0	0	0	0	30	361						
	6000	0	0	0	0	0	0								
	8000	0	0	0	0	30	411								
	10000	0	0	30	266										
	12000	30	267	30	473										
8000	14000	30	368												
8500	0	0	0	0	0	0	0	0	0	30	538				
	2000	0	0	0	0	0	0	30	321						
	4000	0	0	0	0	0	0	30	674						
	6000	0	0	0	0	30	335								
	8000	0	0	30	307										
	10000	30	306	30	308										
8500	12000	30	409												

- REMARKS:
1. No wind.
  2. Takeoff distance is zero when hovering out-of-ground effect is possible.
  3. No takeoff distance is shown where hovering with 2-foot skid height is not possible.
  4. Takeoff distance will exceed those shown if hovering in-ground-effect is performed for over one minute immediately prior to takeoff.
  5. Speed over the 50-foot obstacle is True Airspeed (TAS).

Figure 14-9. Take-off distance chart (Sheet 3 of 8)

13

# TAKE-OFF DISTANCE — FEET

13

MAXIMUM PERFORMANCE - TWO FOOT SKID HEIGHT - HOVERING TECHNIQUE  
TAKE-OFF POWER - 6600 RPM

Model(s): AH-1G  
Data as of: JULY 1966  
DATA BASIS: ESTIMATED

Engine(s): Lycoming T53-L-13  
Fuel Grade: JP-4  
Fuel Density: 6.5 LB/GAL.

GROSS WT. LB.	PRESSURE ALTITUDE 1000 FEET	-25° C (-13° F)		-5° C (+23° F)		+15° C (+59° F)		+35° C (+95° F)							
		CLIMB OUT SPEED TAS KNOTS	DIST TO CLEAR 50 FT.	CLIMB OUT SPEED TAS KNOTS	DIST TO CLEAR 50 FT.	CLIMB OUT SPEED TAS KNOTS	DIST TO CLEAR 50 FT.	CLIMB OUT SPEED TAS KNOTS	DIST TO CLEAR 50 FT.	CLIMB OUT SPEED TAS KNOTS	DIST TO CLEAR 50 FT.	CLIMB OUT SPEED TAS KNOTS	DIST TO CLEAR 50 FT.	CLIMB OUT SPEED TAS KNOTS	DIST TO CLEAR 50 FT.
9000	0	0	0	0	0	0	0	30	282						
	2000	0	0	0	0	30	284	30	513						
	4000	0	0	30	286	30	345								
	6000	30	284	30	348	30	646								
	8000	30	347	30	541										
9000	10000	30	540												
9500	0	30	309	30	319	30	337	30	411						
	2000	30	319	30	337	30	418								
	4000	30	335	30	421	30	744								
	6000	30	417	30	753										
9500	8000	30	748												

- REMARKS:
1. No wind.
  2. Takeoff distance is zero when hovering out-of-ground effect is possible.
  3. No takeoff distance is shown where hovering with 2-foot skid height is not possible.
  4. Takeoff distance will exceed those shown if hovering in-ground-effect is performed for over one minute immediately prior to takeoff.
  5. Speed over the 50-foot obstacle is True Airspeed (TAS).

Figure 14-9. Take-off distance chart (Sheet 4 of 8)

# TAKE-OFF DISTANCE — FEET

MAXIMUM PERFORMANCE - TWO FOOT SKID HEIGHT - HOVERING TECHNIQUE  
TAKE-OFF POWER - 6600 RPM

Model(s): AH-1G  
Data as of: JULY 1966  
DATA BASIS: ESTIMATED

Engine(s): Lycoming T53-L-11  
Fuel Grade: JP-4  
Fuel Density: 6.5 LB/GAL.

GROSS WT. LB.	PRESSURE ALTITUDE 1000 FEET	-25° C (-13° F)		-5° C (+23° F)		+15° C (+59° F)		+35° C (+95° F)		+55° C (+131° F)					
		CLIMB OUT SPEED TAS KNOTS	DIST TO CLEAR 50 FT.	CLIMB OUT SPEED TAS KNOTS	DIST TO CLEAR 50 FT.	CLIMB OUT SPEED TAS KNOTS	DIST TO CLEAR 50 FT.	CLIMB OUT SPEED TAS KNOTS	DIST TO CLEAR 50 FT.	CLIMB OUT SPEED TAS KNOTS	DIST TO CLEAR 50 FT.				
6000	0	0	0	0	0	0	0	0	0	0	0				
	2000	0	0	0	0	0	0	0	0	0	0				
	4000	0	0	0	0	0	0	0	0	30	291				
	6000	0	0	0	0	0	0	0	0	30	413				
	8000	0	0	0	0	0	0	30	340	30	648				
	10000	0	0	0	0	0	0	30	500						
	12000	0	0	0	0	30	369								
	14000	0	0	30	295	30	870								
	16000	30	279	30	563										
6000	18000	30	524												
	20000														
6500	0	0	0	0	0	0	0	0	0	0	0				
	2000	0	0	0	0	0	0	0	0	30	301				
	4000	0	0	0	0	0	0	30	350	30	695				
	6000	0	0	0	0	0	0	30	521						
	8000	0	0	0	0	30	377								
	10000	0	0	30	296	30	892								
	12000	30	277	30	559										
	14000	30	509												
6500	16000														

REMARKS:

1. No wind.
2. Take-off distance is zero when hovering out-of-ground effect is possible.
3. No take-off distance is shown where hovering with 2-foot skid height is not possible.
4. Take-off distance will exceed those shown if hovering in-ground-effect is performed for over one minute immediately prior to take-off.
5. Speed over the 50-foot obstacle is True Airspeed (TAS).

Figure 14-9. Take-off distance chart (Sheet 5 of 8)

II

# TAKE-OFF DISTANCE — FEET

II

MAXIMUM PERFORMANCE - TWO FOOT SKID HEIGHT - HOVERING TECHNIQUE  
TAKE-OFF POWER - 6600 RPM

Model(s): AH-1G  
Data as of: JULY 1966  
DATA BASIS: ESTIMATED

Engine(s): Lycoming T53-L-11  
Fuel Grade: JP-4  
Fuel Density: 6.5 LB/GAL.

GROSS WT. LB.	PRESSURE ALTITUDE 1000 FEET	-25° C (-13° F)		-5° C (+23° F)		+15° C (+59° F)		+35° C (+95° F)		+55° C (+131° F)					
		CLIMB OUT SPEED TAS KNOTS	DIST TO CLEAR 50 FT.	CLIMB OUT SPEED TAS KNOTS	DIST TO CLEAR 50 FT.	CLIMB OUT SPEED TAS KNOTS	DIST TO CLEAR 50 FT.	CLIMB OUT SPEED TAS KNOTS	DIST TO CLEAR 50 FT.	CLIMB OUT SPEED TAS KNOTS	DIST TO CLEAR 50 FT.				
7000	0	0	0	0	0	0	0	0	0	30	303				
	2000	0	0	0	0	0	0	0	0	30	436				
	4000	0	0	0	0	0	0	30	352	30	712				
	6000	0	0	0	0	0	0	30	521						
	8000	0	0	0	0	30	375								
	10000	0	0	30	291	30	846								
7000	12000	0	0	30	529										
	14000	30	474												
7500	0	0	0	0	0	0	0	0	0	30	427				
	2000	0	0	0	0	0	0	30	348	30	692				
	4000	0	0	0	0	0	0	30	502						
	6000	0	0	0	0	30	363								
	8000	0	0	30	281	30	753								
	10000	0	0	30	484										
7500	12000	30	429												

REMARKS:

1. No wind.
2. Take-off distance is zero when hovering out-of-ground effect is possible.
3. No take-off distance is shown where hovering with 2-foot skid height is not possible.
4. Take-off distance will exceed those shown if hovering in-ground-effect is performed for over one minute immediately prior to take-off.
5. Speed over the 50-foot obstacle is True Airspeed (TAS).

Figure 14-9. Take-off distance chart (Sheet 6 of 8)

# TAKE-OFF DISTANCE — FEET

MAXIMUM PERFORMANCE - TWO FOOT SKID HEIGHT - HOVERING TECHNIQUE  
TAKE-OFF POWER - 6600 RPM

Model(s): AH-1G  
Data as of: JULY 1966  
DATA BASIS: ESTIMATED

Engine(s): Lycoming T53-L-11  
Fuel Grade: JP-4  
Fuel Density: 6.5 LB/GAL.

GROSS WT. LB.	PRESSURE ALTITUDE 1000 FEET	-25° C (-13° F)		-5° C (+23° F)		+15° C (+59° F)		+35° C (+95° F)		+55° C (+131° F)					
		CLIMB OUT SPEED TAS KNOTS	DIST TO CLEAR 50 FT.	CLIMB OUT SPEED TAS KNOTS	DIST TO CLEAR 50 FT.	CLIMB OUT SPEED TAS KNOTS	DIST TO CLEAR 50 FT.	CLIMB OUT SPEED TAS KNOTS	DIST TO CLEAR 50 FT.	CLIMB OUT SPEED TAS KNOTS	DIST TO CLEAR 50 FT.				
8000	0	0	0	0	0	0	0	30	339	30	638				
	2000	0	0	0	0	0	0	30	476						
	4000	0	0	0	0	30	344								
	6000	0	0	0	0	30	653								
	8000	0	00	30	433										
8000	10000	30	382												
8500	0	0	0	0	0	0	0	30	448						
	2000	0	0	0	0	30	327								
	4000	0	0	0	0	30	559								
	6000	0	0	30	387										
	8000	30	341												
8500	10000	30	814												
9000	0	0	0	0	0	30	306	30	775						
	2000	0	0	0	0	30	475								
	4000	0	0	30	344										
	6000	30	305	30	704										
9000	8000	30	567												

REMARKS:

1. No wind.
2. Take-off distance is zero when hovering out-of-ground effect is possible.
3. No take-off distance is shown where hovering with 2-foot skid height is not possible.
4. Take-off distance will exceed those shown if hovering in-ground-effect is performed for over one minute immediately prior to take-off.
5. Speed over the 50-foot obstacle is True Airspeed (TAS).

Figure 14-9. Take-off distance chart (Sheet 7 of 8)





# TAKE-OFF DISTANCE — FEET



MAXIMUM PERFORMANCE - TWO FOOT SKID HEIGHT - HOVERING TECHNIQUE  
TAKE-OFF POWER - 6600 RPM

Model(s): AH-1G  
Data as of: JULY 1966  
DATA BASIS: ESTIMATED

Engine(s): Lycoming T53-L-11  
Fuel Grade: JP-4  
Fuel Density: 6.5 LB/GAL.

GROSS WT. LB.	PRESSURE ALTITUDE 1000 FEET	-25° C (-13° F)		-5° C (+23° F)		+15° C (+59° F)		+35° C (+95° F)		+55° C (+131° F)						
		CLIMB OUT SPEED TAS KNOTS	DIST TO CLEAR 50 FT.	CLIMB OUT SPEED TAS KNOTS	DIST TO CLEAR 50 FT.	CLIMB OUT SPEED TAS KNOTS	DIST TO CLEAR 50 FT.	CLIMB OUT SPEED TAS KNOTS	DIST TO CLEAR 50 FT.	CLIMB OUT SPEED TAS KNOTS	DIST TO CLEAR 50 FT.	CLIMB OUT SPEED TAS KNOTS	DIST TO CLEAR 50 FT.			
9500	0	30	309	30	318	30	407									
	2000	30	318	30	337											
	4000	30	335	30	556											
9500	6000	30	461													

REMARKS:

1. No wind.
2. Take-off distance is zero when hovering out-of-ground effect is possible.
3. No take-off distance is shown where hovering with 2-foot skid height is not possible.
4. Take-off distance will exceed those shown if hovering in-ground-effect is performed for over one minute immediately prior to take-off.
5. Speed over the 50-foot obstacle is True Airspeed (TAS).

Figure 14-9. Take-off distance chart (Sheet 8 of 8)







